

Table of
Contents

Introduction

- 5 Welcome
- 6 Communication with the University

- 7 Shawnee State University: Past and Present
- 7 Mission Statement
- 8 Goals
- 8 Enduring Vision Statements
- 9 Accreditations and Approvals

Calendar

- 10 1993-94 Academic Calendar
- 12 1994-95 Academic Calendar

Services, Fees, and Facilities

- 16 Admission to the University
- 26 Orientation
- 27 Registration
- 28 Fees and Expenses
- 31 Financial Aid
- 35 Academic Policies and Information
- 42 Counseling
- 44 Transfer/University Parallel Programs
- 44 Developmental Education
- 45 Learning Center
- 45 Athletics
- 46 Student Activities
- 47 Identification Cards
- 47 Bookstore
- 47 Library
- 47 University Center
- 48 Housing
- 48 Continuing Education
- 51 Upward Bound
- 51 Tech Prep Ohio South Consortium
- 51 Project Discovery

Academic Programs

- 52 Center for Integrative Studies
- 52 General Education Core
- 56 Programs of Study at Shawnee State

College of Arts and Sciences

- 58 Mission
- 58 Degrees Offered
- 59 Faculty: A Commitment to Teaching, Scholarship/Research and Creative Activities, and Service
- 59 Selecting and Declaring a Degree Major
- 59 Academic Advising
- 60 Baccalaureate Degree Requirements
- 60 Minors
- 60 Associate Degree Requirements
- 60 Preparation for Elementary Education Certification
- 60 Course Scheduling and Offerings
- 60 Pass/No-Credit Policy
- 61 Department of Arts and Humanities
- 61 Mission
- 61 Bachelor of Arts, Major in English/Humanities
- 64 Elementary Education Certification
- 65 Associate Degree Programs

College of Arts and Sciences (cont'd.)

- 67 Department of Mathematics
- 67 Mission
- 67 Bachelor of Science in Natural Science
- 67 Mathematics at Shawnee State University
- 68 Elementary Education Certification
- 69 Associate Degree Programs
- 71 Department of Natural Sciences
- 71 Mission
- 71 Bachelor of Science in Natural Science
- 72 Elementary Education Certification
- 73 Certificate Programs and Minors in Science
- 74 Associate Degree Programs
- 76 Department of Social Sciences
- 76 Mission
- 76 Bachelor of Arts, Major in Social Science
- 77 Elementary Education Certification
- 77 Bachelor of Arts in Social Science, 2 + 2 for Students Who Complete the Legal Assisting Program
- 78 Associate Degree Programs

College of Business

- 82 Mission
- 82 Degrees Offered
- 82 Bachelor of Science in Business Administration, Major in General Business
- 86 Associate Degree in Applied Business
- 86 Accounting Technology
- 89 Business Management Technology
- 92 Computer Information Systems in Business
- 94 Office Administration Technology
- 95 Legal Assisting Technology
- 96 Associate of Individualized Studies Degree

College of Engineering Technologies

- 98 Mission
- 98 Degrees Offered
- 99 Engineering Technology Programs at Shawnee State
- 99 Pass/No-Credit Policy
- 99 Bachelor of Science in Electrical and Computer Engineering Technology
- 104 Bachelor of Science in Plastics Engineering Technology
- 107 Associate of Applied Science in Computer Aided Design
- 109 Associate of Applied Science in Electromechanical Engineering Technology
- 111 Associate of Applied Science in Instrumentation and Control Engineering Technology
- 113 Associate of Applied Science in Plastics Engineering Technology
- 115 Computer Aided Drafting and Design Technician Program, One-year Certificate

Table of Contents

Table of
Contents

**College of Engineering
Technologies (cont'd.)**

- 116 Plastics Engineering Technology,
One-year Certificate
- 117 Minor in Plastics Engineering Technology
- 117 Minor and Certificate in Computer
Technology
- 119 Associate of Individualized Studies
Degree
- 119 Pre-Engineering Curriculum

College of Health Sciences

- 122 Mission
- 122 Degrees Offered
- 122 Bachelor of Applied Science,
Concentration in Health Management
- 124 Bachelor of Science in Occupational
Therapy
- 129 Minimum Admission Requirements for
Associate Degree Programs
- 131 Health Science Class Schedule
- 131 Pass/No-Credit Policy
- 131 Guidelines for Appealing a Dismissal
- 132 Associate Degree Nursing
- 133 Dental Hygiene
- 135 Emergency Medical Technology
- 138 Medical Laboratory Technology
- 140 Occupational Therapy Assistant
- 143 Physical Therapist Assistant
- 144 Radiologic Technology
- 146 Respiratory Therapy
- 148 Associate of Individualized Studies
Degree

Center for Teacher Education

- 150 Mission
- 150 Elementary Education Certification
Requirements
- 151 Eligibility Criteria for Admission to
the Teacher Education Program
- 151 Pass/No-Credit Policy
- 151 Course Scheduling
- 151 Elementary Education Certification
Program Curriculum
- 152 Health, Physical Education, and
Recreation
- 153 English/Humanities Major
- 154 Mathematics Major
- 154 Natural Science Major
- 155 Social Science Major

Course Descriptions

- 157 Explanation of Prerequisites
- 157 Explanation of Abbreviations
- 158 Course Descriptions

Trustees and Staff

- 232 Board of Trustees
- 232 Administration
- 234 Faculty

Application

- 240 Instructions
- 241 Application for Admission

Index

243



Welcome

This catalog contains the key that will open the doors of your future.

Between its covers, you'll find the history and mission of Shawnee State, the academic year calendar, admission information, degree and graduation requirements, fees and how to pay them through financial aid, and information about many of the folks who are dedicated to helping you become a college-educated person.

But, best of all, you will find course descriptions. Each one represents a small key to knowledge. When the courses are combined to meet graduation requirements, they form a single master key to the high quality of life that a college education brings you.

I strongly encourage you to open as many doors as possible during your studies at Shawnee State. Explore. Experiment. Enjoy. Step into classes outside your major and into someone else's major and become excited about learning. I challenge you to make your dream of a better life a reality.

Clive C. Veri

Clive C. Veri
President

Mailing Address Shawnee State University
940 Second Street
Portsmouth, Ohio 45662-4303

Telephone Number (614) 354-3205
FAX Number [614] 355-2416

Communication with Shawnee State will be easier if your first message is addressed to the officers named below. The telephone numbers listed provide direct access to those offices.

Academic Assessment Services (Placement Tests): *Learning Center* • 355-2499
Admission: *Director* • 355-2221
Alumni Affairs: *Director, Development and Community Relations* • 355-2257
Arts and Humanities, Department of: *Chairperson* • 355-2300
Arts and Sciences, College of: *Dean* • 355-2554
Athletics, Intercollegiate and Intramural: *Director* • 355-2285
Books: *Bookstore Manager* • 355-2418
Business, College of: *Dean* • 355-2215
Business Office (payment of bills): *Bursar* • 355-2279
Cafeteria: *Manager* • 355-2578
Campus Tours: *Director, Admission* • 355-2221 or 355-2557
Career Planning: *Director, Counseling and Career Services* • 355-2259
Center for Integrative Studies: *Coordinator* • 355-2554
Center for Teacher Education: *Dean* • 355-2451
Clubs and Organizations: *Director, Student Activities* • 355-2217
Continuing Education: *Director* • 355-2494
Counseling: *Director, Counseling and Career Services* • 355-2259
Dental Hygiene Clinic: • 355-2241
Developmental Education: *Director* • 355-2277
Disability Services: *Coordinator* • 355-2456
Donations, Gifts, Bequests: *Director, Development and Community Relations* • 355-2284
Engineering Technologies, College of: *Dean* • 355-2224
Financial Aid: *Director* • 355-2237
G.R.O.W. Program: *Coordinator* • 355-2370
Health Sciences, College of: *Dean* • 355-2225
Housing: *Director, Student Activities* • 355-2217
International Students: *Advisor* • 355-2221
JOBS Student Retention Program: *Director* • 353-6400
Library/Media Services: *Director* • 355-2323
Mathematics, Department of: *Chairperson* • 355-2301
Minority Affairs: *Coordinator* • 355-2276
Natural Sciences, Department of: *Chairperson* • 355-2301
Orientation, New Student: *Registrar* • 355-2262
Personnel, Faculty: *Provost* • 355-2260
Personnel, Staff: *Director, Personnel* • 355-2420
Presidential and Trustee Affairs: *President* • 355-2289
Project Discovery: *Coordinator* • 355-2239
Registration: *Registrar* • 355-2262
Sports Center: *Athletic Director* • 355-2285
Social Sciences, Department of: *Chairperson* • 355-2234
Student Affairs: *Vice President* • 355-2280
Student Employment: *Director of Career Planning and Placement* • 355-2213
Student Newspaper: *Editor* • 355-2278
Student Senate: *President* • 355-2320
Student Support Services: *Director* • 355-2276
Tech Prep: *Director* • 355-2281
Transcripts: *Registrar* • 355-2262
Transfer Admission: *Director, Transfer Placement* • 355-2540
Tutoring: *Learning Center* • 355-2499
University Center: *Information Desk* • 355-2545
Upward Bound: *Director* • 355-2439
Veterans Coordinator: *Director, Financial Aid* • 355-2237

Shawnee State University: Past and Present

In January of 1975, Shawnee State General and Technical College, created from a merger of the Ohio University regional campus and Scioto Technical College, was chartered by the Ohio Board of Regents to begin operation on July 1, 1975. The college, then operated on two campuses, moved to its present location in 1978. By an act of the Ohio Legislature (Senate Bill 229) on November 4, 1977, Shawnee State General and Technical College became Shawnee State Community College. Then in 1986, another act of the Legislature, put in effect on July 2, created Shawnee State University. Since then, efforts by the regional state university in south central Ohio to incorporate baccalaureate degree programs with the already successful associate degree programs have been ongoing.

Located on the Ohio River in downtown Portsmouth, Shawnee State is currently in the midst of a massive campus expansion plan that, by the year 2000, will have brought more than \$100 million to the University for new buildings, landscaping, land acquisition, and parking.

The campus, which began with a single, five-story, classroom building, has expanded to include 15 additional buildings. Newest among them are the Library, opened in June of 1991, the University Center, opened in March, 1992, and the Vern Riffe Advanced Technology Center, opened in September, 1992.

A master plan created by Bohm-NBBJ of Columbus, Ohio, with input from Shawnee State and Portsmouth area community members, has created the vision for the institution's growth plans. Steps toward its completion continue today as a link between the James A. Rhodes Sports Center and the Activities Center, the Second Street relocation project, and the Center for the Arts are either currently under construction or being designed.

To accommodate the diverse educational needs of an expanding student population, Shawnee State's academic curriculum has continued to grow. Highlights of the 1992-1993 academic year include the proposal of a baccalaureate degree in occupational therapy, the development of a bachelor of fine arts, and a new arrangement whereby graduates of the associate degree in legal assisting can complete a baccalaureate degree in social sciences in two additional years.

The University now offers associate degrees in 17 major fields, baccalaureate degrees in 6 major fields, certification in elementary education, and is in the process of developing additional majors.

The Continuing Education Department has grown steadily as well, to the point where more than 7,000 participants will have taken part during the 1992-93 academic year. Programs geared toward academically talented children have proven more popular year after year, and Shawnee State's Dislocated Workers Program has become a model throughout the state and beyond.

The University has also grown in importance and sphere of influence in other ways as well by offering high quality cultural and educational events to students and the community at large.

Mission Statement

Shawnee State University prepares students for the changing needs of business, industry, education, and society through its diversified degree programs. Recognizing the importance of knowledge, values, and cultural enrichment, Shawnee State University is committed to teaching students to think critically, to act ethically, and to communicate effectively. The University fosters scholarly inquiry, integrative learning, and an interdisciplinary approach to knowledge. To enrich the lives of the community, the University provides opportunities for continuing personal and professional development, intellectual discovery, and appreciation for the creative and performing arts.

Goals

Shawnee State is a student-oriented university with a central emphasis on teaching and learning. Within this context, Shawnee State is committed to the goals of:

- offering affordable and accessible four-year and two-year degree programs and one-year certificate programs.
- providing continuously improved learning opportunities, guided by excellent teaching, academic advising, and counseling for students of various ages, diverse backgrounds, and different needs.
- offering academic and student life programs that provide opportunities for intellectual, personal, ethical, cultural, and social development.
- providing public service in traditional and continuing education programs to encourage the development of outreach and cooperative education efforts.
- coordinating the growth and emphasis of its programs with long-range plans and the needs of the regional, state, national, and international community.
- responding to the changing needs of society by establishing appropriate feedback networks and linkages with practicing professionals, business, industry, community service agencies, and other educational institutions.
- providing a stimulating environment for its students, faculty, and staff that empowers them to explore their potential. This environment is strengthened by the collegial interaction of people within the University and broader community.

In meeting these goals, all members of the Shawnee State community are engaged in continuing professional development that aids them in becoming better human beings as well as better educators. This includes scholarship, which informs all our other activities, along with creative activities, applied research, and community involvement. Our efforts remain focused on providing the highest quality teaching-learning environment possible.

Enduring Vision Statements

A plan—especially a strategic plan—describes a destination. In 1989, the Shawnee State academic community embarked on a planning process which recommitted Shawnee State to its mission and established a set of goals intended to implement that mission. The enduring vision statements presented here, and adopted by the Shawnee State University Board of Trustees, are a natural outgrowth of that introspection and describe “what ought to be.”

- Recognizing its emerging role and scope, Shawnee State University will become established as THE Regional State University for Southcentral Ohio with visibility on a statewide and national level in select academic areas.
- Recognizing its responsibility to meet the educational needs of the citizens of the region, Shawnee State University will provide a comprehensive higher educational experience for its students.
- Knowing that its reputation stands on the quality of its academic programs, Shawnee State University will establish and maintain academic programs supportive of a focused academic mission founded primarily on technological, career oriented, and professional programs, including the liberal arts and sciences, which innovatively address the needs of the region.
- The continued strong development of Shawnee State University can only be accomplished through constructive collaboration among all constituencies, particularly those internal to the University. Such collegial collaboration can best occur in an environment in which all members are

knowledgeable, treated equitably, and consider themselves a true and respected part of the future of the campus community. Accordingly, Shawnee State University will act to improve communication and coordination among members of the university community with a goal of informed decision making.

- Shawnee State University will enhance and manage the resources available to it in a manner that facilitates the attainment of its vision.

Strategies for implementing these enduring vision statements are included in *A View of the Future: Guidelines for Strategic Planning at Shawnee State University*, available in the Shawnee State Library or in the University's administrative offices.

Accreditations and Approvals

Shawnee State University is accredited by the North Central Association of Colleges and Schools to offer baccalaureate and associate degrees and certificates.

In addition, the institution or specific programs are accredited or approved by the following agencies:

American Dental Association, Commission on Dental Accreditation
 American Medical Association, Committee on Allied Health Education and Accreditation, Joint Review Committee on Education in Radiologic Technology
 American Medical Association, Committee on Allied Health Education and Accreditation, Joint Review Committee for Respiratory Therapy Education
 American Occupational Therapy Association
 Commission on Accreditation in Physical Therapy Education
 College Entrance Examination Board
 Ohio Board of Nursing
 Ohio Board of Regents
 Ohio College Association
 Ohio Department of Highway Safety, Division of Public Safety Services (EMT-A and Paramedic training programs)
 Social Security Department
 State of Ohio, Department of Education
 State of Ohio, Department of Education, Division of Vocational Education
 United States Department of Education



1993-94 Academic Calendar

Summer Quarter, 1993

April 28	Advance registration opens for summer and fall quarters
May 12	Advance registration closes for summer quarter
May 26	Early registration for summer quarter
June 24	Late registration for summer quarter (\$25 late fee if enrolled spring quarter)
June 25	Last day to pay fees for summer quarter (\$20 late fee after this date)
June 28	First day of classes; Last day for 100% refund for complete withdrawal from full summer quarter and first five-week session;
June 30	Last day to apply for Budget Payment Plan Last day to add a class (first five-week session); Last day to apply for pass/fail (first five-week session)
July 2	Last day to add a class (full summer quarter session); Last day to apply for pass/fail (full summer quarter session); Last day for 60% refund of instructional fees for complete withdrawal from first five-week session
July 4	Independence Day
July 5	Independence Day Holiday — University closed
July 6	Last day for 80% refund of instructional fees for complete withdrawal from full summer quarter session
July 9	Advance registration closes for fall quarter
July 21	Last day to drop a class (first five-week session)
July 30	Last day of first five-week session; Final exams for first five-week session
August 2	First day of second five-week session; Grades due to Office of the Registrar by noon (first five-week session); Last day for 100% refund for complete withdrawal from second five-week session
August 10 - 11	Early registration for fall quarter
August 13	Last day to apply for non-credit (full summer quarter session)
August 16	Last day to drop a class (full summer quarter session)
September 3	Summer quarter ends
September 6	Labor Day — University closed
September 7	Final exams for full quarter and second five-week sessions
September 9	Grades due to Office of the Registrar by noon (full summer quarter and second five-week sessions)

Fall Quarter, 1993

April 28	Advance registration opens for fall quarter
July 9	Advance registration closes for fall quarter
August 10 - 11	Early registration for fall quarter
September 6	Labor Day — University closed
September 16	First day of Rosh Hashanah — University open
September 21	Late registration for fall quarter (\$25 late fee if enrolled summer quarter)
September 24	Last day to pay fees for fall quarter (\$20 late fee after this date); Last day for 100% refund for complete withdrawal from fall quarter

Fall Quarter, 1993 (cont'd.)

September 25	Yom Kippur — University open
September 27	First day of classes; First day for 80% refund of instructional fees for complete withdrawal from fall quarter
September 28	Last day to apply for Budget Payment Plan
October 1	Last day to add a class
October 4	Last day to apply for fall quarter graduation
October 8	Last day for 80% refund of instructional fees for complete withdrawal from fall quarter; Last day to apply for pass/fail
October 11	Columbus Day — University open
November 1	Advance registration opens for winter quarter
November 11	Veterans Day — University closed
November 12	Last day to apply for non-credit
November 15	Last day to drop a class
November 19	Advance registration for winter quarter closes at noon
November 25	Thanksgiving Day — University closed
November 26	University Closed (<i>in lieu of Columbus Day</i>)
December 1	Early registration for winter quarter
December 3	Fall quarter ends; Last day to apply for winter quarter graduation
December 6 - 10	Final exams
December 9	First day of Hanukkah — University open
December 13	Grades due to Office of the Registrar by noon
December 23	Christmas Holiday — University closed
December 24	University Closed (<i>in lieu of President's Day</i>)
December 25	Christmas Day

Winter Quarter, 1993-94

November 1	Advance registration opens for winter quarter
November 19	Advance registration for winter quarter closes at noon
December 3	Last day to apply for winter quarter graduation
December 30	Last day to pay fees for winter quarter (\$20 late fee after this date)
December 31	New Year's Holiday — University closed
January 3	Late registration for winter quarter (\$25 late fee if enrolled fall quarter); Last day for 100% refund for complete withdrawal from winter quarter
January 5	First day of classes; Last day to apply for Budget Payment Plan; First day of 80% refund of instructional fees for complete withdrawal from winter quarter
January 10	Last day to add a class
January 17	Martin Luther King Day — University closed
January 18	Last day to apply for pass/fail
January 28	Last day to apply for spring quarter graduation (and participate in June commencement)
January 31	Advance registration opens for spring quarter
February 18	Advance registration for spring quarter closes at noon
February 21	President's Day — University open; Last day to apply for non-credit

Winter Quarter, 1993-94 (cont'd.)

March 10	Early registration for spring quarter
March 14	Winter quarter ends
March 15 - 21	Final exams
March 23	Grades due to Office of the Registrar by noon

Spring Quarter, 1994

January 28	Last day to apply for spring quarter graduation (and participate in June commencement)
January 31	Advance registration opens for spring quarter
February 18	Advance registration for spring quarter closes at noon
March 10	Early registration for spring quarter
March 28	Last day to pay fees for spring quarter (\$20 late fee after this date)
March 29	Late registration for spring quarter (\$25 late fee if enrolled winter quarter); Last day for 100% refund for complete withdrawal from spring quarter
March 30	First day of classes; First day for 80% refund of instructional fees for complete withdrawal from spring quarter; Last day to apply for Budget Payment Plan
April 1	Good Friday — University open
April 3	Easter — University closed
April 6	Last day to add a class
April 12	Last day to apply for pass/fail
April 13	Last day for 80% refund of instructional fees for complete withdrawal from spring quarter
May 4	Advance registration opens for summer and fall quarters
May 17	Last day to apply for non-credit
May 18	Last day to drop a class; Advance registration for summer quarter closes at noon
May 25	Early registration for summer quarter
May 30	Memorial Day — University closed
May 31	Spring quarter ends
June 1 - 7	Final exams
June 9	Grades due to Office of the Registrar by noon; Commencement practice
June 10	Commencement
June 16	Late registration for summer quarter

1994-95 Academic Calendar

The following schedule for the 1994-95 academic year is tentative and subject to change.

Summer Quarter, 1994

May 4	Advance registration opens for summer and fall quarters
May 18	Advance registration for summer quarter closes at noon
May 25	Early registration for summer quarter
June 16	Late registration for summer quarter (\$25 late fee if enrolled spring quarter)

Summer Quarter, 1994 (cont'd.)

June 17	Last day to pay fees for summer quarter (\$20 late fee after this date)
June 20	First day of classes; Last day for 100% refund for complete withdrawal from full summer quarter and first five-week sessions; Last day to apply for Budget Payment Plan
June 22	Last day to add a class (first five-week session); Last day to apply for pass/fail (first five-week session)
June 24	Last day to add a class (full summer quarter session); Last day to apply for pass/fail (full summer quarter session); Last day for 60% refund of instructional fees for complete withdrawal from first five-week session
June 27	Last day for 80% refund of instructional fees for complete withdrawal from full summer quarter session
July 4	Independence Day — University closed
July 8	Advance registration for fall quarter closes at noon
July 13	Last day to drop a class (first five-week session)
July 22	Last day of first five-week session; Final exams for first five-week session
July 25	First day of second five-week session; Grades due to Office of the Registrar by noon (first five-week session); Last day for 100% refund for complete withdrawal from second five-week session
August 1	Last day to apply for summer graduation
August 5	Last day to apply for non-credit (full summer quarter session)
August 8	Last day to drop a class (full summer quarter session)
August 10 - 11	Early registration for fall quarter
August 26	Summer quarter ends
August 29 - 30	Final exams for full summer quarter and second five-week sessions
September 1	Grades due to Office of the Registrar by noon (full summer quarter and second five-week sessions)

Fall Quarter, 1994

May 4	Advance registration opens for fall quarter
July 8	Advance registration for fall quarter closes at noon
August 10 - 11	Early registration for fall quarter
September 5	Labor Day — University closed
September 6	First day of Rosh Hashanah — University open
September 14	Late registration for fall quarter (\$25 late fee if enrolled summer quarter)
September 15	Yom Kippur — University open
September 16	Last day to pay fees for fall quarter (\$20 late fee after this date); Last day for 100% refund for complete withdrawal from fall quarter
September 19	First day of classes; First day for 80% refund of instructional fees for complete withdrawal from fall quarter; Last day to apply for Budget Payment Plan
September 23	Last day to add a class

Fall Quarter, 1994 (cont'd.)

September 30	Last day to apply for fall quarter graduation; Last day for 80% refund of instructional fees for complete withdrawal from fall quarter; Last day to apply for pass/fail
October 10	Columbus Day — University open
October 31	Advance registration opens for winter quarter
November 4	Last day to apply for non-credit
November 7	Last day to drop a class
November 10	Advance registration for winter quarter closes at noon
November 11	Veterans Day — University closed
November 22	Early registration for winter quarter
November 23	Fall quarter ends
November 24	Thanksgiving Day — University closed
November 25	University closed (<i>in lieu of Columbus Day</i>)
November 28	First day of Hanukkah — University open
Nov. 28 - Dec. 2	Final exams
December 5	Grades due to Office of the Registrar by noon
December 6	Last day to apply for winter quarter graduation
December 25	Christmas Day
December 26	University closed (<i>in lieu of President's Day</i>)
December 27	Christmas Holiday — University closed

Winter Quarter, 1994-95

October 31	Advance registration opens for winter quarter
November 10	Advance registration for winter quarter closes at noon
December 6	Last day to apply for winter quarter graduation
December 30	Last day to pay fees for winter quarter (\$20 late fee after this date)
January 2	New Year's Holiday — University closed
January 3	Late registration for winter quarter (\$25 late fee if enrolled fall quarter); Last day for 100% refund for complete withdrawal from winter quarter
January 4	First day of classes; Last day to apply for Budget Payment Plan; First day of 80% refund for complete withdrawal from winter quarter
January 10	Last day to add a class
January 16	Martin Luther King Day — University closed
January 17	Last day for 80% refund of instructional fees for complete withdrawal from winter quarter; Last day to apply for pass/fail
January 31	Last day to apply for spring quarter graduation (and participate in June commencement)
February 1	Advance registration opens for spring quarter
February 15	Advance registration for spring quarter closes at noon
February 20	President's Day — University open
February 21	Last day to apply for non-credit
February 22	Last day to drop a class
March 1	Ash Wednesday — University open
March 8	Early registration for spring quarter

Winter Quarter, 1994-95 (cont'd.)

March 14	Winter quarter ends
March 15 - 21	Final exams
March 23	Grades due to Office of the Registrar by noon

Spring Quarter, 1995

January 31	Last day to apply for spring quarter graduation (and participate in June commencement)
February 1	Advance registration opens for spring quarter
February 15	Advance registration for spring quarter closes at noon
March 8	Early registration for spring quarter
March 27	Last day to pay fees for spring quarter (\$20 late fee after this date)
March 30	Late registration for spring quarter (\$25 late fee if enrolled winter quarter)
March 31	Last day for 100% refund for complete withdrawal from spring quarter
April 1	Good Friday — University open; First day for 80% refund of instructional fees for complete withdrawal from spring quarter
April 2	Easter — University closed
April 3	First day of classes; Last day to apply for Budget Payment Plan
April 7	Last day to add a class
April 14	Last day to apply for pass/fail; Last day for 80% refund of instructional fees for complete withdrawal from spring quarter
May 8	Advance registration opens for summer and fall quarters
May 19	Last day to apply for non-credit; Advance registration for summer quarter closes at noon
May 22	Last day to drop a class
May 29	Memorial Day — University closed
June 9	Spring quarter ends
June 12 - 16	Final exams
June 16	Commencement
June 19	Grades due to Office of the Registrar by noon; Late registration for summer quarter



Admission to the University

Admission to degree programs at Shawnee State University is open to graduates who hold a state-approved diploma from state chartered or regionally accredited high schools and to students who have earned high school equivalency through the General Education Development (GED) program. However, admission to the University does not guarantee admission to specific programs of study. Students who intend to apply for admission to programs in the College of Health Sciences should refer to the appropriate section of this catalog for specific admission requirements.

Admission to students not seeking a degree at Shawnee State University is also open. The minimum requirements for admission of all students, both degree seeking and non-degree seeking, include:

- a completed application for admission
- the current non-refundable application fee

There are varying additional requirements for students in different categories, including recent high school graduates, transfer students, special non-degree students, transient students, international students, and eligible students who are still attending high school. Requirements for each are discussed in the following sections.

It is recommended that the high school background of the entering freshman pursuing a degree include:

- 4 units English
- 3 units mathematics (algebra 1 and 2, geometry)
- 3 units social studies
- 3 units science
- 2 units foreign language
- 1 unit visual, performing arts (drama, music, art)

These courses are recommendations, not requirements. However, students who have deficiencies in English or mathematics will be required to take developmental courses prior to attempting college level work.

Degree and Certificate Students

All students pursuing the four-year baccalaureate or two-year associate degrees or the one-year certificate are required to have scores from the ACT or SAT forwarded to Shawnee State University. Only applicants who are 21 years of age or older, as of the first day of their first quarter of enrollment, are exempt from providing ACT or SAT scores.¹

Although Shawnee State University has an open admission policy and does not use the ACT or SAT for determining admission to the University, it does require results of these tests for use in advisement and placement. Students who have not yet taken the ACT or SAT may contact the Shawnee State University Admission Office for information about future ACT test dates. Applicants who have not taken the ACT or SAT will be accepted as "provisional students" but must take the ACT during the initial quarter of enrollment. Students who have not taken the ACT by the end of their first quarter of attendance will not be permitted to register for subsequent quarters.

Recent High School Graduates

High school graduates who have been awarded a state-approved diploma are required to submit a **final, official transcript** of academic work to Shawnee State University. Students may send a high school transcript request form (available in

¹ The American College Test (ACT) is required of all applicants for admission to some of the health sciences programs. Specific information about required scores is stated in that section of the catalog.

the Admission Office) or a written request to the high school requesting an official transcript to be forwarded directly to the University.

Transcripts should be mailed to the following address: Office of Admission, Shawnee State University, 940 Second Street, Portsmouth, Ohio 45662-4303. **Transcripts must be received directly from the high school. Photocopies and hand-carried transcripts will not be accepted.** High school transcripts must be received no later than the end of the initial quarter of enrollment. Students who have not had their final high school transcripts forwarded by the end of their first quarter of enrollment will not be permitted to register for subsequent quarters until all missing materials have been provided.

Advanced Placement

Students may be awarded college credit for satisfactory performance on certain proficiency examinations. Each May, participating high schools provide their students with an opportunity to take examinations in a variety of subject matter areas through The Advanced Placement Program (AP™), sponsored by the College Board and administered by Educational Testing Service (ETS). Students achieving a grade of 3 or above may receive college credit on the basis of these examinations. Credit given through the AP program does not apply toward the residency requirement for graduation.

In addition, Shawnee State University recognizes that some courses completed in high school or vocational school may be equivalent to some entry-level coursework at Shawnee State. In order to avoid repetition of such courses and to encourage advanced study in the respective disciplines, Shawnee State has entered into "Articulation Agreements" with high schools, vocational schools, and school districts. This allows the award of advanced placement credit for certain coursework completed at the high school where articulation agreements are in place. Such credit waives the student's course requirement. A more advanced class must be completed to replace the waived course.

Please contact the director of transfer placement for information concerning eligibility for credit through advanced placement.

Applicants with the GED

Students who have successfully completed the GED may use the special GED transcript request form (available in the admission office) to have official GED transcripts sent to the University or they may request official transcripts directly from the State GED Office, Ohio Department of Education, 65 South Front Street, Room 812, Columbus, Ohio 43266-0308 or State GED Office, Kentucky Department of Education, Frankfort, Kentucky 40601.

Transcripts should be mailed to the following address: Office of Admission, Shawnee State University, 940 Second Street, Portsmouth, Ohio 45662-4303. **Transcripts must be received directly from the State GED Office. Photocopies and hand-carried transcripts will not be accepted.**

Undeclared Major/Undecided Student

Students who intend to pursue a degree but are undecided as to a major may remain "undeclared" until they earn their first 45 quarter hours of credit. At the completion of 45 hours, undeclared students are required to declare a major or be prohibited from registering for classes.

Transfer Students

Students who have attended other regionally-accredited colleges or universities may transfer to Shawnee State University provided they were in good academic standing at the institution attended most recently. In addition to the application



for admission, application fee, and official high school transcript, transfer students are required to provide an official transcript from each college or university previously attended. **High school, GED, and college transcripts must be received directly from those institutions. Photocopies and hand-carried transcripts will not be accepted.** Transfer students may be admitted as "provisional students" until such time as the official transcripts are received from all previous colleges.

Transfer students who have earned fewer than 45 quarter hours of credit and are under 21 years of age, as of the first day of their first quarter of enrollment, are required to take the ACT. They may attend Shawnee State as "provisional students" but must take the ACT during the initial quarter of enrollment. Transfer students who must take the ACT and have not taken it by the end of their first quarter of attendance will not be permitted to register for subsequent quarters.

Credits applicable to the curriculum for which the student is applying which were earned at regionally accredited colleges or universities are accepted at the time of admission. Generally, courses completed with a grade of "C" or better are eligible for transfer. Under certain circumstances, a "D" may be transferable. See the director of transfer placement for further information. The credit hours transferred do not become a part of the grade point average at Shawnee State University.

To receive transfer credit, the student must file an official transcript of previous college work. A student must earn a minimum of 30 credit hours at Shawnee State University to be considered for the award of an associate degree and a minimum of 45 credit hours to be considered for the award of a baccalaureate degree.

Students who have attended non-regionally accredited colleges or universities may transfer to Shawnee State University provided they meet all admission standards applicable to other transfer students. Credits applicable to the curriculum for which the student is applying which were earned at non-regionally accredited institutions will be considered for acceptance as transfer credit if:

- the student has completed the associate degree at that institution, and
- the student validates the award of credit by completing, with a grade of "C" or better, a planned program of courses totaling a minimum of 30 credit hours applicable to a four-year curriculum as approved by the director of transfer placement. For students transferring credit from non-regionally accredited colleges or universities, a maximum of 90 quarter hours will be considered for transfer.

State Policy On Articulation and Transfer

Institutional Transfer. The Ohio Board of Regents, following the directive of the Ohio General Assembly, has developed a new statewide policy to facilitate movement of students and transfer credits from one Ohio public college or university to another. The purpose of the State Policy is to avoid duplication of course requirements and to enhance student mobility throughout Ohio's higher education system. Since independent colleges and universities in Ohio may or may not be participating in the transfer policy, students interested in transferring to an independent institution are encouraged to check with the college or university of their choice regarding transfer agreements.

Transfer Module. The new Ohio Board of Regents' Transfer and Articulation Policy established the Transfer Module, which is a specific subset or the entire set of a college or university's general education requirements. The Transfer Module contains 54-60 quarter hours or 36-40 semester hours of specified course credits in English composition, mathematics, fine arts, humanities, social science, behavioral science, natural science, physical science, and interdisciplinary coursework.

A transfer module completed at one college or university will automatically meet the requirements of the transfer module at the receiving institution, once the student is accepted. Students may be required, however, to meet additional general education requirements that are not included in the Transfer Module.

Conditions for Transfer Admission. Students meeting the requirements of the Transfer Module are subject to the following conditions:

1. The policy encourages receiving institutions to give preferential consideration for admission to students who complete the Transfer Module and either the Associate of Arts or the Associate of Science degrees. These students will be able to transfer all courses in which they received a passing grade of "D" or better. Students must have an overall grade point average of 2.0 to be given credit for the Transfer Module.
2. The policy also encourages receiving institutions to give preferential consideration for admission to students who complete the Transfer Module with a grade of "C" or better in each course and 90 quarter hours or 60 semester hours. Students must have an overall grade point average of 2.0 to be given credit for the Transfer Module and only courses in which a "C" or better has been earned will transfer.
3. The policy encourages receiving institutions to admit, on a non-preferential consideration basis, students who complete the Transfer Module with a grade of "C" or better in each course and less than 90 quarter hours or 60 semester hours. These students will be able to transfer all courses in which they received a grade of "C" or better.

Admission to a given institution, however, does not guarantee that a transfer student will be automatically admitted to all majors, minors, or fields of concentration at that institution. Once admitted, transfer students shall be subject to the same regulations governing applicability of catalog requirements as all other students. Furthermore, transfer students shall be accorded the same class standing and other privileges as native students on the basis of the number of credits earned. All residency requirements must be successfully completed at the receiving institution prior to the granting of a degree.

Responsibilities of Students. In order to facilitate transfer with maximum applicability of transfer credit, prospective transfer students should plan a course of study that will meet the requirements of a degree program at the receiving institution. Specifically, students should identify early in their collegiate studies an institution and major to which they desire to transfer. Furthermore, students should determine if there are language requirements or any special course requirements that can be met during the freshman or sophomore year. This will enable students to plan and pursue a course of study that will articulate with the receiving institution's major. Students are encouraged to seek further information regarding transfer from both their advisor and the college or university to which they plan to transfer.

Appeals Process. A multi-level, broad based appeal process is required to be in place at each institution. A student disagreeing with the application of transfer credit by the receiving institution shall be informed of the right to appeal the decision and the process for filing the appeal. Each institution shall make available to students the appeal process for that specific college or university.

If a transfer student's appeal is denied by the institution after all appeal levels within the institution have been exhausted, the institution shall advise the student in writing of the availability and process of appeal to the state level Articulation and Transfer Appeals Review Committee.

The Appeals Review Committee shall review and recommend to institutions the resolution of individual cases of appeal from transfer students who have exhausted all local appeal mechanisms concerning applicability of transfer credits at receiving institutions.

Services,
Fees, and
Facilities

Shawnee State University Transfer Module

Field	General Education Requirements Applied to TM Minimums	Additional General Education Requirements Counted in TM (12-14 sem., 18-24 qtr.)	Additional General Education Requirements Beyond the TM for Graduation
English minimum 6 qtr./3 sem.	ENGL 111S (4) ENGL 112S (4)	8 ENGL 232 (3) ENGL 240 (3) ENGL 245 (3)	ENGL 115S (4)
Mathematics minimum 3 qtr./3 sem.	MATH 110S (4)	4 MATH 131 (4) MATH 132 (4) MATH 201 (4) MATH 202 (4) MATH 250 (4) MATH 255 (4)	
Arts/Humanities minimum 9 qtr./6 sem.	ENGL/HIST 225S (4) and two of the following: ARTS 261 (4) ARTS 262 (4) MUSI 220 (3) PHIL 101 (4) ENGL 200 (4)	12 ENGL 203 (4) ENGL 210 (4) ENGL 211 (4) ENGL 212 (4) MUSI 221 (3) MUSI 222 (3) MUSI 223 (3) PHIL 102 (4) PHIL 103 (4) PHIL 105 (4)	ENGL/HIST 227S (4) PHIL 320S (4)
Social Science minimum 9 qtr./6 sem.	SOCI 110S (4) and HIST/ENGL 226S (4) and one of the following: HIST 111 (4) HIST 112 (4) HIST 113 (4) GEOG 125 (4) PSYC 101 (4) SOCI 101 (4) ECON 101 (4) GOVT 101 (4)	12 ANTH 101 (4) ANTH 250 (4) ECON 102 (4) GOVT 102 (4) GOVT 120 (4) GOVT 250 (4) HIST 201 (4) HIST 202 (4) HIST 203 (4) PSYC 151 (4) PSYC 273 (4) SOCI 201 (4) SOCI 205 (4)	HIST/ENGL 227S (4)
Natural Science minimum 9 qtr./6 sem.	Select 12 hours from BIOL 110S (4) or PSCI 110S (4) and one or two of the following: CHEM 121 ¹ (4) CHEM 122 ¹ (4) CHEM 141 ¹ (4) CHEM 142 ¹ (4) CHEM 143 (4) All CHEM — 3 lec./3 lab PHYS 201 (4) PHYS 202 (4) PHYS 203 (4) All PHYS — 3 lec./3 lab BIOL 151 (5) 3 lec./4 lab GEOL 101 (4) 3 lec./2 lab	9 - 12 BIOL 162 (5) BIOL 170 (4) BIOL 202 (5) BIOL 203 (6) CHEM 200 (4) CHEM 201 (4) GEOL 112 (4) PHYS 210 (4)	BIOL 110S (4) or PSCI 110S (4)
			Other 485S (2) ² 490S (4) ²
Subtotal minimum 36 qtr./24 sem.	45-48	8 - 11	
Total	56		

54 - 60 quarter hours

¹ Students cannot receive credit for both the CHEM 121/122 and the CHEM 141/142 series.
² Prefix varies according to student's major: BADM, ENGL, ETCS, NTSC, or SOCI.

Appeal Procedure Regarding Transfer Credit Applicability

Historical Context. On November 16, 1990, the Ohio Board of Regents passed a resolution mandating that public institutions of higher education establish a multilevel appeal procedure to be followed by students dissatisfied with the applicability of transferred credit. The following multilevel appeal procedure at Shawnee State University is designed to meet the needs of these students and to comply with the Ohio Board of Regents' mandate.

Acceptance of Transfer Credit. Transfer credit is awarded and posted to the student's Shawnee State University transcript in accordance with accepted national and state standards. Generally, all courses satisfactorily completed at regionally accredited institutions are transferable. The Office of Transfer Placement is responsible for posting this credit to the student's transcript.

Applicability of Transfer Credit. After transfer credit has been posted to a student's transcript, the Office of Transfer Placement provides the dean of the college in which the student is enrolled with a packet of material enabling the dean and appropriate faculty to determine how transfer courses apply to the student's graduation requirements. Once this applicability has been determined, the Office of Transfer Placement posts the courses to the student's Degree Audit and provides the student with a copy of the audit.

Multilevel Appeals Procedure. State mandate requires that a student be notified of his/her right to appeal a transfer credit applicability decision. The student must file the written appeal within ninety days following receipt of the Degree Audit. The University must respond to the appeal within thirty days of receipt of the appeal, at each appeal level. The appeal levels are defined below.

Level 1

The student meets with the dean of the college in which he/she is enrolled to discuss the course(s) in question. If both dean and student are in agreement that a change in applicability is desirable, the dean reports the necessary change with rationale to the director of transfer placement. If the dean determines that an applicability change is not warranted, the dean notifies the student, the Transfer Credit Appeals Committee chair, and the provost regarding the decision and the rationale.

Level 2

If the student and the dean are unable to reach a mutually agreeable resolution, the student presents his/her case before the Transfer Credit Appeals Committee. The Transfer Credit Appeals Committee is charged with reviewing the manner in which transfer credit has been applied to a student's degree program when the student and the appropriate dean are unable to reach a mutually satisfactory agreement. The committee may vote to support the dean's position, the student's position, or suggest alternatives for the dean and the student to consider. This committee reports to the provost and is composed as follows:

- One faculty representative from each of the following colleges
 - Business
 - Engineering Technologies
 - Health Sciences
 - Center for Teacher Education
- One faculty representative from each department within the College of Arts and Sciences
 - Arts and Humanities
 - Mathematics
 - Natural Sciences
 - Social Sciences
- The director of transfer placement and the core coordinator serve as voting *ex officio* members of the committee.

If the committee determines that a change in applicability is desirable, the committee chair reports the necessary change with rationale to the student, the dean, and the director of transfer placement. If the committee determines that an applicability change is not warranted, the committee chair notifies the student, the dean, and the provost regarding the decision and the rationale.

Level 3

If the student and the Transfer Credit Appeals Committee are unable to reach a mutually agreeable resolution, the student presents his/her case to the provost. If the provost determines that a change in applicability is desirable, he/she reports the necessary change with rationale to the student, the dean, the Transfer Credit Appeals Committee chair, and the director of transfer placement. If the provost determines that a change in applicability is not warranted, the provost notifies the student, the dean, and the Transfer Credit Appeals Committee chair of the decision and the rationale. The student has no further recourse within the institution. However, if the student wishes to pursue the matter further, a statewide appeals procedure is available.

Transfer Credit Appeals Committee Membership. Faculty representatives to the Transfer Credit Appeals Committee will be determined by a procedure agreed upon by the faculty within their respective units as indicated in Level 2. Committee members will annually elect a chair. The committee chair will vote only in the event of a tie. Staggered terms of three years will begin January 1. Elected representatives may be required to meet during the summer months if a student submits an appeal during that time period. Deans may appoint alternates if necessary. The director of transfer placement and the core coordinator serve as voting *ex officio* committee members.

International Students

International students who are seeking admission to Shawnee State University must submit the following materials:

- An application for admission accompanied by the current application fee.
- All official secondary and postsecondary transcripts. These transcripts must be in the student's native language and be accompanied by a certified English translation. If these credentials cannot be evaluated by the University, they will be sent to an evaluation service, and the student will be responsible for the cost of the evaluation.
- An official score of 500, at a minimum, on the Test of English as a Foreign Language (TOEFL), or an equivalent score on the Michigan Test of English Language Proficiency (MTELP) is required for admission to a degree program for students whose native language is **not** English.
- Proof of financial resources which are adequate to support the student for one year. Applicants who intend to finance their education themselves must supply a statement from their bank showing funds equal to those required for one year. For applicants who are being sponsored, an affidavit of support and a bank statement showing adequate funds for one year must be submitted. In addition, **all** international students are required to submit a deposit equal to one thousand U.S. dollars (\$1,000.00)¹ prior to the issuing of an I-20. This deposit is held by the University and will be returned **only** when the student (1) graduates from Shawnee State, (2) transfers to another college/university, or (3) withdraws from Shawnee State. The student must petition the business office, on the required form, for the return of his/her deposit.

¹ Shawnee State University reserves the right to request full payment in advance.

This deposit will be returned **only** for the three reasons stated on the previous page and only after all financial obligations to the University have been met by the student.

International students are required to accept the cost of university health insurance or produce proof of adequate insurance while in the United States.

Those international applicants who are accepted for admission will receive an acceptance letter and an I-20 form to be used to secure a student visa. The acceptance letter and I-20 will not be issued until the Office of Admission has received all required materials. To be assured consideration for admission, all required materials must be received 60 days prior to the beginning of the quarter in which the applicant plans to enroll.

Questions pertaining to a student visa should be directed to the local office of the Department of Immigration.

Non-Degree Students

Special Non-Degree Students

Students who are not interested in pursuing a degree but who wish to take courses are required to file an application for admission with the current application fee. Transcripts of high school and college work are not required, nor is ACT/SAT testing. However, if at a later time, the non-degree student decides to pursue a degree program, all admission requirements in effect **at the time of initial enrollment** must be met. These requirements include official transcripts from high school (and/or GED) and college work and testing, recommendations, etc., if any of these are required for the major being declared.

Students enrolled in the GED program are special, non-degree students and, as such, are not required to take the ACT. If, after completion of the GED, a student wishes to pursue a degree, the student will be subject to requirements for admission of a degree applicant.

Special, non-degree students may take courses which have no prerequisites or courses for which the student has the appropriate prerequisite. For courses assuming prior knowledge or a certain degree of proficiency, placement testing may be advised or required prior to registration.

Transient Students

Students who are enrolled at or seeking a degree at another college or university, but who wish to take coursework temporarily at Shawnee State University, are considered transient students. As non-degree students (at Shawnee State), said students are required only to file an application for admission with the current application fee.

Although transcripts of high school and college work are not required of transient students, such transcripts, especially those from the individual's home campus, are helpful in advising appropriate coursework. Unofficial transcripts or grade cards are acceptable if these are needed to verify prerequisites for courses to be taken at Shawnee State University.

Transient students are strongly advised to consult with the appropriate counselor or advisor at the home college or university as to the appropriate coursework to be taken at Shawnee State and how that coursework will transfer to the home campus of the transient student.

In the event a transient student decides to seek a degree at Shawnee State University, he or she becomes a "transfer student" and is bound to all requirements for a degree-seeking (transfer) student, including whatever requirements existed for the major to be pursued at Shawnee State at the time of initial enrollment.

Services.
Fees. and
Facilities

Senior Citizens

Shawnee State University admits senior citizens (60 years of age or older) for courses, on an audit, space-available basis. Although formal application and registration are required, no tuition fees are charged. Lab fees are charged when applicable. Senior citizens who wish to take courses for credit are charged the usual tuition and fees.

There is also a special, no cost, fitness program for seniors. Applications may be obtained at the Shawnee State University Sports Center.

Academically Advanced High School Students

Junior and Senior Students

The Postsecondary Enrollment Options Program offers academically talented high school juniors and seniors the opportunity to take, in a college setting, courses which enhance coursework available at their high schools and which are clearly at the collegiate level.

Because the courses taken under this option are at the collegiate level, it should be expected that these courses are more demanding and completed at a faster pace than those taken in high school. They generally require more out-of-class preparation than high school classes. Students and their parents should also consider the emotional and social maturity necessary to study in an adult environment in which most students are in their late teens/early twenties and assess the student's ability to accept independence and responsibility for their academic performance.

Eligibility

To be eligible for the Postsecondary Enrollment Options Program, students must:

- Be a resident of the state of Ohio.
- Have completed at least the sophomore year of high school and be of junior status, as defined by the school district.
- Be commuting from their permanent residence and attending a high school within commuting distance.
- Have unscheduled time available in their high school day (not counting lunch period). S.B. 140 allows only as many college courses as students have free periods in their high school day.
- Provide evidence of a high school GPA of 3.0 on a 4.0 scale. (The 3.0 GPA is not required for summer quarter attendance by high school students.)
- Take a placement test and place at a collegiate level in reading, English, and mathematics (i.e., 100 level or above).
- Maintain a cumulative GPA of 2.0 (C average) for coursework at Shawnee State, and a 3.0 cumulative GPA (including transferred Shawnee State coursework) at the high school.
- Submit the application for admission, current application fee, official high school transcript, and copy of the completed acknowledgement form from the high school to the Office of Admission by the May 15 deadline. Placement testing must also be completed by this deadline.

Under this program, qualified students have two options:

Option A (college credit only)

- Student must take placement tests and place at collegiate levels.
- Student/parents/guardian pay for tuition, fees, books, and materials.

Option B (high school credit only)

- Student must take placement tests and place at collegiate levels.
- Students choosing this option should seek counseling from high school personnel as to which college courses will meet graduation requirements at their school.

- Tuition, fees, books, and materials are paid for by the state, based on an established formula. **Note:** If a student withdraws prior to the end of the quarter, any and all fees become the responsibility of the student and the student's parent(s) or guardian(s).
- Successfully completed courses under Option B receive appropriate high school credit as determined by the student's school district. The college credits earned at Shawnee State University as a high school student may be applied toward a Shawnee State degree or transferred to another university according to the transfer policies of the receiving institution.
- Courses may be taken under Option B during fall, winter, and spring quarters only. However, students may take courses during all four quarters, including summer, under Option A.

Note: Any Ohio high school junior or senior who wishes to attend Shawnee State University while enrolled in high school must do so under the Postsecondary Enrollment Options Program and meet all requirements of that program. Those who choose to pay tuition do so under Option A.

Application

Students must complete the PSEO application for admission and submit it with the current application fee (non-refundable) to their high school counselor. The counselor should then send, to the Office of Admission, the application, fee, and a copy of the acknowledgement form used by the high school when advising students and parents of the advantages, risks, and responsibilities involved in participation in the program. The acknowledgement form must bear the signatures of the applicant, parent(s), and high school official. To participate in the Postsecondary Enrollment Options Program at any time during a student's junior or senior academic year, the student must meet all requirements and apply by the May 15 deadline in the previous academic year. Students are not admitted after the May 15 deadline.

- The counselor must attach a current high school transcript to the completed application and acknowledgement form and forward them with the application fee to the Office of Admission. **A current transcript is required for each quarter of enrollment.** The acknowledgement form need be submitted only once, at the time of application.
- Deadlines for updated transcript and verification forms are:

Fall Quarter	June 15 ¹
Winter Quarter	November 15
Spring Quarter	March 15

Registration

- A required day of Orientation/Registration is held in August, at which time advisors assist students with course selection/registration. Registration is on a space-available basis, and classes are subject to cancellation.
- Students admitted to this program are permitted to register for most courses numbered at the 100 or 200 level, provided necessary prerequisites are met. Courses required for high school graduation (English, American History, and Government) may not be taken under the PSEO Program.
- PSEO participants may take a maximum of 12 quarter hours per quarter (minimum full-time), provided they have a sufficient number of free periods per day at the high school, not counting lunch period. A provision of S.B. 140 requires one free period per day at the high school for each college class taken.

¹ Only the transcript for the academic year is due on this date. All other required materials are due on May 15.

- PSEO participants may not take courses which are available to them at their high schools. The program is intended to enhance, not replace, courses offered at the local school.
- Students must attempt the courses as regularly graded courses. No grading options except A-F are available to students enrolled in this program.

Program Continuation

Students participating in the Postsecondary Enrollment Options Program are required to maintain a cumulative grade point average (GPA) of at least 2.0 for all college courses completed. Students whose cumulative GPA falls below 2.0 are not permitted to continue in the Postsecondary Enrollment Options Program. Further, the student must remain in academic and disciplinary "good standing" at the University and the local high school to remain eligible for this program. **Note:** Shawnee State University will honor any disciplinary action taken by the high school affecting a student in the Postsecondary Enrollment Options Program.

Acceptance, Notification, and Reporting

- In compliance with the law, ten days after completion of the application process, the following individuals are notified regarding admission status: the student, the student's parents (or guardian), the high school counselor, the district superintendent, and the state superintendent.
- Students are notified immediately of their enrollment.

Validation of Credit

- Grades are reported to the student and/or the student's parent(s) or guardian as appropriate.
- For students who have chosen to have courses used to complete high school requirements, the University will supply an official transcript of grades to the student's high school principal/counselor.

Freshmen and Sophomore Students

Freshmen and sophomore students in high school may enroll under the following requirements:

- Courses are to be taken for college credit only.
- Tuition, book, and fees are the responsibility of the student/parent(s)/guardian.
- Students may attend only one course per quarter.
- The student must show evidence of a 3.0 (A=4.0) grade point average (GPA) in local high school.¹ (The 3.0 GPA is not required for summer quarter attendance by high school students.)
- The student must apply for admission, submitting the high school application for admission and the non-refundable application fee, and provide a written recommendation by the high school counselor or principal along with written permission from parent(s)/guardian.
- School and parent/guardian recommendation and permission forms must be submitted each quarter of enrollment.
- Course schedule must be approved by the Office of Admission.

Orientation

Student orientation is required of every degree-seeking student entering Shawnee State University. The orientation process includes assessment in mathematics, English, and reading with subsequent placement into the appropriate initial courses

¹ The Office of Continuing Education may offer special programming which is exempt from the 3.0 GPA requirement.

in mathematics and English. No student may register for a mathematics or English class without having completed this assessment.

Additionally, students are advised as to their initial quarter classes, registered for those classes, given a tour of the campus, and provided with information concerning services available and academic rules and regulations.

Student orientation is scheduled well in advance of each quarter, with additional dates to accommodate late registrants. For more information, please contact the Office of the Registrar.

Student Academic Assessment Services

All first-time, entering, degree-seeking students must participate in the University's academic assessment and placement program prior to registering for English and mathematics courses. Students entering the University with credits from other colleges or universities must participate in the English placement testing process if they lack transferable English credits. All students must participate in the mathematics placement testing; however, transferable mathematics credits will be accepted.

The academic assessment program directs students into the university curriculum to ensure that entering students register for courses that match their level of academic preparedness for college-level coursework. Testing is mandatory, and placement is determined by test scores and other factors. These factors are determined by the appropriate division and may include ACT scores and high school background information. Upon being admitted to the University and as part of the admission packet, students receive information about how to schedule an appointment for academic assessment.

Throughout the course of their academic career at the University, students participate in a variety of assessment activities that assist the University in the development and enhancement of programming efforts.

Registration

New students for fall quarter must register for their initial quarter during the New Student Orientation held each July. (See "Orientation," beginning on page 26.)

Continuing or returning students may register for subsequent quarters during Advance Registration, Early Registration, and Late Registration. (Dates and times are found in the Academic Calendar, beginning on page 10.) Degree-seeking students are required to obtain advisor approval of their schedule before submitting their registration form.

"Preferential Registration" is available during the Advance Registration period for currently enrolled sophomores in associate degree programs and seniors in bachelor degree programs. Only the above students may submit registration forms during the Preferential Registration time period (see the quarterly Course Schedule for applicable dates).

Improper Registration

Admission or registration may be canceled by the director of admission or the registrar in cases of improper registration or when false or incomplete information is provided on the application for admission, registration forms, or other official documents. In such cases, the student will be notified in writing as to the action that was taken and the reasons for such action.

Selective Service Registration

Ohio law requires male students between the ages of 18 and 26 to be registered with the Selective Service System, unless they are on active duty with the armed

forces of the United States (other than the National Guard or reserves) or legally excluded, to be eligible for state educational assistance programs. Residents who are not registered or have not indicated they do not need to register by the first day of the quarter are required to pay the Out-of-State Tuition as required by Ohio law. Students can register with Selective Service in the year they become 18 and must complete registration by 30 days after their 18th birthday. Selective Service registration can be accomplished in a few minutes at any U.S. Post Office. Students wishing to indicate exempt status can request materials to do so by contacting the Office of the Registrar.

Residency Information

A nonresident surcharge is assessed to any student who does not qualify as a resident for subsidy and tuition surcharge purposes, in addition to other university fees. The following persons will be treated as residents of Ohio and will be assessed in-state fees:

1. A student who is dependent upon at least one parent or legal guardian who has been an Ohio resident for the 12 months preceding enrollment.
2. A person who has been a resident of Ohio for the 12 months preceding his or her enrollment and during this time has not received financial support from outside the state.
3. A dependent child of a parent or legal guardian, or the spouse of a person, who as of the first day of a term of enrollment, has accepted full-time employment and established a domicile in Ohio for other reasons than gaining the benefit of favorable tuition rates.

Other students may qualify if they are self-supporting while in Ohio pursuing a part-time course of study (conditional residents), are stationed in Ohio while on active duty in the military or have been Ohio residents while involved in active duty military service prior to enrollment, have worked as a migrant in Ohio, or have been requested to be out of the country by their employer. Some dependents of these persons may qualify as well.

Proof of residency may be presented in a Request for Resident Classification to the Office of the Registrar. This form and all documentation must be submitted by the following deadline dates in order to be effective for the desired quarter:

May 1 for Summer Quarter
August 1 for Fall Quarter
November 1 for Winter Quarter
February 1 for Spring Quarter

Retroactive residency determinations cannot be made for tuition surcharge purposes.

For information on residency, conditional residency, Selective Service requirements, or to receive a Request for Resident Classification, write or visit the Office of the Registrar.

Fees and Expenses

Registration fees are payable at the Bursar's Office prior to the opening of classes and in accordance with instructions issued with your quarterly bill. For students registering during late registration, fees are assessed as part of the registration process and are due at that time. Fees may be paid by cash, check, money order, Visa, or MasterCard. It is important that the student retain all fee receipts.

Payment of fees owed is a prerequisite to official enrollment, and all students should have sufficient funds (cash and/or financial aid) to cover expenses. A review of students enrolled will be made the 14th day of each quarter, and any student showing a balance due will be administratively dismissed.

Student Load

Students scheduled for 12-18 credit hours are considered full-time students. Students scheduled for fewer than 12 credit hours are considered part-time students. The permission of the registrar is required for students scheduling over 18 hours of credit. Please refer to the fee schedule for the rate per credit hour.

Certain students are restricted from carrying a course load greater than twelve hours. These students include first-time entering freshmen placed into two or more developmental education courses and any student placed on academic probation for a second consecutive quarter. A student affected by this policy may appeal to the director of developmental education. In special cases, when this policy would jeopardize a student's participation in a degree program, a department chair or chairperson may also request to waive the twelve-hour limit.

Student Fees¹

Full-Time Students

Quarterly Instructional Fee	\$727.00
Quarterly General Fee	126.00
Quarterly Out-of-State Fee	576.00
Quarterly Out-of-State District Fee	234.00

(Mason, Lewis, Boyd, and Greenup Counties, Kentucky and Cabel and Wayne Counties, West Virginia)

Special Note: All out-of-state students newly enrolled in health science programs for the 1993 fall quarter and beyond will pay the quarterly out-of-state fee rather than the quarterly out-of-state district fee.

Part-Time Students

Quarterly Instructional Fee	\$61.00/cr. hr.
Quarterly General Fee	11.00/cr. hr.
Quarterly Out-of-State Fee	48.00/cr. hr.
Quarterly Out-of-State District Fee	20.00/cr. hr.

(Mason, Lewis, Boyd, and Greenup Counties, Kentucky and Cabel and Wayne Counties, West Virginia)

Special Fees

Application	\$ 30.00
Late Registration	25.00
Late Payment	(fee per hour) 7.00
Late Installment Fee	20.00
Budget Payment Plan	30.00
Transcript	3.00
Transcript Immediate Action	10.00
Graduation	40.00
Graduation Reapplication Fee	5.00
Credit by Exam	40.00
Credit by Arrangement	(fee per hour) 76.00
Change Orders	(fee per change) 4.00
Health Science Fee	74.00
Education Clinical Fee	125.00
Evaluation of Credentials	50.00
International Student Orientation	200.00
Reenrollment Application Fee	30.00
Lab Fees	see next page
Parking Fee	see next page

¹ The student fees listed here are 1993-94 fees and are subject to change. Shawnee State University reserves the right to make, without prior notice, any fee adjustments that may become necessary.

Lab Fees

The current schedule of lab fees is available in the Office of the Registrar.

Parking Fee

The University is expected to initiate both a parking fee and a parking system in 1993-94. The proceeds from the parking fee will be used to improve and manage parking facilities on campus.

Budget Payment Plan

Shawnee State University provides a student Budget Payment Plan that assists students with the payment of tuition, books, and certain fees.

Information about the Budget Payment Plan is available in the Bursar's Office, located in room 108 of the Business Annex.

Bad Check Policy

Payment of fees owed is a prerequisite to official enrollment, and all students should have sufficient funds (cash and/or financial aid) to cover these expenses.

A check returned for insufficient funds is a federal offense and constitutes non-payment of your obligation to Shawnee State University. Therefore, any student who has a check returned for insufficient funds, and the same is not cleared by the 14th day of the quarter, shall be considered in noncompliance with institutional policy and will be administratively dismissed.

Any student administratively dismissed due to a bad check has no recourse for readmission for the current quarter.

Student Insurance

Shawnee State University makes available to all students the benefit of a comprehensive health insurance policy. Students may pick up a Student Insurance Program Brochure at the Bursar's Office. Questions concerning student health insurance should be referred to the Bursar's Office.

Refund of Fees

Continuing students dropping hours by change order through the 14th day of the quarter, when such changes result in a reduction of fees, are entitled to receive a 100 percent refund of the reduction. Changes made after the 14th day of the quarter result in no refund.

Students who officially withdraw from Shawnee State receive a refund, if due, based upon the following schedule. Students who do not officially withdraw are not eligible for any refund, and fees assessed are due and payable.

Time of Withdrawal

Regular Term

Prior to first day of classes 100% of Tuition
1 to 14 calendar days 80% of Instructional Fee
Over 14 calendar days No refund

Summer and Five-Week Session

Prior to first day of classes 100% of Tuition
1 to 5 calendar days 60% of Instructional Fee
Over 5 calendar days No refund

Please Note: This refund schedule applies to students registered only in a five-week session. Students taking classes from both a regular quarter and a five-week session are issued refunds under the regular term policy. Questions concerning the above information should be referred to the Bursar's Office.

Late Registration and Late Payment Policy

A late registration fee of \$25¹ is assessed all students enrolled in the previous quarter who do not register during the announced early registration period.

A late payment fee is normally not applicable since payment is a prerequisite to registration. However, should exceptions be made to the Registration Fee section, a late payment of \$7.00¹ per credit hour (maximum \$84.00) is assessed by the Bursar's Office.

Miscellaneous Fees

Application Fee

A \$30¹ non-refundable application fee must accompany all admission applications.

Transcript Fee

The University will produce an official transcript upon written request from the student at a cost of \$3¹ per copy. Unofficial transcripts, copies of schedules, etc. are available at a charge of \$1¹ per copy. Same day requests for transcripts are processed at a cost of \$10¹ to the student.

Change Order Fee

A fee of \$4¹ is assessed for each course change (add/drop) processed.

Graduation Fee

A \$40¹ graduation fee is required. Students are not billed for this fee. It is the student's responsibility to pay this at the time of submitting the petition to graduate. Student eligibility to graduate is determined by the registrar after the student petitions for graduation.

Financial Aid

An extensive financial aid program is available to assist students in meeting some of the expenses of a college education. The financial aid program is administered by the Financial Aid Office and includes four categories: scholarships, grants, loans, and employment.

Application Procedure

To apply for need-based assistance at Shawnee State University, all aid applicants (new and continuing students) must complete and submit the Free Application for Federal Student Aid (FAFSA) form to the federal processor. Need-based aid consists of the Pell Grant, Supplemental Educational Opportunity Grant, College Work Study, and Stafford Student Loan. Forms may be obtained from high school counselors or the Financial Aid Office at Shawnee State. All transfer students must submit a financial aid transcript from each school previously attended. **Financial Aid Deadline: A student's financial aid file must be complete 10 working days prior to the start of any quarter in which the aid is to be used.**

Federal regulations and/or institutional policies are subject to change without prior notice. The Financial Aid Office attempts to keep students updated through various media on campus and via written notices. Therefore, it is very important that all aid applicants update permanent and local addresses with the Office of the Registrar as necessary. Failure to keep the University updated to address, name, and other changes can seriously delay an award or be very costly to the student.

¹ This is a 1993-94 fee and is subject to change.

Determining Need

The Financial Aid Office uses the Free Application for Federal Student Aid form to establish what portion of the student's cost can be contributed by the student and/or parents (dependent students only), and need is determined as follows:

- Cost of Education (Budget)
- (-) Expected Family Contribution
- (=) Financial Need

Notification of Aid Offers

After the FAFSA needs analysis and other documents have been received and reviewed for accuracy (verified if applicable), written notification of award offer is sent to eligible applicants. Applicants who are denied scholarships or grants are encouraged to continue in the process to be considered for supplemental forms of assistance such as loans or employment.

Award Disbursements

A student must be officially enrolled through the Office of the Registrar to receive any type of financial assistance. All verification requirements for the FAFSA must be complete before financial aid can be disbursed. Disbursement dates and procedures vary depending on the type of assistance. Generally, financial aid awards are credited toward the student's account each quarter. Total financial aid awards greater than university charges are refunded, in the form of overage checks, beginning five weeks after the quarter starts.

Scholarships

The Financial Aid Office administers a number of special scholarships for students demonstrating a high degree of academic ability or special talents. Students interested in scholarships should contact the Financial Aid Office.

Grants

Federal Pell Grant. The Pell Grant is an entitlement program from the federal government. This means that all undergraduate aid applicants who establish eligibility receive funds based on their eligibility index, enrollment status, and the cost of education. The Pell Grant serves as a foundation for which all other aid is awarded. Interested students apply for the Pell Grant by completing the FAFSA as soon as applications are available in early January.

Federal Supplemental Educational Opportunity Grant (SEOG). The SEOG is a federal grant awarded to undergraduate students on the basis of exceptional financial need beyond the Pell Grant. These funds are limited to the amount allocated to the University by the U.S. Department of Education. Therefore, the most needy students are awarded these monies on a first-come, first-serve basis. Application for this grant is made through the completion of the FAFSA.

Ohio Instructional Grant (OIG). The OIG is a state-funded grant made available to eligible Ohio residents for meeting the cost of education. All Ohio residents who wish to be considered must complete and submit the OIG application to the Ohio Board of Regents. Students awarded this grant must carry at least 12 credit hours per quarter.

Please Note: Under the OIG program, a student must be enrolled in an eligible associate or bachelor degree program. Some remedial courses (listed as "099" in this catalog) do not count toward the 12 credit hour requirement. Contact the Financial Aid Office for further clarification.

Student Loans

Federal Subsidized Stafford Student Loan (Formerly GSL). The Subsidized Stafford Loan is a federal loan for undergraduate students enrolled at least half-time in an eligible institution. **This program requires that the applicant complete the FAFSA before making application for this loan.** Eligibility is based upon financial need and is calculated as follows:

- Cost of Education (Budget)
- (-) Financial Aid Awarded
- (-) Expected Family Contribution
- (=) Total Available for Stafford Loan

The Federal Subsidized Stafford Loan program is limited to \$2,625 for the freshman year, \$3,500 for the sophomore year, and \$5,500 per year for the junior and senior years. Under this loan program, payment and interest don't begin until 6 months after the student has graduated or is attending less than half-time (6 hours). Interest rates are capped at 9%. Loan checks are made copayable to the University and student in three disbursements from your lender.

Federal Unsubsidized Stafford Loan. The Federal Unsubsidized Stafford Loan is an additional loan available to dependent or independent students. Students are required to apply for the Subsidized Stafford Loan before making application for this loan.

Federal Parent Loan for Undergraduate Students (PLUS). The Federal PLUS Loan is a supplemental loan for parents of dependent undergraduate students. The borrower must be the natural or adoptive parent; be a U.S. citizen, U.S. national, or eligible non-citizen; and not be in default on a student loan.

The Federal PLUS Loan must be used for educational expenses at the school the student is or will be attending. Repayment begins in 60 days at a predetermined interest rate (lower than prime) each academic year. The borrower is responsible for all interest from the day the loan is disbursed. Checks are sent in the same manner as described under the Federal Stafford Loan.

Federal Supplemental Loan for Students (FSLs). The FSLs is for independent students only. The terms and conditions are the same as the Federal PLUS Loan, and the checks are sent in the same manner as the Federal Stafford Loan.

Please Note: Loan applications can be obtained from a participating lender for all the above named loan programs. First-year, first-time borrowers cannot receive Federal Stafford or FSLs funds until successful completion of 30 days of their first quarter. Students that withdraw from the University are not eligible for their next quarter's loan check and must reapply if they wish to continue receiving student loan funds.

Student Loan Fund. The Financial Aid Office makes available to students, on a limited basis, short-term loans for direct or related educational expenses.

Employment

Federal College Work Study (FCWS). The FCWS program is available to students who can demonstrate financial need through the completion of the FAFSA. All possible attempts are made to place FCWS students in positions which coincide with their career interests or academic majors.

Students are paid the current minimum wage and, in most cases, work 10-20 hours per week. Students are paid based on the number of hours worked every two weeks with the regular university payroll. Funding for FCWS is limited, therefore money will be awarded on a first come, first serve basis. Students should check with the Financial Aid Office if interested in obtaining information about FCWS.

Student Employment. Regular student employment is made available to all university students, regardless of financial need, on the basis of current openings. Interested students should contact the Office of Counseling and Career Services for further details.

Veterans' Benefits

The programs at Shawnee State University are approved by the State Approving Agency for the education of veterans and their eligible dependents. Students interested in V.A. benefits should contact the Financial Aid Office.

Eligibility Requirements

All federal, state, and campus financial aid is based upon full-time enrollment (12 credit hours). In some cases, students can receive reduced awards based on enrollment status (three-fourth time or half-time).

All Ohio residents are required to provide the appropriate documentation for proof of residence to the Office of the Registrar.

Students who receive Title IV financial aid (Pell, Stafford and SLS Loans, SEOG, and CWS) must maintain satisfactory academic progress, as defined below, to remain an eligible aid recipient.

Satisfactory Academic Progress

For all federal aid recipients, there are three elements to the Satisfactory Academic Progress requirement that must be met. Students must (1) earn a degree or certificate in the maximum time frame, (2) maintain minimum grade point average (G.P.A.) in relation to the number of hours attempted (see table 1), and (3) complete a minimum of 86% of the hours attempted based on enrollment status (full-time, three-quarter time, or half-time) (see table 2).

Students' academic records are reviewed each academic year to assure that they are maintaining satisfactory academic progress. Any student not in good standing at the end of any academic year is placed on standards of progress. Students who fail to meet any of the requirements for satisfactory academic progress are ineligible to receive Title IV funding until satisfactory standards have been met. Each student has the right to appeal this action by addressing his/her concerns in writing to the Financial Aid Office within 30 days of receiving official notice of such action.

Grades of incomplete and withdrawal are used for computation of hours attempted but not hours completed.

Table 1

Credit Hours Attempted	Accumulative Grade Average
21-40	.75 or below
41-55	1.00 or below
56-65	1.25 or below
66-75	1.50 or below
76-85	1.75 or below
86 and above	1.90 or below

Table 2

Full-time: (18 quarters or six academic years maximum time frame to complete program)

1st academic year:	31 cr. hrs. completed	4th academic year:	124 cr. hrs. completed
2nd academic year:	62 cr. hrs. completed	5th academic year:	155 cr. hrs. completed
3rd academic year:	93 cr. hrs. completed	6th academic year:	186 cr. hrs. completed

Three-quarter time: (24 quarters or eight academic years maximum time frame to complete program)

1st academic year:	23 cr. hrs. completed	3rd academic year:	70 cr. hrs. completed
2nd academic year:	47 cr. hrs. completed	4th academic year:	93 cr. hrs. completed

(continued next page)

Three-quarter time (cont'd.):

5th academic year: 116 cr. hrs. completed	7th academic year: 163 cr. hrs. completed
6th academic year: 140 cr. hrs. completed	8th academic year: 186 cr. hrs. completed

Half-time: (36 quarters or twelve academic years maximum time frame to complete program)

1st academic year: 16 cr. hrs. completed	7th academic year: 109 cr. hrs. completed
2nd academic year: 31 cr. hrs. completed	8th academic year: 124 cr. hrs. completed
3rd academic year: 47 cr. hrs. completed	9th academic year: 140 cr. hrs. completed
4th academic year: 62 cr. hrs. completed	10th academic year: 155 cr. hrs. completed
5th academic year: 78 cr. hrs. completed	11th academic year: 171 cr. hrs. completed
6th academic year: 93 cr. hrs. completed	12th academic year: 186 cr. hrs. completed

Academic Policies and Information

Academic Integrity

Students at Shawnee State University are required to do their own work on all tests and assignments. Any form of cheating may result in the student's being withdrawn from a particular course or courses, as well as possible dismissal from the University. (See *Student Handbook*.)

Grading/Awarding of Credit

Final grades are mailed at the end of each quarter by the Office of the Registrar. Grades will not be issued orally.

Grade	Description	Quality Points
A	Excellent	4.00
A-	3.67
B+	3.33
B	Good	3.00
B-	2.67
C+	2.33
C	Average	2.00
C-	1.67
D+	1.33
D	Poor	1.00
D-	0.67
F	Failing	0.00
TC	Transfer Credit	0.00
KE	Credit by Exam	0.00
NC	No Credit	0.00
WD	Withdrawal	0.00
I	Incomplete	0.00
P	Pass	0.00
AP	Advanced Placement	0.00
AU	Audit	0.00
NR	No Report	0.00

A grade of "F" receives no credit. Students making this grade must repeat the course if credit is to be received.

Class Ranking

Student class ranking is determined by the student's cumulative credit hours earned and the student's degree program (please note the chart below). Non-degree seeking students do not possess class rank.

Degree Program	Class Rank	Cumulative Hours Earned
Associate	Freshman	0 - 44
Associate	Sophomore	45 - no upper limit

Class Ranking (cont'd.)

Degree Program	Class Rank	Cumulative Hours Earned
Baccalaureate	Freshman	0 - 44
Baccalaureate	Sophomore	45 - 89
Baccalaureate	Junior	90 - 134
Baccalaureate	Senior	135 - no upper limit

Incomplete Grades

Students unable to attend class for extended periods of time may contact the faculty member responsible for the class to request an incomplete grade. Incompletes must be converted to a grade 30 calendar days into the next quarter or they are recorded as "F's."

Administrative Hold (financial)

With the approval of the registrar, an administrative hold may be placed on the records or accounts of any student who fails to comply in a reasonable period of time with an obligation imposed under university rules or who has an overdue debt or fine. An administrative hold will cause certain services to be withheld, including, but not limited to: obtaining current quarter grades, registering or enrolling, being certified as eligible to obtain a degree or certificate, receiving a transcript, borrowing books or equipment, or being certified to be eligible to participate in athletics.

The unit originating an administrative hold on the records or accounts of any student shall notify the student in writing of the obligation that is overdue by providing another itemized billing or list of action requested, specifying when the administrative hold will become effective and indicating the name and the method of contacting an individual who can provide additional information.

Any disputes concerning the legitimacy of the hold or its processing will be resolved by the registrar.

Dean's List/President's List

Full-time students (12 or more hours per quarter) who achieve a 3.5 to 3.99 grade point ratio will be placed on the Dean's List for that quarter. Full-time students who achieve a 4.00 grade point ratio will be placed on the President's List for that quarter.

Pass/No-Credit Policy

The pass/no credit option is designed to permit students to take a select number of courses for which no traditional letter grade (of "A" through "F") will be recorded on his/her grade report and transcript. Students wishing to take a course on a pass/no-credit basis must complete the proper forms at the registrar's office within the first 14 calendar days of a regular quarter or the first 7 calendar days of a 5-week term. The student's decision to take a class on a pass/no-credit basis is **not** subject to change.

To be eligible for the pass/no-credit option, a student must have earned a cumulative G.P.A. of 2.0 or better. First quarter freshmen will be considered as having met the above requirement.

The pass/no-credit option is subject to the following restrictions:

- A student may complete up to 8 quarter hours to be counted toward an associate degree or 16 quarter hours to be counted toward a baccalaureate degree under this option.
- A student may take only one (1) course pass/no-credit per quarter.
- Applicability of courses taken pass/no-credit toward a student's major program of study is subject to departmental approval.

- To receive a grade of P (pass), a student must earn a grade of C- or better in the course. If a student does not receive a grade of C- or better, a grade of NC (no-credit) will be awarded.
- A grade will be turned in at the regular grade-processing time and will be converted to a P or NC on the transcript by the Office of the Registrar.

Credit by Examination

Students have the opportunity to fulfill requirements for selected courses offered at Shawnee State University by examination. Students interested in pursuing this educational option should first secure the advice of an advisor or program director as to its appropriateness for the student's program of study. Since all courses are not available on a "by examination" basis, the student should then contact the appropriate chairperson. The chairperson, after consultation with appropriate faculty, makes a determination as to the feasibility of the student's request.

A fee of \$40¹ is charged for Course Credit by Examination. Approved proficiency is recorded as "KE" on the student's transcript. Credit by examination is not included in the calculation of cumulative grade point ratio.

Students are not eligible to take a proficiency examination for a course in which they have been enrolled for 20 class days or more.

Credit given by examination does not apply toward the 30 hour residency requirement for graduation.

College Level Examination Program (CLEP)

Students may be awarded credit for College Level Examinations taken under the College Entrance Examination Board. Students taking the general examinations in English composition, mathematics, natural sciences, humanities, social sciences, and history with the recommended scores of the Commission on Educational Credit and Credentials of the American Council on Education (ACE) will be given "KE" credit for the first sequence course in the above areas.

Many subject examinations may be used to earn "KE" credit for courses in subject areas of the examinations. Students must achieve recommended ACE scores to receive credit.

Credit given through the College Level Examination Program does not apply toward the residency requirement for graduation.

Credit for Military Educational Experiences

Credit may be awarded for military educational experiences. *The Guide to the Evaluation of Educational Experiences in the Armed Forces*, published by the American Council on Education, is used to determine possible college credit eligibility. Credit awarded for military educational experiences does not apply toward the residency requirement for graduation. Further information is available from the Office of Transfer Placement.

Prerequisites

Most learning beyond basic skills is dependent upon mastery of some prior skill or subject content. As a result, many courses at the University require the satisfaction of prerequisites prior to course enrollment. Prerequisites may be met by successful completion of the prior courses listed or by placement, via testing, into the course.

The academic division/school may withdraw a student from a course for which prerequisites have not been satisfied.

¹ This is a 1993-94 fee and is subject to change.

Repeating Coursework

Courses may be repeated for credit if so identified in the course description located elsewhere in this catalog. Courses may also be repeated for other purposes (e.g., attempts to raise grade), but only the highest grade earned and the associated credit will be reflected in the student's GPA (grade point average). The lower course grade will be replaced by the symbol "R" indicating the course was repeated.

While most courses are eligible for repetition, the following transcript symbols cannot be removed by subsequent course repetition: WD, AP, P, KE, NC, AU, TC (please note Grading/Awarding of Credit section on page 35 of this catalog).

Changing Grades

Students questioning course grades must contact the faculty member responsible for the class.

Grade Point Ratio

Quality points for a course are determined by multiplying the total credit hours by the numerical equivalent of the letter grade received in the course. The formula for calculating grade point ratio is:

$$\frac{\text{Total Quality Points}}{\text{Total Hours Attempted}} = \text{Grade Point Ratio}$$

Academic Probation

Students achieving a grade point average of 1.5 or less for any quarter are placed on academic probation for the following quarter provided their cumulative grade average does not fall below that required to remain enrolled. (See the following academic dismissal section.)

Academic Dismissal

Students are academically dismissed when their cumulative grade average falls below the following:

Credit Hrs. Attempted	21-40	41-55	56-65	66-75	76-85	86 and above
Cumulative G.P.A.	0.75 or below	1.00 or below	1.25 or below	1.50 or below	1.75 or below	1.90 or below

Students academically dismissed are eligible to re-enroll after one quarter.

Academic dismissal may affect Title IV student financial aid funds. Please check the financial aid "Satisfactory Academic Progress" chart (on pages 34 and 35 of this catalog) for further information.

Non-Credit (Audit)

Students may elect to take a course for non-credit (audit) during the first 35 class days of a quarter (17 days of the 5-week summer sessions) by completing the proper forms in the Office of the Registrar.

Credit by Arrangement

Students have the opportunity to fulfill requirements for selected courses offered at Shawnee State University by arrangement. Students interested in pursuing this educational option should first secure the advice of their faculty advisor as to its appropriateness for the student's program of study. Since all courses are not available on a "by arrangement" basis, the student should then contact the appropriate dean, director, or chairperson. This individual, after consultation with appropriate faculty, makes a determination as to the feasibility of the student's request.

Students may earn up to 18 credit hours toward graduation with all credit being considered resident credit. The student is limited to eight hours of credit by arrangement per quarter. Students enrolling in a course by arrangement have until the date grades are due the following quarter to have all work completed in the course.

Credit hours attempted/earned via this option are not applicable towards full-time student status.

See fee schedule for course by arrangement fees.

Honors Program

The Shawnee State University Honors Program is designed for students with exceptional academic and creative abilities. The program, besides providing recognition to the bright and highly motivated, gives talented students the opportunity to interact with their peers and faculty in a challenging and supportive environment.

Functions. The Honors Program enriches student life in three ways:

Honors Classes. The Honors Program offers a small number of honors seminars, colloquia, sections of standard classes, and "directed readings" courses on the main campus. (With the consent of the instructor, these honors courses are also open to non-honors students.)

Honors Advisement. The Honors Program provides special, supplementary academic advisement on an *ex officio* basis. The advisement offers scheduling assistance and provides information on graduate and professional schools.

Other Activities. The Honors Program arranges, for its students, special activities that are both academic and social in nature.

Honors Program Admissions Policy. Membership of the Shawnee State University Honors Program represents approximately the top three percent of the full-time student population. Selection is based on a multi-dimensional rating scale, including (but not limited to) accumulative grade point average and ACT/SAT scores.

Requirements for Honors Students. Honors students graduating with a 3.75 accumulative grade point average (or better) who have completed a minimum of 24 credit hours of honors courses (12 credit hours in the case of a two-year degree) graduate with a special "Honors Program Certification." This certification is indicated on their academic transcripts.

Further information about the Honors Program may be obtained from the Office of the Provost, (614) 355-2472.

Internship Guidelines

Programs requiring internship as part of the graduation requirements have guidelines for internship established by faculty. Students are urged to request a copy of these guidelines from faculty advisors.

International Study Programs

The University encourages, promotes, and facilitates the development of intercultural and multicultural academic pursuits of students. Thus, to meet these ends and to provide students with opportunities to broaden their foreign study experiences, international awareness and exchange programs, as well as travel and language study abroad, are periodically sponsored by the University.

Shawnee State also takes great pride in the international faculty who teach at the University. These faculty, and the students we welcome from other countries, share their international perspectives every day and enrich the lives of everyone in the Shawnee State academic community.

International programs at Shawnee State may take many forms: summer courses taught by university faculty, courses at foreign educational institutions, field studies,

and student exchange programs. The University annually sponsors an International Awareness Week and periodically hosts Visiting Fulbright Scholars and lecturers. In order to increase the possibilities for students to benefit from a variety of international study options, Shawnee State University has also established a sister-institution agreement with Nizhny Novgorod State University in Russia, and others are being explored with universities in Japan, China, and England. Additional study opportunities may be available in cooperation with the city of Portsmouth, which is a sister city to Orizaba, Mexico and Zittau, Germany.

Many University-sponsored international programs and events are available to both students and community members. Others may require students to meet specific eligibility criteria. For example, participation in the exchange program with Nizhny Novgorod State University is open to all full-time students with at least a sophomore standing and a good academic record. Final approval for participation is granted by the provost upon recommendations by appropriate deans and the International Program Selection Committee.

Students interested in international exchange opportunities, including the program with Nizhny Novgorod State University, should plan early, consulting first with their faculty advisors and then with Dr. Hagop S. Pambookian, International Program Committee representative and professor of psychology.

Faculty Advising

Academic advising for degree seeking students is provided by faculty advisors. The purpose of faculty advisement is to assist students with their immediate academic concerns. Faculty members meet with students by appointment, and each faculty member has available hours posted near his or her office.

Faculty Expectations and Responsibilities

Faculty expect regular and punctual attendance at all classes. Attendance policy for individual classes is made by the faculty member responsible for the class. Grades are controlled by the faculty member responsible for the class.

In the event that a faculty member is not present at the normal time class begins, students are to remain in the classroom an additional 15 minutes. If the class meets once a week for 3 to 5 hours, students must remain in the classroom for 45 minutes. If the faculty member has not arrived or no special instructions have been received, students may leave class without penalty.

All faculty members post office hours during which they are available to discuss individual problems relating to students' academic progress. Students are encouraged to take full advantage of the advisors.

Visitors to Class

Students planning to bring a visitor to a class with them are requested to obtain permission of the faculty member responsible for the class in advance of the visit.

Bringing Children To or Leaving Children At the University

Children are welcome at the University, with you, at any family event. However, please do not bring children to the University and leave them unattended while you are in class or at another university related event. If you have a problem finding or paying a baby-sitter, please stop by the Office of Student Activities and pick up a copy of *A Day Care Center Resource Guide*, developed by the Student Senate for your information and assistance. In any case, the University cannot be responsible for children that are left unattended.

Adding a Class

Students may add a class to their schedule during the first five class days of the quarter (five days of a five-week summer session) by completing a change order in the Office of the Registrar. A fee is assessed for each change.

Withdrawing from a Class

Students may withdraw from a class through the 14th calendar day of the quarter by completing a change order form in the Office of the Registrar and paying the appropriate fees. During the first 14 calendar days, if class withdrawal affects fees, a refund is possible. Any withdrawal after the 14th calendar day results in a WD being placed on the student's academic record.

Students may withdraw from a class the 15th through 49th calendar days of the quarter by obtaining the signature of the instructor on a form obtained from the Office of the Registrar. Appropriate fees must be paid and the form returned to the Office of the Registrar.

In cases of emergencies, as determined by the Office of the Provost, students may withdraw from a class after the 49th calendar day, but no later than 5:00 p.m. on the final day of classes by obtaining permission from the Office of the Provost, paying appropriate fees, and completing appropriate forms. Faculty members are notified by the Office of the Provost of these emergency withdrawals.

Withdrawing from College

Students withdrawing from college when classes are in session must complete the proper forms in the Office of the Registrar. Grades for scheduled classes are recorded as withdrawals (WD). See fee schedule for refund policy.

Students not following the withdrawal procedure are considered enrolled in the class and are graded accordingly.

Transcripts/Grade Reports

Each quarter students receive a grade report that includes grades achieved that quarter. Students having errors in grade reports should contact the registrar within 30 days of receiving the grade report.

Students may request transcripts from the Office of the Registrar. Requests for official transcripts must be in writing and addressed to the Office of the Registrar. The transcript fee is \$3.¹

Graduation Requirements

In order to graduate, students must have successfully completed all course requirements and have achieved a 2.0 cumulative grade point ratio in all coursework *and* in their major field of study. Students having outstanding institutional bills or notes are not issued a degree. All students are required to earn a minimum 30 hours of credit for the associate degree and 45 hours for the baccalaureate at Shawnee State University in order to be eligible for graduation. Students must petition to graduate by the deadline published in the calendar. Petitions are available in the Office of the Registrar.

Please Note: Students in health science majors must be in good standing in order to graduate.

Graduation with Honors

Students who achieve a cumulative grade point ratio of 3.25-3.49 prior to the quarter of graduation are graduated cum laude. Students who have achieved a

¹ This is a 1993-94 fee and is subject to change.

cumulative grade point ratio of 3.50-3.74 prior to the quarter of graduation are graduated magna cum laude. Students who achieve a cumulative grade point ratio of 3.75 or above prior to the quarter of graduation are graduated summa cum laude.

Graduation/Persistence Rates

Student graduation/persistence rates are available in the Office of the Registrar and the Office of Admission.

Counseling

The University provides a variety of services through the different offices of Student Affairs. Admission, placement, financial aid, veterans, educational, and vocational counseling are available to students. Counseling sessions are confidential. A list of staff and their building locations follows. Office hours are posted.

Michael Bankey <i>admission</i>	University Center
Tom Charles <i>transfer placement</i>	University Center
Fred Chrisman <i>student activities</i>	University Center
Patricia Gilmore <i>disability services</i>	Business Annex
Steve Gregory <i>admission</i>	University Center
Dick Howard <i>counseling and career services</i>	Commons Building
Dr. Michael Hughes <i>counseling and assessment</i>	Commons Building
Sandra Lawyer <i>JOBS student retention program</i>	The Connection ¹
Eustace P. Matthews <i>student support and minority affairs</i>	University Center
Dr. Stephen Midkiff <i>registrar</i>	University Center
Brenda Miller <i>JOBS student retention program</i>	The Connection ¹
Rosemary Poston <i>admission</i>	University Center
Suzanne Shelpman <i>JOBS student retention program</i>	The Connection ¹
Dale Taylor <i>JOBS student retention program</i>	The Connection ¹
Deborah Watson <i>JOBS student retention program</i>	The Connection ¹
Eugene Wilson <i>financial aid/veterans</i>	University Center
Rick Vournazos <i>admission</i>	University Center

Office of Counseling and Career Services

The Office of Counseling and Career Services has a two-fold mission.

Counseling and Assessment

The mission of the Counseling and Assessment Center is to develop programs which meet the personal and developmental needs, while enhancing the growth, of the student. Typically, services are provided to students who are experiencing short-term, situational, or crisis-oriented personal concerns which interfere with their academic progress and/or personal development. These services are provided through individual, group, and couple counseling, as well as specialized programs such as the biofeedback unit. In addition, assessment and evaluation services are available, as well as specialized, structured group programs. The Center also offers referral services to other professionals and agencies in the community. All services are confidential.

The Center is located on the first floor of the Commons Building and can be accessed by walking in or calling the center's main number, (614) 355-2213; Dick Howard, (614) 355-2259; or Dr. Michael Hughes, (614) 355-2539. The Center's hours of operation are: Monday through Friday, 8:00 a.m. to 5:00 p.m., and evenings by appointment.

¹ 25 Union Street

Career Services

Career Services assists students as they deal with a number of career-related issues. Specifically the service will:

- Help undecided students select a major.
- Help currently enrolled students secure on- and off-campus employment.
- Help students develop job search, interviewing, resume, and cover letter writing skills they can use as they seek employment.
- Maintain a placement office which supplies students with job leads.
- Help students transfer to other four-year universities or to graduate and professional schools.

These services are available to students, staff, and alumni of the University at no charge. The office is located on the first floor of the Commons Building and may be reached at (614) 355-2259. The office is open Monday through Friday, 8:00 a.m. to 5:00 p.m., and selected evenings and other times by appointment.

Student Support Services

Student Support Services promotes the education and development of minority students, students with disabilities, and special needs students. The administrative office of Student Support Services is located in the University Center, room 241.

International Student Support Services

International Student Support Services offers a variety of support designed to enhance the personal and intellectual opportunities for international students. Programs and activities ease the international student's transition into campus life and include social and cultural opportunities which expose all students to cultural diversity as well as contribute to their educational development. The office is located in the University Center, room 241. Further information can be obtained by calling (614) 355-2276 or (614) 355-2442.

Office of Disability Services

The Office of Disability Services provides special support to all disabled students. An individual plan of support services is developed for each disabled student, particularly those who are identified as learning disabled.

All disabled students are urged to register with the Office of Disability Services and obtain information on the various types of assistance available. For a list of available services (i.e., handicapped parking privileges, disabled scholarships, sign language interpreters, tutorial help, use of special adaptive equipment) please request the *Because You're Able* brochure. The office is located in the Business Annex, Learning Center, or further information may be obtained by calling (614) 355-2456 or (614) 355-2442.

Office of Minority Affairs

The Office of Minority Affairs offers a wide variety of culturally supportive services and programs designed to enhance the personal and intellectual development of the minority student at Shawnee State University. Included are peer tutoring and mentoring programs, leadership training, community service, and social activities.

Information about minority scholarships, minority employment, educational opportunities, and more is available by contacting the coordinator. The office is located on the second floor of the University Center, room 241. The phone number is (614) 355-2276 or (614) 355-2442.

Office of Women's Programs

The G.R.O.W. (Generating Realistic Opportunities for Women) program offers a wide variety of support services to the reentering female student. Included are

Services.
Fees. and
Facilities

individual and peer counseling, a college mom's and women's group, minicourses and lectures on issues of interest to women, leadership training, and community service. The uppermost goal of the program is to help women successfully complete their degree objectives by focusing on the unique concerns of women students. The office is located in the University Center, room 241. For further information, call (614) 355-2370 or (614) 355-2442.

The Connection

The mission of the JOBS Student Retention Program is to assist ADC/JOBS recipients in becoming emotionally independent and academically successful students. This is accomplished by providing comprehensive case management which covers all socio, economic, and academic needs. All program components are designed to address individual barriers to entering and retaining students in a higher education environment. This includes both curricular and extra-curricular life. All issues which impact a student's ability to remain in their academic program are addressed and through a holistic counseling and guidance approach are attempted to be resolved.

The program consists of three major components: initial, ongoing, and individualized. Initial services are provided the quarter prior to actual Shawnee State University enrollment. Various groups are facilitated to prepare students for a higher education career. Currently enrolled students can then benefit from ongoing and individualized services such as purchase of course related needs (texts, uniforms, etc.) and summer school scholarships.

The Connection is located at 25 Union Street. Office hours are from 7:00 a.m. to 5:30 p.m., Monday through Friday, and the telephone number is (614) 353-6400.

Transfer/University Parallel Programs

Because curricula in various colleges and universities differ, students who plan to transfer to another baccalaureate institution should follow the procedures outlined below:

- Secure a catalog from the institution to which you wish to transfer, and become familiar with its admission requirements and suggested freshman and sophomore courses in your major field of interest.
- Confer with an admissions officer at the receiving institution for further information about transfer regulations and applicability of credit. If necessary, confer with individuals in the appropriate academic departments at the receiving institution.
- Consult with the director of transfer placement at Shawnee State about fulfilling requirements mandated by the receiving institution. The Office of Transfer Placement is located in the University Center.

Acceptance of credit from Shawnee State is at the discretion of the college or university to which the student is transferring. Students assume responsibility for course selections necessary to satisfy the requirements of the institution to which they intend to transfer.

Developmental Education

If students lack college-level academic skills in basic English, mathematics, and/or science, they may choose or be advised to take developmental courses in these areas. Furthermore, in instances where placement test outcomes indicate an explicit need for college preparatory coursework, students are required to take certain developmental courses before registering for some university courses.

Developmental courses provide underprepared students an opportunity to gain the skills and knowledge necessary to attempt college-level coursework. They are intended for students who have had no background in a subject (e.g., biology and physics), inadequate preparation in a subject (e.g., mathematics, writing, reading), or have been away from school and need review. Credit hours earned in developmental courses, excluding UNIV 101 and 102, cannot apply toward degree requirements.

The Department of Developmental Education offers the following courses. Their descriptions are found in the "Course Description" section of this catalog, beginning on page 157.

BIOL 099	Fundamental Biology
ENGL 095	Basic Writing 1: Mechanics
ENGL 097	Reading Development 1
ENGL 098	Reading Development 2
ENGL 099	Basic Writing 2: Paragraphs and Essays
MATH 099	Fundamental Mathematics
PHYS 099	Fundamental Physics
UNIV 101	Academic Development Skills
UNIV 102	Personal Development Skills

Learning Center

The Learning Center, located in the Business Annex, is best described as a help center. Students usually seek the assistance of the Center's personnel, programs, and equipment when they need extra help preparing for class. Toward meeting its goal of helping students prepare, the Center offers a variety of services to Shawnee State students.

One of the most popular Learning Center programs is the tutoring program. Students needing help understanding course concepts and completing course assignments may request the assistance of a peer tutor, another student who has proven competent in a subject and has volunteered to help other students taking a course in the subject.

The Learning Center provides many types of audio-visual instructional devices for use by individual students. These include slide projectors, videotape recorder/players, audiotape recorder/players, and filmstrip projectors. Also very popular with Shawnee State students are the microcomputers and instructional software available to them in the Center. These are used for programming and word processing.

Many of the University's learning assistance programs have their home in the Learning Center. These include developmental education, Student Academic Assessment Services, the GED Program, and Shawnee BASICS (Basic Adult Skills in a College Setting).

Athletics

Shawnee State University's philosophy holds that there is more to learning than academics. Besides attending classes, every student has an opportunity to participate in recreational or athletic activities. Athletics at Shawnee State University consist of intercollegiate, intramural, and individual sports activities.

Intercollegiate Athletics at Shawnee State University

The objective of intercollegiate athletics at Shawnee State University is to promote the education and development of student athletes through athletic participation. The athletic department shares the University's commitment to high

standards and embraces the concept of the student athlete. Educational development is the central focus of the department.

At Shawnee State University, we believe that a learning experience isn't confined to the classroom or laboratory, but is a combination of the student's total college experience. That's why our athletic program is viewed as a cocurricular activity and, as such, is considered an educational experience. Students are involved in our athletic programs as student athletes, student assistant coaches, statisticians, trainers, managers, cheerleaders, band members, and ushers. The goal of the Shawnee State Athletic Department is to insure that the intercollegiate athletic experience is one from which our students can learn and grow.

Athletic policies at Shawnee State conform to the National Association of Intercollegiate Athletics (NAIA). Presently, Shawnee State fields teams in men's and women's basketball; men's soccer, golf, and baseball; and women's volleyball, softball, and tennis. The University's intercollegiate athletic teams are affiliated with the Mid-Ohio Conference (MOC) and NAIA District 22.

Intramural Sports

Competitive sports and recreational activities are a desirable part of a student's educational program. Through participation, the individual develops an appreciation of the worthy use of leisure time and a wholesome attitude toward physical activity.

The Intramural Department conducts activities of interest to the men and women of Shawnee State University. The department's goal is to provide an opportunity for every individual to participate in some activity of his or her own choosing. Intramural activities are organized on a team and individual basis, thereby enabling all to participate. Ability is not the issue; the only requirement is a desire to participate.

Student Activities

The Office of Student Activities is located in the University Center, administrative office, room 103. Dedicated to the principle that there are many valuable experiences which should be provided for college students outside the academic area, the office encourages students to explore ideas and to implement programs which aid in student maturation. These activities help train students to become more knowledgeable citizens and thus better able to participate in our democratic society.

Student activities are a good way for students to meet new friends, develop new interests and skills, and participate in valuable leadership experiences.

Activities sponsored by the office include the Student Senate, the Student Programming Board, Greek organizations, the student newspaper, and a variety of student clubs and organizations.

Information concerning clubs and organizations is available in the Office of Student Activities. Students who desire information about an existing club or would like to start a new club may contact the director of student activities.

Student Life Transcript Program

The Student Life Transcript Program is an effort on the part of student affairs to recognize students for their involvement in activities while in attendance at Shawnee State University.

Forms are available in the student activities' office for students to list all of their activities. Students are asked to turn in the form along with the signature of their appropriate advisor for the activity in which they were involved.

A file which includes all reported activities is maintained in the Office of Student Activities. Upon graduation, a certified listing of all activities is presented to the student and/or mailed to prospective employers or other educational institutions. Students are encouraged to keep their activity file updated on a quarterly or yearly basis.

Pep Band

Shawnee State University sponsors a student pep band which plays at athletic contests and at selected events. Some pep band members are paid a small fee for participating in the band in addition to receiving college credit for this activity. Interested students should contact the Office of Student Activities for further information.

Identification Cards

Identification cards are issued to Shawnee State University students. An I.D. card is the means of identification necessary for using the Library and participation in student activities. Students must present evidence of registration certification at the time the I.D. card is received. Validation of the I.D. is required each quarter at registration.

Identification cards are available through the Office of the Registrar.

Bookstore

The Shawnee State University Bookstore is owned and operated by the University for the convenience of students, faculty, and staff. The main purpose of the Bookstore is to provide textbooks and supplies necessary to complete required coursework. In addition, items such as calculators, computer supplies, swimming and racquetball equipment, art and drafting supplies, gift items, and a wide selection of imprinted campus wear are available.

Library

The Shawnee State Library, which houses both library and media services, is one of the newest and most technologically advanced facilities on campus. In addition to traditional services, the Library also offers a 350-seat lecture hall, classrooms, group study rooms, media production facilities, audiovisual hardware, public access personal computers, and a Kurzweil station for the visually impaired.

BEARTRACK, the Library's computerized catalog, provides access to over 108,000 books and documents in the collection as well as to a variety of materials in audio, video, and computer formats. Additional computerized and print indexes give access to 1,000+ periodicals and to 200,000+ ERIC microfiche. The Library's participation in OHIOLINK allows Shawnee State students free and immediate access to approximately 22 million items held in state university libraries in Ohio; alternately, via OCLC, students have interlibrary loan access to 27 million items in Ohio, in the U.S., and around the world.

University Center

Shawnee State's University Center was dedicated in the spring of 1992 and is the hub of extracurricular activities at the University and a home away from home for our students. A variety of functions and services are provided at the center.

Services.
Fees. and
Facilities

Staff at the **Information Desk** in the main lobby offer a list of campus activities, take I.D.'s, guide guests and students to their destinations, provide a campus phone and lists of campus clubs and organizations, and in general, assist students with any problem they may encounter.

Dining facilities for the University are located in the University Center. Breakfast, lunch, and dinner are served, as well as a wide variety of a la carte items. Both a main dining area and a snack bar are provided for the convenience of diners. The cafeteria is open from 7:30 a.m. to 8:00 p.m., Monday through Thursday and 8:00 a.m. to 5:00 p.m. on Friday. Hours of operation on the weekend vary, depending upon demand. A banquet room/study room, located on the second floor, is used for workshops, conferences, meetings, and any activity where food is served.

Two **student lounges** are provided for student use while relaxing or studying. The Micklethwaite Lounge on the main floor has a disclavier player piano, and the second floor lounge has two TV rooms. The Micklethwaite Banquet Hall is on the second floor and may also be used by students.

A **game room** on the first floor has Ping-Pong, card, and pool tables; board games; a 70" screen TV; video games; and athletic equipment which can be checked out by currently enrolled students.

Offices for the University Center director, building manager, Student Senate, Student Programming Board, and other clubs and organizations are on the first floor. The Offices of the Registrar, Admission, Financial Aid, Student Support Services, and Transfer Placement are located on the second floor.

The building also has an **Any Time Money Machine** and a **copier** for the convenience of our students and staff.

The University Center's **hours of operation** vary and are posted on the front door.

Housing

Celeron Square offers the Shawnee State student quality living accommodations on campus. It features fully furnished three-level townhomes for students. Each unit is designed to house eight students comfortably. Every townhome has complete kitchen, laundry, dining, and living areas. Celeron Square is owned, managed, and developed by University Housing, an independent development company. Call (614) 353-5405, for more information. In addition, a list of off-campus housing opportunities is available from the housing coordinator at (614) 355-2217.

Continuing Education

Shawnee State University is committed to serving the educational needs of learners of all ages. Through the Office of Continuing Education, the doors of educational opportunity are open to more than 7,000 lifelong learners annually. An array of credit and non-credit instructional programs are geared to meet a wide range of interests, abilities, and objectives.

Continuing Education strives to meet the variety of educational needs of its public, both on and off campus. Continuing Education works with business, industry, social agencies, and organizations to develop quality programs to help individuals pursue career endeavors and satisfy professional training needs. Each year the interest of youth is broadened through sport camps and academic camps for the talented and gifted. In an effort to serve special interest groups, the Office of Continuing Education has actively pursued grants funding and developed programs for displaced workers, small business owners, economically disadvantaged youth, and senior citizens.

In addition, Continuing Education serves as the home for Emergency Care Educational Programs and the Center for Business and Industry. For further information about course schedules or program development, contact the Office of Continuing Education.

Mission of Continuing Education

Shawnee State University's Office of Continuing Education offers programs to meet the diversified needs of those individuals who comprise business, industry, government, education, community, and other segments of society. Recognizing the importance of knowledge, values, cultural enrichment, and self improvement, the Office of Continuing Education is committed to designing and promoting those activities which enhance personal and professional growth and development. Learning opportunities are also provided for those individuals who desire to participate in continuing professional education conference and course experiences.

Special Programs and Community Services

In addition to community service and enrichment classes for all ages, the Office of Continuing Education offers a multitude of residential and commuter experiences for specialized groups—from the academically advanced secondary school student to the elderly lifelong learner. For professionals, classes which meet Continuing Education Unit requirements are available.

Center for Business and Industry

The rapid changes in technology and the resulting reorganization that is taking place in business and industry today demands that companies upgrade the skills of their employees to meet the challenges of tomorrow.

The increased importance of human resources necessitates that Shawnee State University increase its responsiveness to non-traditional training and professional development needs and programs.

The Center for Business and Industry's programs include short-term and non-traditional credit courses, noncredit continuing education and professional development training packages, and assessment of specific training needs. The Center for Business and Industry is also responsible for general coordination of all activities of the University that impact business and industry, including the coordination of the Ohio Technology Transfer Organization (OTTO) program.

Emergency Care Educational Programs (EMT/Paramedic)

The paramedic program is designed to prepare persons who can provide life support at the scene of any emergency. The program includes both classroom and hospital experience. In addition to performing functions of an EMT-A, under the revised code of Ohio, the paramedic is further certified to perform the following life support or intensive care techniques: cardiac monitoring, defibrillation, intubation, and administration of appropriate drugs and intravenous fluids. These functions are performed in conjunction with a cooperating licensed medical doctor, doctor of osteopathic medicine and surgery, or a physician advisory board.

Accreditation

The EMT-A program has received full accreditation from the Ohio Department of Education, the organization responsible for certification of Ohio's EMT-A's (#052480).

The paramedic training program has received full accreditation by the Ohio Department of Education, the organization responsible for accreditation of paramedic training (#5-3-005).

Services.
Fees. and
Facilities



1993-1995
Shawnee State University

49

Levels of Training Offered

Emergency Medical Technician-Ambulance (EMTA): A 110-hour course of study which covers emergency treatment at the basic EMT level. Includes classroom, hospital, and emergency vehicle training. Qualifies the student to take the State of Ohio EMTA examination. Ten credit hours. Ohio Accreditation No. 052480. EMTP 110.

Advanced Emergency Medical Technician-Ambulance [Epinephrine] (AEMT-AE): 112 hours of training in addition to that of the EMTA. Includes classroom, laboratory, and hospital components. Instruction revolves around intravenous therapy, treatment of life-threatening allergic reactions, and use of adjuncts for airway control and shock treatment. Qualifies the student to sit for the National Registry of EMT's intermediate level examination. EMTP 210, 211, and 212.

Emergency Medical Technician-Paramedic (EMTP): Over 500 hours of training which encompasses the National Standard Paramedic Training Curriculum. Includes classroom, laboratory, hospital, and vehicle clinical instruction. Qualifies the student to sit for the National Registry of EMT's paramedic level examination. Twenty-three credit hours. Ohio Accreditation No. 5-3-005. EMTP 210, 211, 212, 220, 230, 231, 232, 240, 241, and 242.

Entrance Requirements

- EMTA:
 - Minimum of eighteen years of age
 - High school diploma or equivalent
 - Current driver's license
 - Complete physical examination
- AEMT-A:
 - All EMTA requirements
 - Certified Ohio EMTA
 - Six month's experience as EMT-A
 - EMS letter of recommendation
 - No felony criminal record
 - Conference with program director
- EMTP:
 - All EMTA and AEMT-A requirements
 - Successful completion of the National Registry of EMT's basic level exam
 - General aptitude examination

Enrollment Information

- EMTA:
 - Offered fall, winter, spring, and summer quarters.
- AEMT-A:
 - Fall Quarter. Recruitment occurs during summer quarter.
- EMT-Paramedic:
 - Offered sequentially, beginning fall quarter and ending spring quarter. Recruitment occurs during summer quarter.

Related Course Offerings

EMTP 101 First Aid and CPR—This course is the American Red Cross standard first aid and CPR course. Two credit hours.

EMTP 102 Cardiopulmonary Resuscitation—The AHA or Red Cross CPR course. One credit hour.

EMTP 215 Advanced EMT Defibrillation—This course qualifies the Ohio certified Advanced EMT-A to perform electrical defibrillation. Four credit hours. Offered fall quarter.

Upward Bound

The Shawnee State University Upward Bound program is funded through a grant from the U.S. Department of Education and serves Scioto County high school students. The program provides special services, activities, and classes (including a residential component in the summer) to students who want to attend college after graduation. Participants must meet low income guidelines as established by the federal government or be a potential first generation college student.

The Upward Bound office is located in the Commons Building and can be reached by calling (614) 355-2439.

Services.
Fees. and
Facilities



Tech Prep Ohio South Consortium

Tech Prep Ohio South is a consortium of schools, universities, business/industry, and agency representatives working in collaboration as part of a national educational reform movement. Combining secondary and postsecondary education programs through a formal articulation agreement, Tech Prep provides courses in a progressive, nonduplicative sequence, which lead to associate degrees in any number of technical and service careers.

Information about Tech Prep is available by contacting the director. The office is located in the Office of Continuing Education on the ground floor level of Massie Hall and may be reached by calling (614) 355-2281 or (614) 355-2490.

Project Discovery

Project Discovery is a State of Ohio- and National Science Foundation-sponsored effort to improve the quality of the teaching and learning of mathematics and science through research-based, long-term professional development for practicing teachers. The project initially focuses on middle and junior high school mathematics and science with inquiry-based instruction and the use of technology in teaching and learning. The South Region of Project Discovery includes a collaborative effort in eight southern Ohio counties and is housed in Shawnee State University's Vern Riffe Advanced Technology Center, room 308. For further information, call (614) 355-2304 or (614) 355-2239.



Center for Integrative Studies

The Center for Integrative Studies (CIS) is organized with its focus on the development of the general education core program. The center's activities include:

- (a) Pure and applied research in integrative studies
- (b) Core program evaluation
- (c) Curriculum review
- (d) Core faculty development and Senior Seminar faculty pool
- (e) Senior seminar paper awards
- (f) Core faculty retreat
- (g) International exchange of interdisciplinary scholars

The CIS is engaged in seeking external funding for many of its activities, especially for research, faculty development, and international exchange of scholars.

General Education Core

As a recently established four-year institution, Shawnee State University has the rare opportunity to create a general education program reflective of the best educational practices and responsive to the growing consensus on general education for the 21st century adult. Recent national reports on undergraduate education in America agree that the general education component of baccalaureate programs is in need of significant reform.

In addressing the options for general education, Shawnee State utilized the following assumptions as criteria for identifying an appropriate approach: knowledge is more interrelated than fragmented; introductions to specialized disciplines are rarely synoptic or reflective; and a community of scholars must be created in order to model the form and substance of an educated person. Discussions with both subject matter consultants and general education consultants resulted in the following approach to meet the core objectives of the national reports and Shawnee State's institutional distinctiveness.

As an indication of its commitment to general education, Shawnee State University's Mission Statement explicitly addresses the function of the core curriculum: "Recognizing the importance of knowledge, values, and cultural enrichment, Shawnee State University is committed to teaching students to think critically, to act ethically, and to communicate effectively. The University will foster scholarly inquiry, integrative learning, and an interdisciplinary approach to knowledge . . ."

The general education program assumes that incoming students are prepared for college-level work; therefore, admission to the core courses is predicated upon some combination of G.P.A. and college preparatory curriculum, ACT score, and competency/placement examinations. Each academic division defines the minimum knowledge/skills required by its core courses.

Throughout the course of their academic career at the University, students participate in a variety of assessment activities, especially at the freshman and senior seminar levels.

Throughout the general education core, students are expected to be active participants rather than passive observers. Indeed, student involvement is the key which transforms classroom activities into learning experiences. Involvement in group work, class participation, writing, field experiences, and hands-on skill development enables students to acquire life-long learning and thinking skills.

The following objectives are addressed by courses in the general education core in a manner appropriate to the subject matter.

Communication Skills

Reading

Students should leave the core with the ability to read on the college level and committed to reading regularly and over a broad spectrum of topics.

Entry level—to be tested. Minimum reading level is necessary to begin core courses; otherwise remediation is required.

Core course components—Textbooks are utilized and supplemented by readings from other sources.

Writing

Students should leave the core with the ability to write clearly, concisely, and creatively in a variety of formats.

Entry level—to be tested. Minimum writing level is necessary to begin core courses; otherwise remediation is required.

Core course components—Students write across the curriculum (research papers, technical reports, journals, creative writings).

Speaking

Students should leave the core with the ability to give a formal presentation to a group, participate actively in a group discussion, and debate a position rationally and persuasively.

Entry level—English language competence. Testing and remediation may be in order for some students.

Core course components—In all courses, students are exposed to a variety of speaking situations.

Quantitative

Students should leave the core with the ability to measure and calculate, to analyze data, and to evaluate the use of statistics.

Entry level—Students should be competent through high school algebra. If, upon testing, students are found to lack the necessary mathematics skills, remediation is required.

Core course components—Where appropriate, students utilize quantitative skills such as interpreting historical data, graphs, and charts and collecting and analyzing scientific or social information.

Computing

Students should leave the core with the skills necessary to function successfully in our computerized society.

Entry level—Keyboarding skills are valuable.

Core course components—Where appropriate, students use computers as part of each course (word processing when writing is required, statistical packages or spreadsheets for dealing with numbers, file management programs for handling information).

Integrative Knowledge and Understandings

Global Parameter—Students should leave the core understanding both the dynamic inter-connectedness of peoples and nations and the human longing for a sense of community.

Cultural Context—Students should leave the core with knowledge of the cultural traditions of North America and the complex historical/cultural/sociological contexts which inform contemporary experience.

Ecological Perspective—Students should leave the core understanding the interrelatedness of social, economic, environmental, technological, and political systems.

Ethical Foundation—Students should leave the core understanding that all decisions, whether personal, corporate, or financial, have an ethical dimension as well as a value orientation.

Aesthetic Consciousness—Students should leave the core with a greater appreciation of how the arts contribute to an enriched quality of life.

The general education goals of Shawnee State are met by three series of integrated and/or interdisciplinary courses and a mathematics course generally taken early in most students' programs plus three other courses taken in the junior and senior years. Each series includes three courses of four credit hours each. One series focuses on communication and thinking; a second on physical, biological, and social science; and the third on culture and intellectual history within an historical frame.

In addition to being integrated within the broad disciplines, each series reinforces elements of the other two series. Explicit relationships with other series are noted in the areas of subject matter, methodology, and identified competencies. The overarching goal of the general education core is to enable the student to acquire the basic abilities to function effectively in the multiple roles of contemporary life.

Communication and Thinking

Three courses are taken in sequence during the freshman year. The major emphasis revolves around the nature of words and symbols and how to order them through logical and critical thought processes. English composition, public speaking, and critical reading and listening skills are acquired throughout the sequence by the development of critical thinking skills. In addition to the attention to informal logic and reasoning, students are introduced to such quantitative "reasonings" as surveys, opinion polls, and other quantitative informative/persuasive tools. Students are expected to communicate their thoughts both in speaking and in writing with logic, clarity, and insightfulness.

Our World

This three-quarter series can be taken in either the freshman or sophomore year. (These courses do not need to be sequential although they will be discussed here as if they were.) As each particular domain of knowledge is explored, the disciplines represented also respond to critical probes of the following questions: What is the nature of its inquiry? Why did it develop as it has? How is it functioning in society today? And where are its limitations? The first course is an integrated course in the physical sciences emphasizing the nature of science and scientific methods, the history of the physical sciences, and the impact of the physical sciences on human society. The second course focuses on the scientific method used in the biological sciences as well as the history of the biological sciences and their impact on human society. The third course introduces the student to the breadth and depth of the influence of the social sciences in contemporary life.

All of the courses in this series address the development and consequences of the industrial and post-industrial ages; students are presented the interrelationships of the sciences, technology, economics, and public policy. Furthermore, each course confronts a range of ecological issues from global atmospheric pollution to individual/personal self-abusiveness.

Civilization and Literature

These three courses are based on an historical framework and integrate the impact of ideas, influence of form, and notations of taste and beauty. One major goal is to help students understand how our own culture has been informed, and to some extent formed, by our antecedents in Western culture. An American culture component pays special attention to the impact of political, social, and economic

ideas. The civilization and literature series also instills an appreciation of non-Western influences on our culture, of the multicultural nature of modern society, of the global interdependence which marks the modern world and non-Western cultures which we need to understand.

Each course in this series utilizes an historical frame, but the primary vehicle for the presentation of the material is various literary works. Furthermore, each course also includes the role of the creative and performing arts in the cultures being studied.

Quantitative and Qualitative

In addition to the three series, a general education mathematics course has been developed. Building upon a specified level of mathematical competence, this course includes questions about the nature of mathematical knowledge and the impact of mathematics on modern life. Extending the unit on formal and informal logic included in the communication series, this course focuses on skills in using and interpreting descriptive and inferential statistics.

Ethics in Public and Private Life and Senior Seminar, both general education courses, can be taken only during the junior and senior years. The ethics course, required either late in the junior year or during the senior year, treats professional ethics as well as ethical questions in society and in private lives. The goal is to encourage students to reflect on ethical problems and to develop intellectual skills involved in making difficult value decisions.

The senior seminar comes late in the students' university experience. A central part of the seminar will be a major paper in which students reflect on their own special fields in an interdisciplinary context with historical, ethical, and intellectual perspectives and integrate the various concepts which have been studied. To put this in a slightly different way, the senior seminar provides students with the opportunity to again write, speak, think, analyze, synthesize, and integrate—this time using the education they have acquired over four years. Furthermore, to enhance the possibility of a final interdisciplinary thrust, these seminars contain a mixture of majors so that students have to communicate with persons from other academic fields.

The final two hours are not a standard course. Students are required to participate in community service projects during their junior or senior year. In addition to providing real service to the community, this requirement promotes reflection on the nature of the obligation that students have to share the fruits of their higher education with those of their fellow citizens who are less fortunate.

General Education Core

ENGL 111S	Discourse and Composition	4 credit hours
ENGL 112S	Composition and Research	4 credit hours
ENGL 115S	Composition and Literature	4 credit hours
ENGL 225S or HIST 225S	Civilization and Literature 1	4 credit hours
ENGL 226S or HIST 226S	Civilization and Literature 2	4 credit hours
ENGL 227S or HIST 227S	Civilization and Literature 3	4 credit hours
PSCI 110S	Physical Science Core Course	4 credit hours
SOCI 110S	Foundations of Social Science	4 credit hours
BIOL 110S	Life Sciences Core Course	4 credit hours
MATH 110S	Mathematics Core Course	4 credit hours
PHIL 320S	Ethics in Public and Private Life	4 credit hours
¹ 485S	Community Involvement	2 credit hours
¹ 490S	Senior Seminar	4 credit hours
Total		50 credit hours

¹ Prefix varies according to student's academic major: BADM, ENGL, ETCO, NTSC, or SOCI

Programs of Study at Shawnee State

College of Arts and Sciences

Department of Arts and Humanities

Bachelor of Arts

- English/Humanities—General
- English/Humanities—Elementary

Education

Associate of Arts

- Arts/Humanities—General
- Arts/Humanities—Art
- Arts/Humanities—Communications
- Arts/Humanities—English
- Arts/Humanities—Music
- Arts/Humanities—Theatre

Department of Mathematics

Bachelor of Science

- Natural Science/Applied Mathematics
- Nat. Science/Applied Math./Elem. Ed.

Associate of Science

Mathematics

Department of Natural Sciences

Bachelor of Science

- Natural Science
- Natural Science/Elementary Education
- Natural Science/Chemistry
- Natural Science/Environmental Science
- Natural Science/Life Science
- Natural Science/Physical Science
- Natural Science/Pre-Medicine
- Natural Science/Pre-Veterinary

Associate of Science

- Sciences
- Sciences—Botany
- Sciences—Chemistry
- Sciences—Physics
- Sciences—Zoology

Department of Social Sciences

Bachelor of Arts

- Social Sciences
- Social Sciences/Elementary Education
- Social Sciences/History
- Social Sciences/Legal Assisting (2+2)
- Social Sciences/Pre-Law
- Social Sciences/Psychology
- Social Sciences/Sociology

Associate of Arts

- Social Science
- Social Science/Government
- Social Science/History
- Social Science/Psychology
- Social Science/Sociology

College of Business

Bachelor of Science

- Business Administration/General

College of Business (cont'd.)

Associate of Applied Business

- Accounting/Professional
- Accounting/Management
- Business Mgt./Management
- Business Mgt./Banking and Finance
- Business Mgt./Real Estate
- Business Mgt./Retail Management
- Business Mgt./Small Business¹
- Computer Information Systems in Business
- Legal Assisting
- Office Administration/Executive
- Office Administration/General

College of Engineering Technologies

Bachelor of Science

- Plastics Engineering Technology
- Electrical and Computer Engineering Technology

Associate of Applied Science

- Plastics Engineering Technology
- Electromechanical Engineering Technology
- (Optional Major in Robotics)
- Instrumentation and Control Engineering Technology (Optional Major in Robotics)
- Computer Aided Drafting and Design

Certificate

- Computer Aided Drafting and Design (CADD)

College of Health Sciences

Bachelor of Applied Science¹

- Concentration in Health Management

Bachelor of Science in Occupational Therapy¹

Associate of Applied Science

- Associate Degree Nursing
- Dental Hygiene
- Emergency Medical Technology¹
- Medical Laboratory Technology
- Occupational Therapy Assistant
- Physical Therapist Assistant
- Radiologic (X-ray) Technology
- Respiratory Therapy

Certificate

- EMT

Center for Teacher Education

- Education
- Education/Elementary

¹ Pending approval.

College of
Arts and
Sciences

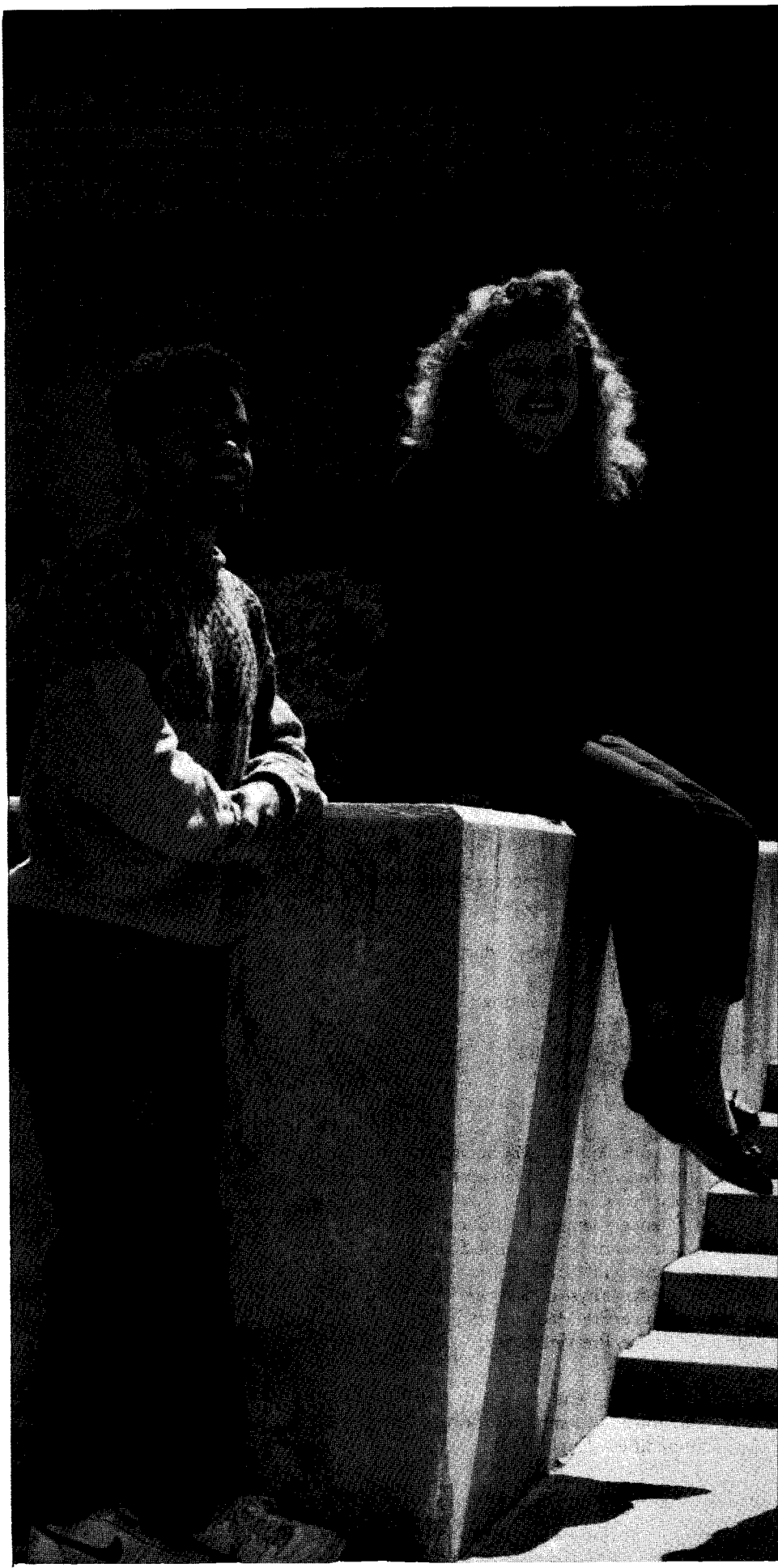

1993-1995
Shawnee State University

57

Mission of the College of Arts and Sciences

The overall mission of the College of Arts and Sciences is liberal arts education and career preparation of Shawnee State students. Liberal arts education provides graduates with intellectual skills, substantive knowledge, and habits of the mind that promise rewarding careers and the more abundant life.

Courses in the College of Arts and Sciences contribute to the student's capability for abstract and systematic analysis and comprehension of the scientific method and encourage appreciation for and understanding of the varieties of artistic expression. These courses contribute to the flexibility to reconceptualize problems in pursuit of alternative solutions and the communication and interpersonal skills essential for sharing these ideas in an increasingly collaborative and global workplace.

Liberal arts education at Shawnee State incorporates the teaching of these skills into a program that alerts students to the complexity of human history and diversity of cultures while exploring alternative approaches to contemporary social, economic, and political issues. Acknowledging the moral dimension of many of these questions, the liberal arts program explores ethical approaches and encourages each student to develop a personal philosophy of life.

The University's commitment to liberal education begins with the College of Arts and Sciences' integrative Core Curriculum, which emphasizes critical thinking. Building on the Core foundation, the College provides a spectrum of liberal arts degree programs in the arts and humanities, mathematics, the natural sciences, and the social sciences, including interdisciplinary programs and programs leading to teacher certification. These degree programs prepare graduates for careers or successful matriculation into graduate and professional degree programs.

Degrees Offered by the College of Arts and Sciences

Bachelor of Arts

- English/Humanities—Elementary Education
- English/Humanities—General
- Social Sciences
- Social Sciences/Elementary Education
- Social Sciences/History
- Social Sciences/Legal Assisting (2 + 2)
- Social Sciences/Pre-Law
- Social Sciences/Psychology
- Social Sciences/Sociology

Bachelor of Science

- Natural Science
- Natural Science/Applied Mathematics
- Natural Science/Applied Mathematics/Elementary Education
- Natural Science/Chemistry
- Natural Science/Elementary Education
- Natural Science/Environmental Science
- Natural Science/Life Science
- Natural Science/Physical Science
- Natural Science/Pre-Medicine
- Natural Science/Pre-Veterinary

Associate of Arts

- Arts/Humanities—Arts
- Arts/Humanities—Communications
- Arts/Humanities—English

Associate of Arts (cont'd.)

Arts/Humanities—General
Arts/Humanities—Music
Arts/Humanities—Theatre
Social Science
Social Sciences/Government
Social Sciences/History
Social Sciences/Psychology
Social Sciences/Sociology

Associate of Science

Mathematics
Sciences
Sciences—Botany
Sciences—Chemistry
Sciences—Physics
Sciences—Zoology

Faculty: A Commitment to Teaching, Scholarship/Research and Creative Activities, and Service

The College of Arts and Sciences' faculty are dedicated and talented individuals. Their graduate degrees are from the finest universities in the world, and they care deeply about the personal growth and academic success of their students. The outstanding talent and achievements of our alumni are due, in large part, to the high quality of teaching of the faculty.

Quality teaching is the primary emphasis of the College, and its faculty are dedicated to extending the frontiers of knowledge. This means they are contributing to the body of significant research and scholarly work and creative activities in their disciplines as well as providing service to the community, region, state, and nation.

Selecting and Declaring a Degree Major

Students should consider a choice of major and career early in their degree program, if not before. Students are encouraged to seek the advice of College of Arts and Sciences faculty and, also, staff in the Office of Counseling and Career Services. A student's own interests, aptitudes, and professional/career aspirations should play a central role in selecting a degree major.

Academic Advising

The College of Arts and Sciences is committed to quality academic advising, because it is essential to the ultimate success of our students. Once a student has selected a major, he or she is advised by the teaching faculty of that department. Department chairpersons assign students to an academic faculty advisor, ensuring that the departmental academic advising system meets the needs and requirements of the individual student, the department, the College, and the University. The dean of the College of Arts and Sciences facilitates answers to interdivisional questions and exceptions and changes to related academic requirements.

Baccalaureate Degree Requirements

The College of Arts and Sciences awards its baccalaureate degrees to students who meet the following minimum requirements. Please see individual degree programs for any additional requirements.

- A minimum of 186 credit hours, including 50 credit hours of General Education Core.
- A minimum of 2.00 cumulative grade point average for all courses taken at Shawnee State University.
- Completion of at least 45 credit hours at Shawnee State University, of which 35 credit hours must be the upper division courses (300-400 level courses).
- A minimum of 60 credit hours in the major field of study.
- Petition for graduation in accordance with the rules prescribed by the University.

Minors

A minor is an additional field of study, to the baccalaureate degree, that may be taken to widen a student's area of interest or increase a student's career opportunities. Consult with specific departments for information regarding minor offerings and minor field of study course requirements. Taking a minor is optional and not required.

Associate Degree Requirements

The College of Arts and Sciences offers several programs of study leading to two-year associate degrees. The associate degree programs allow students immediate job entry or transfer into certain baccalaureate degree programs. Specific requirements for each degree are in the related departmental section.

Preparation for Elementary Education Certification

Students seeking elementary education certification must elect a major in the College of Arts and Sciences and complete the related B.A. or B.S. degree requirements. At the same time, the student must complete the Professional Education Requirements as well as other eligibility criteria for elementary education certification. Each student is responsible for related academic advising with a Center for Teacher Education faculty advisor on certification matters.

Course Scheduling and Offerings

The College of Arts and Sciences is committed to scheduling classes on a rotating basis, which will allow completion of programs, to the extent possible, for students pursuing degree programs during the day and/or evening. Students are encouraged to discuss specific course scheduling issues with their academic major advisor or chairperson/dean.

Pass/No-Credit Policy

Students in the College of Arts and Sciences are not permitted to take courses in their major on a pass/no-credit basis.

Department of Arts and Humanities

College of
Arts and
Sciences

Mission

The mission of the Department of Arts and Humanities is to develop students who can think and read critically, write and speak clearly, and who understand the contributions literature, art, music, and philosophy can make to the quality of daily life. The department believes that the skills of reading, writing, and thinking are the foundations upon which a successful college career is built, and, therefore, all areas within the department accept as part of their charge the continuous development of writing and speaking skills. To this end, the department is committed to providing opportunities for the integrated study of a variety of art forms as well as to infusing its academic programs with American, international, and multi-cultural perspectives.

Bachelor of Arts with a Major in English/Humanities

The Department of Arts and Humanities offers a bachelor of arts degree with a major in English/Humanities. This degree requires 68 quarter hours: 44 hours from English, 20 hours from a variety of humanities offerings, and 4 hours of philosophy.

Students seeking certification in elementary education may want to select English/Humanities as their major, because a strong background in the language arts is essential for elementary school teachers. Other students may want to receive a degree without elementary certification. These students are required to complete 68 additional hours of electives. Careers in journalism, advertising, public relations, and many pre-professional programs, such as law, require excellent communication skills.

The Department strongly recommends that students who are not pursuing elementary certification focus on areas of specialization chosen from a variety of electives. For example, some students may want to complete two or three years of foreign language while others may want to concentrate in art, philosophy, additional English, social science, mathematics/science, or business. These areas of specialization should strengthen a graduate's chance for employment. In addition, the Department is in the process of developing some specific minors and concentrations which may be available before a new catalog is published. One such program in development is the bachelor of fine arts degree in art, a professional program designed to provide career artists with the basic tenets of their chosen profession while at the same time preparing them to enter advanced degree programs. Check with your advisor as to the progress of these programs.

Important Note: Because of the need to avoid duplication of course requirements for elementary certification students and to plan an effective course of electives for those students not seeking elementary certification, the Department strongly recommends that each student see an advisor each quarter.

Degree Requirements

General Education Core
English/Humanities Courses *(Includes 20-hour elective block
of which 4 hours must be above 300 level.)*

50 Hours

68 Hours

1993-1995
Shawnee State University

61

Degree Requirements (cont'd.)

Electives (*Note: Beginning with June 1990, at least 24 hours of these electives must be from 300 and 400 level courses. The Department strongly recommends that students take specialized courses in one or two areas. Foreign language is an excellent area of specialization for English/Humanities majors.*) 68 Hours

**Total Hours Required for
Bachelor of Arts with Major in English/Humanities** 186 Hours

General Education Core (50 Hours)

Course No.	Course	Credit Hours
ENGL 111S	Discourse and Composition	4
ENGL 112S	Composition and Research	4
ENGL 115S	Composition and Literature	4
ENGL/HIST 225S	Civilization and Literature 1	4
ENGL/HIST 226S	Civilization and Literature 2	4
ENGL/HIST 227S	Civilization and Literature 3	4
PSCI 110S	Physical Science Core Course	4
SOCI 110S	Foundations of Social Science	4
BIOL 110S	Life Sciences Core Course	4
MATH 110S	Mathematics Core Course	4
PHIL 320S	Ethics in Public and Private Life	4
SOCI 485S	Community Involvement	2
SOCI 490S	Senior Seminar	4

English/Humanities Courses (68 Hours)

Area	Credit Hours
Philosophy	4
Introduction to Literature (ENGL 200)	4
Linguistics (ENGL 360/LING 270, ENGL/LING 362 or 365, and ENGL 460)	8
Survey of Literature (ENGL 211, 212, 251, or 252)	8
Shakespeare (ENGL 301 or 302)	4
Theory and Practice in Composition (ENGL 315)	4
Literature Before 1800 (ENGL 311, 411, 421, and other suitable courses)	4
Literature After 1800 (ENGL 312, 321, 322, 441, 446, and other suitable courses)	4
American Literature (ENGL 273, 351, 371, 461, 471, and other suitable courses)	4
Literature as Social Perspective (ENGL 341, 342, 343, 344, 346, 349, 383, and other suitable courses)	4
Humanities Electives (Courses must be taken in at least two areas with four hours at the 300 level or higher)	20
Art History	
Music History	
Foreign Language	
Philosophy	
Linguistics (one additional course)	
Other suitable courses as added	

English/Humanities Curriculum

The following quarterly course sequence is only a suggestion. Students should work with their advisors to arrange a sequence more appropriate to their needs.

1993-1995
Shawnee State University

62

Course No.	Course	Credit Hours
	FIRST QUARTER	
ENGL 111S	Discourse and Composition	4
HUMN	Elective	4

	FIRST QUARTER (cont'd.)	
MATH 110S	Mathematics Core Course	4
	Elective	4
	Total	16
	SECOND QUARTER	
ENGL 112S	Composition and Research	4
SOCI 110S	Foundations of Social Science	4
HUMN	Elective	4
	Elective	4
	Total	16
	THIRD QUARTER	
ENGL 115S	Composition and Literature	4
ENGL 200	Introduction to Literature	4
HUMN	Elective	4
	Elective	4
	Total	16
	FOURTH QUARTER	
ENGL 225S	Civilization and Literature 1	4
ENGL 211	Survey of English Literature 1 (or ENGL 251 Survey of American Literature 1)	4
PSCI 110S	Physical Science Core Course	4
	Elective	4
	Total	16
	FIFTH QUARTER	
ENGL 226S	Civilization and Literature 2	4
ENGL 212	Survey of English Literature 2 (or ENGL 252 Survey of American Literature 2)	4
HUMN	Elective	4
	Elective	4
	Total	16
	SIXTH QUARTER	
ENGL 227S	Civilization and Literature 3	4
PHIL	Elective	4
BIOL 110S	Life Sciences Core Course	4
HUMN	Elective	4
	Total	16
	SEVENTH QUARTER	
PHIL 320S	Ethics in Public and Private Life	4
LING 270	Introduction to Language and Linguistics	4
ENGL 315	Theory and Practice in Composition	4
	Electives	8
	Total	20
	EIGHTH QUARTER	
ENGL 362	Patterns of English (or ENGL 365 History of English)	4
ENGL 301	Shakespeare 1 (or ENGL 302 Shakespeare 2)	4
	Electives	8
	Total	16
	NINTH QUARTER	
	Electives	16
	Total	16
	TENTH QUARTER	
ENGL 490S	Senior Seminar	4
	Literature as Social Perspective (select one course)	4
	Elective	4
	Total	12

ELEVENTH QUARTER		
ENGL 485S	Community Involvement	4
	Electives	8
	Total	12
TWELFTH QUARTER		
	Literature After 1800 (select one course)	4
	American Literature (select one course)	4
	Electives	8
	Total	16

English/Humanities Major with Elementary Education Certification

Degree Requirements

General Education Core (As listed on page 62.)	50 Hours
English/Humanities Courses	68 Hours
Arts and Sciences Requirements (NOTE: Students may doublecount 15 hours toward their English/Humanities major)	37 Hours
Professional Education Requirements	45 Hours
Total Hours Required for Bachelor of Arts Degree with English/Humanities Major and Elementary Education Certification	200 Hours

English/Humanities Courses (68 Hours)

Area	Hours
Philosophy	4
Introduction to Literature (ENGL 200)	4
Linguistics (ENGL 360/LING 270, ENGL/LING 362 or 365, or ENGL 460)	8
Survey of Literature (ENGL 211, 212, 251, or 252)	8
Shakespeare (ENGL 301 or 302)	4
Theory and Practice in Composition (ENGL 315)	4
Children's Literature (required of elementary education certification only)	4
Literature After 1800 (ENGL 312, 321, 322, 441, 446, and other suitable courses)	4
American Literature (ENGL 273, 351, 371, 461, 471, and other suitable courses)	4
Literature as Social Perspective (ENGL 341, 342, 343, 344, 346, 349, 383, and other suitable courses)	4
Humanities Electives (Courses must be taken in at least two areas with four hours at the 300 level or higher)	20
Art History	
Music History	
Foreign Language	
Philosophy	
Linguistics (one additional course)	
Other suitable courses as added	

NOTE: Students receiving Elementary Education Certification who started prior to June 1989 may take four hours of linguistics instead of eight. These students may take Literature Before 1800. Students taking only four hours of linguistics must take English 360/LING 270.

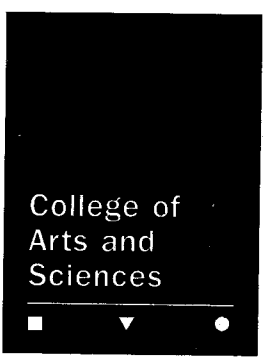

Arts and Sciences Requirements (37 Hours)

Course No.	Course	Credit Hours
ARTS 201	Art in the Elementary Curriculum 1	3
ARTS 202	Art in the Elementary Curriculum 2	3
MUSI 160	Fundamentals of Music	3
MUSI 161	Music for the Classroom Teacher	3
MATH 120	Elementary Topics in Mathematics 1	5
MATH 121	Elementary Topics in Mathematics 2	5
HPER 202	Personal and Community Health	4
HPER 270	Physical Education for the Elementary Classroom	4
PSYC 375	Educational Psychology	4
SPCH 103	Public Speaking and Human Communication	3

Professional Education Requirements (45 Hours)

Course No.	Course	Credit Hours
EDUC 110	Teacher as Inquiring Professional 1	2
EDUC 210	Teacher as Inquiring Professional 2	2
EDUC 220	Social/Physical/Intellectual Growth and Development	3
EDUC 230	Instructional Media, Technology, and Computers	2
EDUC 240	Foundations and Competing Epistemologies 1	2
EDUC 310	Teacher as Inquiring Professional 3	3
EDUC 320	Interdisciplinary Teaching Methods 1	7
EDUC 340	Foundations and Competing Epistemologies 2	2
EDUC 420	Interdisciplinary Teaching Methods 2	7
EDUC 450	Directed Teaching and Seminar	15

Note: As a general rule, no 300 or 400 level education courses will be transferred.

Associate Degree Programs

Associate of Arts Degree: Humanities Concentration

Shawnee State University offers an associate of arts degree for those students wishing to complete a two-year program of general education with an emphasis in the arts. The total number of hours needed to complete the degree is 90.

Curriculum

I. Core Requirements

A. Composition — 12 hours minimum

ENGL 111S Discourse and Composition (4); ENGL 112S Composition and Research (4); ENGL 115S Composition and Literature (4)

Students may take additional courses from the following (optional): ENGL 232 (3); ENGL 240 (3); ENGL 245 (3)

B. Mathematics — 4 hours minimum

MATH 110S Mathematics Core Course (4)

Students may choose additional mathematics courses from the following (optional): MATH 131 (4); MATH 132 (4); MATH 201 (4); MATH 202 (4); MATH 250 (4); MATH 255 (4)

C. Arts and Humanities — 16 hours minimum (choose from two areas)

ENGL/HIST 225S Civilization and Literature (4)

and two courses from the following: ARTS 262 (4); ARTS 261 (4); ENGL 200 (4); MUSI 220 (3); PHIL 101 (4)

and one course from the following: Art, English, Humanities, Journalism, Language, Music, Philosophy, or Theatre

Students may choose additional courses from the following (optional): ENGL 203 (4); ENGL 210 (4); ENGL 211 (4); ENGL 212 (4); MUSI 221 (3); MUSI 222 (3); MUSI 223 (3); PHIL 102 (4); PHIL 103 (4); PHIL 105 (4)

- D. Social Science — 16 hours minimum (choose from two areas)
 SOCI 110S Foundations of Social Science (4); HIST/ENGL 226S Civilization and Literature 2 (4); SOCI 101 Introduction to Sociology (4); or PSYC 101 Introduction to Psychology (4) and one course from the following: ECON 101 (4); GEOG 125 (4); GOVT 101 (4); HIST 111 (4); HIST 112 (4); HIST 113 (4); PSYC 101 (4); SOCI 101 (4)
 Students may choose additional courses from the following (optional): ANTH 101 (4); ANTH 250 (4); ECON 102 (4); GOVT 102 (4); GOVT 120 (4); GOVT 250 (4); HIST 201 (4); HIST 202 (4); HIST 203 (4); PSYC 151 (4); PSYC 273 (4); SOCI 201 (4); SOCI 205 (4)
- E. Natural Sciences — 12 hours minimum
 BIOL 110S Life Sciences Core Course (4); PSCI 110S Physical Science Core Course (4) and one or more of the following: BIOL 151 (5) (3 lec./4 lab); CHEM 121 (4), CHEM 122 (4); CHEM 141 (4); CHEM 142 (4); CHEM 143 (4) (all CHEM - 3 lec./3 lab); PHYS 201 (4); PHYS 202 (4); PHYS 203 (4) (all PHYS - 3 lec./3 lab); GEOL 101 (4) (3 lec./2 lab)
 Students may choose additional courses from the following (optional): BIOL 162 (5); BIOL 170 (4); BIOL 202 (5); BIOL 203 (6); CHEM 200 (4); CHEM 201 (4); GEOL 112 (4); PHYS 210 (4)
Note: Students cannot receive credit for both CHEM 121/122 and CHEM 141/142 series.

II. Concentration Area — 30 hours

A. Arts

Selected courses in an area of specialization chosen from the following list of humanities subject areas to complete the associate of arts degree.

Art	Humanities	Music
Comparative Arts	Journalism	Philosophy
English	Language	Theatre

B. Social Sciences

Selected courses in an area of specialization chosen from the following list of subject areas to complete the associate of arts degree:

Anthropology	Government	Psychology
Economics	History	Sociology
Geography		

Associate of Individualized Studies Degree

The associate of individualized studies degree (AIS) at Shawnee State University is designed to allow students the option of formulating their own individualized program of study. The philosophical basis of the degree is predicated upon the assumption that students may be unable to achieve their personal educational goals through one of the more formalized two-year degree structures offered at Shawnee State. This is especially true for students interested in concentrating or combining a selected mixture of courses encompassing both academic as well as technical offerings in a manner which may not meet the degree requirements of Shawnee State's associate of arts, associate of applied science, or associate of applied business degrees. Students desiring more information concerning this degree should contact the registrar.

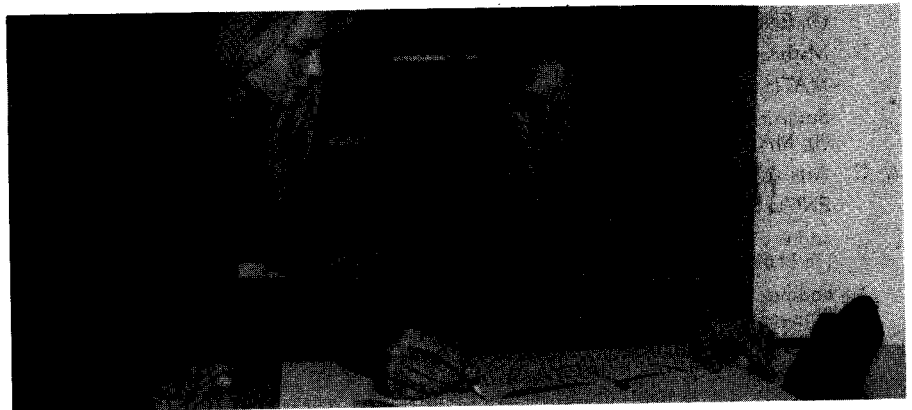

Department of Mathematics

Mission

The mission of the Department of Mathematics is threefold:

1. to provide the general education student with an appreciation of, and experiences with, the role of mathematics in our society.
2. to develop additional mathematical skills for those students whose academic programs require it.
3. to provide educational experiences for students desiring to specialize in mathematics.

Bachelor of Science in Natural Science

The Department of Mathematics supports and participates in Shawnee State University's bachelor of science in natural science degree program. The purpose of this program is to introduce students to a wide range of basic science disciplines and to concentrate on one specific area as well. By selecting mathematics as the primary area of concentration, students may complete the requirements for the bachelor of science in natural science with a concentration in applied mathematics.

A number of career alternatives are available to students who complete this degree, including positions in government or industry that require quantitative competency, continued specialization in graduate school, and, when combined with the elementary education certification option, a career in elementary school teaching.

Degree Requirements

General Education Core (<i>As listed on page 62.</i>)	50 Hours
Concentration Area 1 - Mathematics <i>Courses numbered higher than MATH 110S. In addition, coursework should include MATH 201, 202, and at least 12 hours at the 300-400 level</i>	32 Hours
Concentration Area 2 <i>Biology, chemistry, geology, or physics courses numbered higher than 110</i>	16 Hours
Concentration Area 3 <i>Biology, chemistry, geology, or physics courses (selected from area other than Concentration Area 2) numbered higher than 110</i>	8 Hours
Senior Project in Mathematics (<i>MATH 496 and 497</i>)	4 Hours
Humanities and Social Science Electives <i>From at least two areas</i>	24 Hours
Mathematics Electives <i>Numbered higher than MATH 110S</i>	8 Hours
Computer Science Elective <i>Students should select an appropriate computer science course in consultation with a departmental advisor.</i>	4 Hours
General Electives	45 Hours
Total Hours Required for Bachelor of Science Degree in Natural Science with Concentration in Applied Mathematics	191 Hours

Note: A minimum of 35 hours must be at the 300 level or above.

Mathematics at Shawnee State University

Degree-seeking students are required to take a mathematics placement test to determine in which mathematics class they should be enrolled. Entry to the mathematics sequence can occur at any point, depending on the student's mathematics placement test score, ACT mathematics score, and high school mathematics background and grades. Many of the mathematics courses are sequential, so it is

important that students master the material in one course before moving on to the next.

The following diagram shows the normal progress through the mathematics courses. Only MATH 120 and 121 must be preceded by other Shawnee State University mathematics courses. All other courses can be entered as a result of placement.

Questions about placement or the appropriate course(s) for a student should be addressed to the Department of Mathematics.

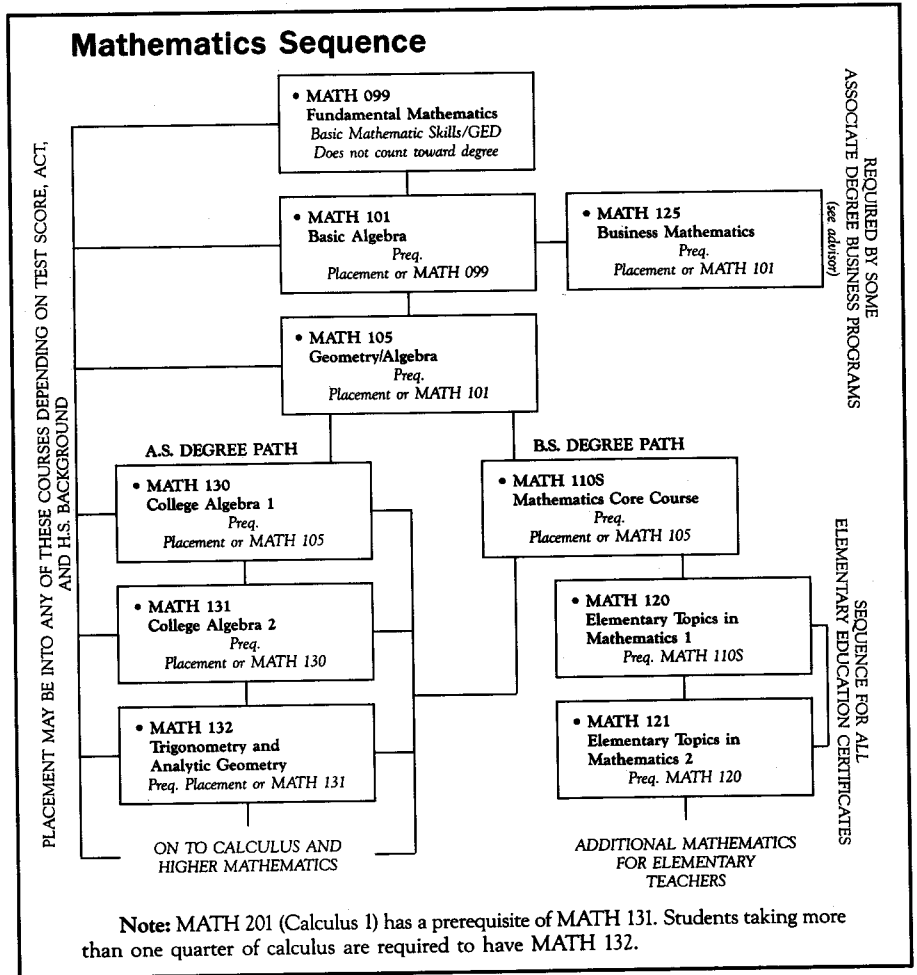

Elementary Education Certification

Students seeking a bachelor of science in natural science degree who wish to be certified in elementary education must also complete the coursework listed below. It is important to note that these courses are not in addition to the degree requirements listed on page 67 but rather take the place of certain electives. *Students are urged to work closely with their mathematics advisor and with an advisor from the elementary education program.*

Degree Requirements

General Education Core (As listed on page 62.)

Concentration Area 1 - Mathematics (Any 32 hours of mathematics above MATH 110S. MATH 201 and MATH 305 are required. In addition, at least 9 hours must be numbered 300 or above.)

50 Hours

32 Hours

Degree Requirements (cont'd.)

Concentration Area 2 (<i>To be selected from one science area: biology, chemistry, geology, or physics. Courses must be numbered higher than the core.</i>)	16 Hours
Concentration Area 3 (<i>To be selected from one science area not chosen for Concentration Area 2. Courses must be numbered higher than the core.</i>)	8 Hours
Senior Project in Mathematics (<i>MATH 496 and 497</i>)	4 Hours
Computer Science Elective (<i>To be selected in consultation with a departmental advisor.</i>)	4 Hours
Arts and Sciences Requirements (<i>As listed on page 65.</i>)	37 Hours
Professional Education Requirements (<i>As listed on page 65.</i>)	45 Hours
Total Hours Required for Bachelor of Science Degree in Natural Science with Concentration in Applied Mathematics and Elementary Education Certification	196 Hours

Associate Degree Programs

The Department of Mathematics offers two associate degree programs, the associate of science and the associate of individualized studies.

The associate of science degree with a concentration in mathematics provides a firm foundation in college level mathematics which can be used in employment, in pursuing a bachelor's program in mathematics, or as preparation for other bachelor programs requiring such a foundation.

For those students having unique circumstances or goals, the associate of individualized studies provides an opportunity to tailor an educational program to meet individual needs.

For additional information about the associate degree programs in mathematics, contact the Department of Mathematics.

Associate of Science Degree: Mathematics Concentration

Shawnee State University offers an associate of science degree for those students desiring two years of general education with an emphasis in science and mathematics. The total number of hours needed to complete the degree is 90.

Curriculum

I. Core Requirements

A. Communications — 12 hours minimum

ENGL 111S Discourse and Composition (4); ENGL 112S Composition and Research (4); ENGL 115S Composition and Literature (4)

Students may take additional courses from the following (optional): ENGL 232 (3); ENGL 240 (3); ENGL 245 (3)

B. Mathematics — 8 hours minimum

MATH 110S Mathematics Core Course (4)

and one additional course from the following: MATH 131 (4); MATH 132 (4); MATH 201 (4); MATH 202 (4); MATH 250 (4); MATH 255 (4)

C. Arts/Humanities — 12 hours minimum (choose from two areas)

ENGL/HIST 225S Civilization and Literature (4)

and two of the following: ARTS 261 (4); ARTS 262 (4); ENGL 200 (4); MUSI 220 (3); PHIL 101 (4)

Students may take additional courses from the following (optional): ENGL 203 (4); ENGL 210 (4); ENGL 211 (4); ENGL 212 (4); MUSI 221 (3); MUSI 222 (3); MUSI 223 (3); PHIL 102 (4); PHIL 103 (4); PHIL 105 (4)

- D. Social and Behavioral Sciences — 12 hours minimum (choose from two areas)
SOC1 110S Foundations of Social Science (4); ENGL/HIST 226S Civilization and Literature 2 (4)
and one of the following: ECON 101 (4); GEOG 125 (4); GOVT 101 (4); HIST 111 (4); HIST
112 (4); HIST 113 (4); PSYC 101 (4); SOC1 101 (4)
Students may take additional courses from the following (optional):
ANTH 101 (4); ANTH 250 (4); ECON 102 (4); GOVT 102 (4); GOVT 120 (4); GOVT 250
(4); HIST 201 (4); HIST 202 (4); HIST 203 (4); PSYC 151 (4); PSYC 273 (4); SOC1 201 (4); SOC1
205 (4)
- E.¹ Natural Sciences/Physical Sciences — 16 hours minimum
BIOL 110S Life Sciences Core Course (4); PSCI 110S Physical Science Core Course (4)
Select two or more courses from the following: BIOL 151 (5) (3 lec./4 lab); CHEM 121 (4); CHEM
122 (4); CHEM 141 (4); CHEM 142 (4); CHEM 143 (4) (all CHEM - 3 lec./3 lab); GEOL 101
(4) (3 lec./2 lab); PHYS 201 (4); PHYS 202 (4); PHYS 203 (4) (all PHYS - 3 lec./3 lab)
Students may take additional courses from the following (optional): BIOL 162 (5); BIOL 170
(4); BIOL 202 (5); BIOL 203 (6); CHEM 200 (4); CHEM 201 (4); GEOL 112 (4); PHYS 210 (4)
- II. Concentration Area — 30 hours
Selected courses in an area of specialization chosen from the following subject areas complete the
associate of science degree.
Life Sciences
Mathematics
Physical Sciences

Associate of Individualized Studies Degree

The associate of individualized studies degree (AIS) at Shawnee State University is designed to allow students the option of formulating their own individualized program of study. The philosophical basis of the degree is predicated upon the assumption that students may be unable to achieve their personal educational goals through one of the more formalized two-year degree structures offered at Shawnee State. This is especially true for students interested in concentrating or combining a selected mixture of courses encompassing both academic as well as technical offerings in a manner which may not meet the degree requirements of Shawnee State's associate of arts, associate of applied science, or associate of applied business degrees. Students desiring more information concerning this degree should contact the registrar.

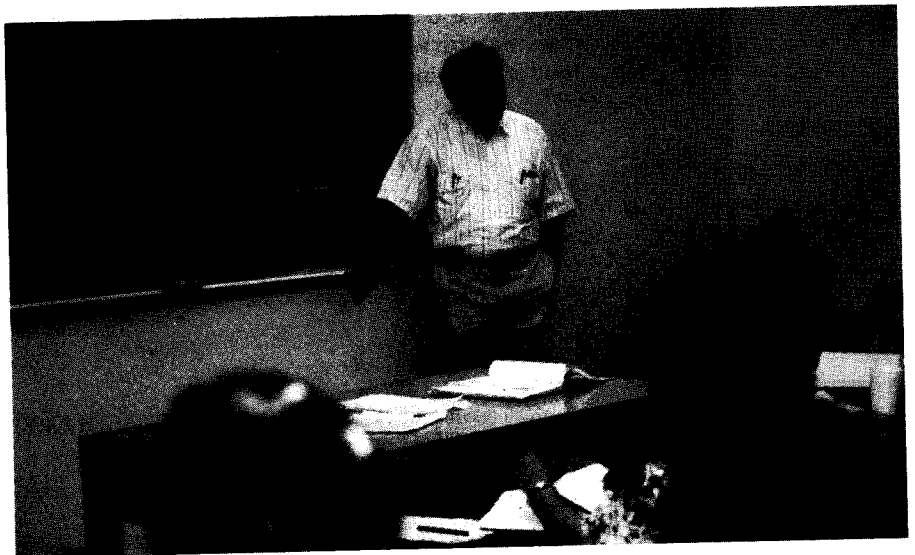

¹ Students cannot receive credit for both CHEM 121/122 and CHEM 141/142 series.

Department of Natural Sciences

Mission

The purpose of the Department of Natural Sciences is to prepare the general education student to live and succeed in an increasingly complex and technological world. The goal of placing science into perspective in modern society is developed further for students majoring in natural science. These students obtain a solid base of understanding across science disciplines while building depth in an area of concentration to prepare for future careers.

Bachelor of Science in Natural Science

Graduates who are well versed in science and mathematics are in demand in business, government, education, and industry. Evidence suggests that this demand will increase in the future as the world becomes more technologically sophisticated. In order to meet that demand, the bachelor of science in natural science has been designed to provide Shawnee State's students with a foundation, well grounded in the sciences and mathematics, which allows for a variety of career options.

The degree program requires students to study in three different disciplines of science and/or mathematics, offering the kind of flexibility that prepares students for careers in the life, physical, or environmental sciences. In addition, the degree program offers a solid foundation for continuing one's education in these fields or in the medical sciences. For students pursuing a career in elementary education, requirements for elementary certification can be completed concurrently with the degree program in natural science. All students should discuss their options with a faculty advisor.

Degree Requirements

General Education Core (<i>As listed on page 62.</i>)	50 Hours
Concentration Area 1 <i>Biology or chemistry courses (above 110 and at least 12 hours above 300 level), 32 hours. Senior Project, 4 hours</i>	36 Hours
Concentration Area 2 <i>Biology, chemistry, geology, physics, or mathematics courses (above 110)</i>	16 Hours
Concentration Area 3 <i>Biology, chemistry, geology, physics, or mathematics courses (above 110)</i>	8 Hours
Humanities and Social Sciences Electives <i>Courses with prefixes (excluding core courses) – SOCI, GEOG, GOVT, PSYC, ECON, HIST, ANTH, HUMN, ENGL, PHIL, LING, SPCH, THAR, SPAN, ARTS, MUSI, JOUR, FREN</i>	24 Hours
Mathematics Electives <i>MATH 120, 121 (elementary education students), or MATH 130 or above.</i>	8 Hours
Computer Science Elective	4 Hours
General Electives	45 Hours
Total Hours Required for Bachelor of Science Degree in Natural Science	191 Hours

Example 1 (actual program may vary)

Bachelor of Science in Natural Science with concentration in chemistry

General Education Core (<i>As listed on page 62.</i>)	50 Hours
Concentration 1 in chemistry CHEM 141, 142, 143, 223, 305, 306, 307, 331, 485	37 Hours

Concentration 2 in mathematics MATH 132, 201, 202, 203	16 Hours
Concentration 3 in physics PHYS 211, 212	8 Hours
Humanities/Social Science Electives Courses with prefixes (excluding core courses)— SOC, GEOG, GOVT, PSYC, ECON, HIST, ANTH, HUMN, ENGL, PHIL, LING, SPCH, THAR, SPAN, ARTS, MUSI, JOUR, FREN. (Students may take several courses in one of these disciplines.)	24 Hours
Mathematics Electives MATH 130, 131	8 Hours
Computer Science Elective CISB 101 or AISM 101	4 Hours
General Electives¹ CHEM 325, 341, 432, 433, PHYS 213 Other hours as needed.	45 Hours

Elementary Education Certification

Students seeking a bachelor of science in natural science who wish to be certified in elementary education must also complete the requirements listed on the next page. It is important to note that these requirements are not entirely in addition to the bachelor of science degree but rather meet certain electives, such as the mathematics requirement, humanities/social science electives, and general electives. Students will have some additional hours to meet all of the requirements. Students are urged to discuss the elementary education option with their primary advisor in the Department of Natural Sciences and their advisor in the Center for Teacher Education.

Degree Requirements

General Education Core (As listed on page 62.)	50 Hours
Concentration Area 1 <i>Biology or chemistry courses (above 110 and at least 12 hours above 300 level), 32 hours. Senior Project, 4 hours</i>	36 Hours
Concentration Area 2 <i>Biology, chemistry, geology, physics, or mathematics courses (above 110)</i>	16 Hours
Concentration Area 3 <i>Biology, chemistry, geology, physics, or mathematics courses (above 110)</i>	8 Hours
Computer Science Elective	4 Hours
Arts and Sciences Requirements (As listed on page 65.) (NOTE: Students may doublecount 10 hours toward their science major.)	37 Hours
Professional Education Requirements (As listed on page 65.)	45 Hours
Total Hours Required for Bachelor of Science Degree in Natural Science and Elementary Education Certification	196 Hours

¹ General electives may be selected from a variety of disciplines; for example additional hours in biology, geology, computer science, or other disciplines may be appropriate.

Example 2 (actual program may vary)

Bachelor of Science in Natural Science with concentration in biology and certification in elementary education

General Education Core (As listed on page 62.)	50 Hours
Concentration 1 in biology BIOL 151, 202, 203, 303, 307, 330, 340, 350, 485	36 Hours
Concentration 2 in geology GEOL 111, 112, 201, 202	16 Hours
Concentration 3 in chemistry CHEM 121, 122	8 Hours
Mathematics Electives MATH 120, 121	10 Hours
Computer Science Elective AISM 101	4 Hours
Humanities/Social Science Electives ARTS 201, 202, MUSI 160, 161, SPCH 103, PSYC 375	24 Hours
General Electives/Professional Education EDUC 110, 210, 220, 230, 240, 310, 320, 340, 420, 450, HPER 202, 270	53 Hours

Certificate Programs and Minors in Science

Certificate in Environmental Science, BS Degree¹

A certificate in environmental science offers students enrolled in the Bachelor of Science in Natural Science an opportunity to focus their study in basic and environmental sciences. The certificate requires a set of thirteen science and environmental courses, Concentration 1 in either biology or chemistry, and an environmentally related senior project. Many students selecting this option also complete an internship to gain experience working in an environmentally related job.

Required Courses

54 Hours

BIOL 202 Principles of Plant Biology, BIOL 330 Ecology, CHEM 141, 142, and 143 General Chemistry 1-3, CHEM 223 Quantitative Analysis, GEOG 311 Geography of Air Pollution, GEOL 112 Environmental Geology, GEOL 201 Physical Geology, MATH 201 Calculus I, MATH 250 Statistics I, NTSC 240 Introduction to Environmental Science, and PHYS 203 Physics of Energy

For additional information about the environmental science certificate, write or call: Environmental Science Coordinator, Natural Science Department, (614) 355-2301.

Environmental Science Minor¹

A minor in environmental science offers students enrolled in any of Shawnee State University's baccalaureate programs an opportunity to broaden their major course of study with an auxiliary focus in basic and environmental sciences. The

¹ Pending approval.

minor requires six courses (23-28 credit hours) from at least three departments. The minor in environmental science is designed for students in degree programs other than natural science. Natural science students desiring an environmental emphasis should consider the certificate in environmental science.

Required Courses

16-17 Hours

One course in biology (BIOL 151 or another introductory course)
One course in chemistry (CHEM 121 or CHEM 141)
NTSC 240 Introduction to Environmental Science
GEOL 112 Environmental Geology

Elected Courses

7-8 Hours

Two additional courses from the following list:

BIOL 202 Principles of Plant Biology, BIOL 203 Principles of Animal Biology, BIOL 210 Taxonomy of Vascular Plants, BIOL 271 Field Ornithology, BIOL 272 Ohio's Natural Heritage, BIOL 302 Dendrology, BIOL 303 Spring Flora, BIOL 307 General Entomology, BIOL 330 Ecology, BIOL 331 Advanced Field Biology, BIOL 350 Microbiology, BIOL 365 Phycology, BIOL 370 Marine Biology, CHEM 122 Introduction to General Chemistry 2, CHEM 142 General Chemistry 2, CHEM 200 Introduction to Organic Chemistry, GEOG 311 Geography of Air Pollution, GEOL 201 Physical Geology, GEOL 202 Historical Geology, GOVT 401 State of the World, PHIL 202 Environmental Ethics

Associate Degree Programs

Associate of Science Degree: Natural Science Concentration

Shawnee State University offers an associate of science degree for those students desiring two years of general education with an emphasis in science and mathematics. The total number of hours needed to complete the degree is 90.

Curriculum

I. Core Requirements

A. Communications — 12 hours minimum

ENGL 111S Discourse and Composition (4); ENGL 112S Composition and Research (4); ENGL 115S Composition and Literature (4)

Students may take additional courses from the following (optional): ENGL 232 (3); ENGL 240 (3); ENGL 245 (3)

B. Mathematics — 8 hours minimum

MATH 110S Mathematics Core Course (4)

and one additional course from the following: MATH 131 (4); MATH 132 (4); MATH 201 (4); MATH 202 (4); MATH 250 (4); MATH 255 (4)

C. Arts/Humanities — 12 hours minimum (choose from two areas)

ENGL/HIST 225S Civilization and Literature (4)

and two of the following: ARTS 261 (4); ARTS 262 (4); ENGL 200 (4); MUSI 220 (3); PHIL 101 (4)
Students may take additional courses from the following (optional): ENGL 203 (4); ENGL 210 (4); ENGL 211 (4); ENGL 212 (4); MUSI 221 (3); MUSI 222 (3); MUSI 223 (3); PHIL 102 (4); PHIL 103 (4); PHIL 105 (4)

D. Social and Behavioral Sciences — 12 hours minimum (choose from two areas)

SOCI 110S Foundations of Social Science (4); ENGL/HIST 226S Civilization and Literature 2 (4)
and one of the following: ECON 101 (4); GEOG 125 (4); GOVT 101 (4); HIST 111 (4); HIST 112 (4); HIST 113 (4); PSYC 101 (4); SOCI 101 (4)

Students may take additional courses from the following (optional):

ANTH 101 (4); ANTH 250 (4); ECON 102 (4); GOVT 102 (4); GOVT 120 (4); GOVT 250 (4); HIST 201 (4); HIST 202 (4); HIST 203 (4); PSYC 151 (4); PSYC 273 (4); SOCI 201 (4); SOCI 205 (4)

E.¹ Natural Sciences/Physical Sciences — 16 hours minimum

BIOL 110S Life Sciences Core Course (4); PSCI 110S Physical Science Core Course (4)

Select two or more courses from the following: BIOL 151 (5) (3 lec./4 lab); CHEM 121 (4); CHEM 122 (4); CHEM 141 (4); CHEM 142 (4); CHEM 143 (4) (all CHEM - 3 lec./3 lab); GEOL 101 (4) (3 lec./2 lab); PHYS 201 (4); PHYS 202 (4); PHYS 203 (4) (all PHYS - 3 lec./3 lab)

Students may take additional courses from the following (optional): BIOL 162 (5); BIOL 170 (4); BIOL 202 (5); BIOL 203 (6); CHEM 200 (4); CHEM 201 (4); GEOL 112 (4); PHYS 210 (4)

II. Concentration Area — 30 hours

Selected courses in an area of specialization chosen from the following subject areas complete the associate of science degree.

Life Sciences

Mathematics

Physical Sciences

Associate of Individualized Studies Degree

The associate of individualized studies degree (AIS) at Shawnee State University is designed to allow students the option of formulating their own individualized program of study. The philosophical basis of the degree is predicated upon the assumption that students may be unable to achieve their personal educational goals through one of the more formalized two-year degree structures offered at Shawnee State. This is especially true for students interested in concentrating or combining a selected mixture of courses encompassing both academic as well as technical offerings in a manner which may not meet the degree requirements of Shawnee State's associate of arts, associate of applied science, or associate of applied business degrees. Students desiring more information concerning this degree should contact the registrar.



Photo by Associate Professor David E. Todd

1993-1995
Shawnee State University

¹ Students cannot receive credit for both CHEM 121/122 and CHEM 141/142 series.

Department of Social Sciences

Mission

The purpose of the Department of Social Sciences is to provide general education students a sense of the importance of cultural influences, a sense of history within the scope of changing cultural themes, and a sense of their own worth as human beings. These understandings are refined through a sound curriculum in the behavioral sciences, which explains variations in human behavior based on theoretical models, instruction in research methods used by contemporary social scientists, and a special focus on interdisciplinary connections among topical social issues.

Bachelor of Arts Degree with a Major in Social Science

The general social science major requires a fundamental core of social science courses consisting of 36 hours. Students must achieve a minimum grade of "C" in each required social science course in order to graduate.

Degree Requirements

General Education Core (<i>As listed on page 62.</i>)	50 Hours
Social Science Core Courses	36 Hours
Upper Division Social Science Electives (<i>300-400 level</i>)	36 Hours
University Electives	64 Hours
Total Hours Required for Bachelor of Arts Degree with Major in Social Science	186 Hours

Social Science Core Courses (36 Hours)

Course No.	Course	Credit Hours
PSYC 101	Introduction to Psychology	4
SOCI 101	Introduction to Sociology	4
GOVT 250	Introduction to Political Science	4
ECON 101	Principles of Economics 1 (or ECON 102)	4
ANTH 250	Principles of Cultural Anthropology (or GEOG 125 or GEOG 130 or GEOG 201)	4
HIST 111	American History (or HIST 112 or HIST 113)	4
HIST 201	Ancient or European History (or HIST 202 or HIST 203)	4
PSYC 273	Psychology of Human Adjustment	4
GOVT 401	State of the World	4

University Electives (64 Hours)

Although the electives may be chosen from the broad spectrum of university courses, students may choose to take their electives within the social science department (anthropology, geography, history, political science, psychology, and sociology) and pursue a broad emphasis in social science. With this approach, students acquire a comprehensive background in the social sciences. It is suggested that students take 8 to 12 hours from each of the following areas:

- History
- Government
- Economics
- Psychology
- Geography
- Sociology/Anthropology

Faculty are developing programs in the social sciences which involve majors, minors, and concentrations in more specialized areas in the social sciences. Please consult with your advisor or department chairperson to see which programs are offered.

Social Science Major with Elementary Education Certification

Students majoring in social science who wish to complete requirements toward certification in elementary education may choose a special program which was designed to meet their needs. In this curriculum, social science majors take courses which cover subject matter traditionally taught as social studies in the elementary school. Students must achieve a minimum grade of "C" in each required social science course in order to graduate.

Students choosing elementary education certification are urged to work closely with their social science advisor and with an advisor from the elementary education program.

Degree Requirements

General Education Core (As listed on page 62.)	50 Hours
Social Science Requirements	60 Hours
Arts and Sciences Requirements (As listed on page 65.)	37 Hours
Professional Education Requirements (As listed on page 65.)	45 Hours

Total Hours Required for Bachelor of Arts Degree with Major in Social Science and Elementary Education Certification

192 Hours

Social Science Requirements (60 Hours)

Course No.	Course	Credit Hours
SOCI 101	Introduction to Sociology	4
PSYC 101	Introduction to Psychology	4
HIST 111	American History to 1828	4
HIST 112	American History, 1828-1900	4
HIST 113	American History Since 1900	4
PSYC 273	Psychology of Human Adjustment	4
HIST 201	Ancient History (or HIST 202 or HIST 203)	4
GEOG 125	World Geography (or GEOG 201 or GEOG 225)	4
ECON 101	Principles of Economics 1 (or ECON 102)	4
GOVT 250	Introduction to Political Science	4
PSYC 310	Child Psychology (or PSYC 316)	4
SOCI 310	Gender Socialization	4
GOVT 401	State of the World	4
	Social Science Electives	8

Bachelor of Arts Degree in Social Sciences: 2+2 for Students Who Complete the Legal Assisting Program

This program is designed for students who have completed the associate degree in legal assisting at Shawnee State and who wish to pursue a baccalaureate degree as preparation for law school. All required courses in the Legal Assisting Program (98 quarter hours) count toward the baccalaureate requirements. For the B.A., students need to complete an additional 34 hours of General Education Core Requirements, 28 hours of Social Science Core Requirements, and 32 hours in social

science at the 300-400 level. The entire program requires completion of 192 quarter hours. Students must achieve a minimum grade of "C" in each required social science course in order to graduate.

Degree Requirements

Completion of the Legal Assisting Program	98 Hours
Additional General Education Core	34 Hours
Additional Social Science Core Courses	28 Hours
Upper Division Social Science Electives (300-400 level)	32 Hours
Total Hours Required for Bachelor of Arts Degree with Major in Social Science (Legal Assisting 2+2)	192 Hours

Legal Assisting Curriculum (98 Hours)

Includes certain courses that are part of either the General Education Core or the Social Science Core (refer to page 87 of this catalog).

Additional General Education Core (34 Hours)

Course No.	Course	Credit Hours
ENGL 115S	Composition and Literature	4
ENGL/HIST 225S	Civilization and Literature 1	4
ENGL/HIST 226S	Civilization and Literature 2	4
ENGL/HIST 227S	Civilization and Literature 3	4
PSCI 110S	Physical Science Core Course	4
BIOL 110S	Life Sciences Core Course	4
MATH 110S	Mathematics Core Course	4
SOCI 485S	Community Involvement	2
SOCI 490S	Senior Seminar	4

Additional Social Science Core (28 Hours)

Course No.	Course	Credit Hours
SOCI 101	Introduction to Sociology	4
ECON 101	Principles of Economics 1 (or ECON 102)	4
HIST 111	American History (or HIST 112 or 113)	4
HIST 201	Ancient or European History (or HIST 202 or 203)	4
PSYC 273	Human Adjustment	4
GEOG 125	World Geography (or GEOG 130 or 201 or ANTH 250)	4
GOVT 401	State of the World	4

Upper Division Social Science Electives (32 Hours)

Student selects 32 quarter hours of upper division social science electives (courses in anthropology, economics, geography, government, history, psychology, and/or sociology) in consultation with his or her faculty advisor.

Associate Degree Programs

Associate of Arts Degree: Social Science Concentration

Shawnee State University offers an associate of arts degree for those students wishing to complete a two-year program of general education with an emphasis in the social sciences. The total number of hours needed to complete the degree is 90. Students must achieve a minimum grade of "C" in each required social science course in order to graduate.



Curriculum

I. Core Requirements

A. Composition — 12 hours minimum

ENGL 111S Discourse and Composition (4); ENGL 112S Composition and Research (4); ENGL 115S Composition and Literature (4)

Students may take additional courses from the following (optional): ENGL 232 (3); ENGL 240 (3); ENGL 245 (3)

B. Mathematics — 4 hours minimum

MATH 110S Mathematics Core Course (4)

Students may choose additional mathematics courses from the following (optional): MATH 131 (4); MATH 132 (4); MATH 201 (4); MATH 202 (4); MATH 250 (4); MATH 255 (4)

C. Arts and Humanities — 16 hours minimum (choose from two areas)

ENGL/HIST 225S Civilization and Literature (4)

and two courses from the following: ARTS 262 (4); ARTS 261 (4); ENGL 200 (4); MUSI 220 (3); PHIL 101 (4)

and one course from the following: Art, English, Humanities, Journalism, Language, Music, Philosophy, or Theatre

Students may choose additional courses from the following (optional): ENGL 203 (4); ENGL 210 (4); ENGL 211 (4); ENGL 212 (4); MUSI 221 (3); MUSI 222 (3); MUSI 223 (3); PHIL 102 (4); PHIL 103 (4); PHIL 105 (4)

D. Social Science — 16 hours minimum (choose from two areas)

SOCI 110S Foundations of Social Science (4); HIST/ENGL 226S Civilization and Literature 2 (4); SOCI 101 Introduction to Sociology (4); or PSYC 101 Introduction to Psychology (4)

and one course from the following: ECON 101 (4); GEOG 125 (4); GOVT 101 (4); HIST 111 (4); HIST 112 (4); HIST 113 (4); PSYC 101 (4); SOCI 101 (4)

Students may choose additional courses from the following (optional): ANTH 101 (4); ANTH 250 (4); ECON 102 (4); GOVT 102 (4); GOVT 120 (4); GOVT 250 (4); HIST 201 (4); HIST 202 (4); HIST 203 (4); PSYC 151 (4); PSYC 273 (4); SOCI 201 (4); SOCI 205 (4)

E. Natural Sciences — 12 hours minimum

BIOL 110S Life Sciences Core Course (4); PSCI 110S Physical Science Core Course (4)

and one or more of the following: BIOL 151 (5) (3 lec./4 lab); CHEM 121 (4); CHEM 122 (4); CHEM 141 (4); CHEM 142 (4); CHEM 143 (4) (all CHEM - 3 lec./3 lab); PHYS 201 (4); PHYS 202 (4); PHYS 203 (4) (all PHYS - 3 lec./3 lab); GEOL 101 (4) (3 lec./2 lab)

Students may choose additional courses from the following (optional): BIOL 162 (5); BIOL 170 (4); BIOL 202 (5); BIOL 203 (6); CHEM 200 (4); CHEM 201 (4); GEOL 112 (4); PHYS 210 (4)

Note: Students cannot receive credit for both CHEM 121/122 and CHEM 141/142 series.

II. Concentration Area — 30 hours

A. Arts

Selected courses in an area of specialization chosen from the following list of humanities subject areas to complete the associate of arts degree.

Art	Humanities	Music
Comparative Arts	Journalism	Philosophy
English	Language	Theatre

B. Social Sciences

Selected courses in an area of specialization chosen from the following list of subject areas to complete the associate of arts degree:

Anthropology	Government	Psychology
Economics	History	Sociology
Geography		

Associate of Individualized Studies Degree

The associate of individualized studies degree (AIS) at Shawnee State University is designed to allow students the option of formulating their own individualized program of study. The philosophical basis of the degree is predicated upon

College of
Arts and
Sciences

the assumption that students may be unable to achieve their personal educational goals through one of the more formalized two-year degree structures offered at Shawnee State. This is especially true for students interested in concentrating or combining a selected mixture of courses encompassing both academic as well as technical offerings in a manner which may not meet the degree requirements of Shawnee State's associate of arts, associate of applied science, or associate of applied business degrees. Students desiring more information concerning this degree should contact the registrar.





College of
Business



1993-1995
Shawnee State University

81

Mission of the College of Business

The mission (purpose) of the College of Business is to prepare individuals for productive and satisfying professional careers in business. The College of Business seeks to develop in students, a continuing intellectual curiosity, an awareness of individual and cultural diversity, and a high degree of professional competence. To this end, the College of Business encourages an integrated general education in the arts and sciences, provides a body of knowledge common to all areas of business, and provides a systematic body of specialized knowledge and skills applicable to specific business disciplines.

To meet the diverse needs of students and businesses, the College of Business offers programs at the associate level, stressing applied entry-level skills, and at the baccalaureate level, stressing broader theoretical concepts and leadership skills applicable to more complex organizational problems.

Degrees Offered by the College of Business

Bachelor of Science

Business Administration

Associate of Applied Business

Accounting/Professional

Accounting/Management

Business Management/Management

Business Management/Banking and Finance

Business Management/Real Estate

Business Management/Retail Management

Business Management/Small Business¹

Computer Information Systems in Business

Legal Assisting

Office Administration/Executive

Office Administration/General

Bachelor of Science in Business Administration With a Major in General Business

The four-year program in general business is designed to provide students with a broad understanding of business. The program focuses on the dynamics of business in all aspects. A broad-based general education precedes an extensive education in general business. A successful graduate has the necessary tools to enter into a career in business as well as to pursue graduate studies.

The general business program has both a core of business courses and non-business courses. Students choose, by consultation with their advisors, at least one upper division course in four of the six prescribed elective areas: accounting, automated information systems, economics, finance, management, and marketing. Students have some flexibility to design a program to meet their career goals.

Degree Requirements

General Education Core	50 Hours
Business Core Courses	68 Hours
Upper Division Electives	16 Hours

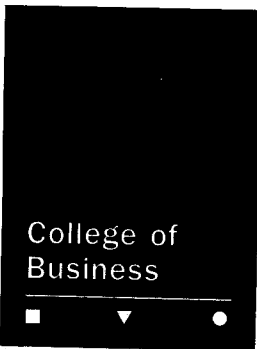

Degree Requirements (cont'd.)

Other Business Electives	20 Hours
Non-Business Electives	24 Hours
Business or Non-Business Electives	8 Hours

**Total Hours Required for
Bachelor of Science in Business Administration** **186 Hours**

Students must take a minimum of 74 hours of non-business courses (General Education Core and Non-Business Electives). Two hours of non-business courses may be in physical education.

Note: A maximum of 52 hours may be accepted as transfer credit to fulfill the credit hours required as the business core. Sixteen hours of upper division elective courses required for the general business concentration must be completed at Shawnee State University.

General Education Core (50 Hours)

Course No.	Course	Credit Hours
ENGL 111S	Discourse and Composition	4
ENGL 112S	Composition and Research	4
ENGL 115S	Composition and Literature	4
ENGL/HIST 225S	Civilization and Literature 1	4
ENGL/HIST 226S	Civilization and Literature 2	4
ENGL/HIST 227S	Civilization and Literature 3	4
PSCI 110S	Physical Science Core Course	4
SOCI 110S	Foundations of Social Science	4
BIOL 110S	Life Sciences Core Course	4
MATH 110S	Mathematics Core Course	4
PHIL 320S	Ethics in Public and Private Life	4
BADM 485S	Community Involvement	2
BADM 490S	Senior Seminar	4

Business Core Courses (68 Hours)

Course No.	Course	Credit Hours
ACCT 201	Financial Accounting Principles	4
ACCT 203	Managerial Accounting	4
AIMS 101	Introduction to Automated Information Systems	4
AIMS 103	Computer Applications	4
BUSL 270	Legal Environment of Business	4
ECON 101	Principles of Economics 1	4
ECON 102	Principles of Economics 2	4
FINA 345	Managerial Finance	4
MATH 201	Calculus	4
MATH 250	Statistics 1	4
MGNT 310	Management Principles	4
MGNT 330	Organizational Communication	4
MGNT 340	International Business	4
MGNT 355	Quantitative Methods in Business	4
MGNT 385	Production/Operations Management	4
MGNT 485	Business Policy/Strategy	4
MRKT 310	Marketing Principles	4

Upper Division Electives (16 Hours)

Choose at least one upper division (300-400 level) course from four of the following areas.

Accounting	Finance
Automated Information Systems	Management
Economics (See FINA 310 cross-listing)	Marketing

1993-1995
Shawnee State University

Other Business Electives (20 Hours)

These electives must include at least 20 hours of additional business courses. They may be 100-400 level.

Non-Business Electives (24 Hours)

Business or Non-Business Electives (8 Hours)

Note: Special Topics in Business Courses (299, 399, and 499)

1. A formal review and a subsequent written approval by a College of Business review committee is mandatory before credit is given for any special topics course. This review committee is made up of one member from each of the instructional areas. This applies to all students.
2. A student can accumulate a total of twelve credit hours in the College of Business using special topics courses.
3. Special topics courses apply for credit toward electives only and not toward required courses.
4. A faculty member does not have to teach a special topics course. It is the faculty member's option.

Special Note: Most business administration courses are offered in both the day and evening sections. See your advisor.

Business Administration Curriculum (Sample Schedule)

The following is a suggested outline of curriculum, by quarters, for the Bachelor of Science degree in Business Administration.

Course No.	Course	Class Hours	Lab Hours	Credit Hours
FIRST QUARTER				
AIMS 101	Intro. to Automated Information Systems ¹	4	0	4
ECON 101	Principles of Economics 1	4	0	4
ENGL 111S	Discourse and Composition	4	0	4
	Business Elective ²	4	0	4
	Totals	16	0	16
SECOND QUARTER				
AIMS 103	Computer Applications	4	0	4
ECON 102	Principles of Economics 2	4	0	4
ENGL 112S	Composition and Research	4	0	4
MATH ³	Mathematics Sequence	4	0	4
	Totals	16	0	16
THIRD QUARTER				
BIOL 110S	Life Sciences Core Course	4	0	4
ENGL 115S	Composition and Literature	4	0	4
MATH ³	Mathematics Sequence	4	0	4
SOCI 110S	Foundations of Social Science	4	0	4
	Totals	16	0	16

¹ CISB 101 may be substituted for this course.

² Suggested courses are BMNT 101 or BMNT 201.

³ The mathematics sequence for the degree in business administration includes MATH 099, MATH 101, MATH 105, MATH 110S, MATH 130, MATH 131, MATH 201, MATH 250, MGNT 355, and MGNT 385. Students are not necessarily required to take all of these courses. Upon entrance to Shawnee State University, students are evaluated to see at what level of mathematics they should begin. This evaluation determines the starting point — courses earlier in the mathematics sequence may be bypassed. All courses higher in number are required. The courses in this sequence should be taken one at a time. Since there are a maximum of 10 courses and a student may be able to graduate in 12 quarters, most students should be enrolled in a mathematics course almost every quarter.

FOURTH QUARTER				
ACCT 201	Financial Accounting Principles	4	0	4
BUSL 270	The Legal Environment of Business	4	0	4
ENGL 225S	Civilization and Literature 1	4	0	4
MATH ¹	Mathematics Sequence	4	0	4
	Totals	16	0	16
FIFTH QUARTER				
ACCT 203	Managerial Accounting	4	0	4
ENGL 226S	Civilization and Literature 2	4	0	4
MATH ¹	Mathematics Sequence	4	0	4
	Business Elective ²	4	0	4
	Totals	16	0	16
SIXTH QUARTER				
ENGL 227S	Civilization and Literature 3	4	0	4
MATH ¹	Mathematics Sequence	4	0	4
PSCI 110S	Physical Science Core Course	4	0	4
	Business or Non Business Elective ³	4	0	4
	Totals	16	0	16
SEVENTH QUARTER				
MATH ¹	Mathematics Sequence/Non-Business Elective	4	0	4
MGNT 310	Management Principles	4	0	4
MGNT 340	International Business	4	0	4
	Upper Division Business Elective ⁴	4	0	4
	Totals	16	0	16
EIGHTH QUARTER				
MATH ¹	Mathematics Sequence/Non-Business Elective	4	0	4
MRKT 310	Marketing Principles	4	0	4
PHIL 320S	Ethics in Public and Private Life	4	0	4
	Business or Non-Business Elective ³	4	0	4
	Totals	16	0	16
NINTH QUARTER				
MATH ¹	Mathematics Sequence/Non-Business Elective	4	0	4
MGNT 330	Organizational Communications	4	0	4
	Business or Non-Business Elective ³	4	0	4
	Upper Division Business Elective ⁴	4	0	4
	Totals	16	0	16
TENTH QUARTER				
FINA 345	Managerial Finance	4	0	4
MGNT 355	Quantitative Methods in Business	4	0	4

¹ The mathematics sequence for the degree in business administration includes MATH 099, MATH 101, MATH 105, MATH 110S, MATH 130, MATH 131, MATH 201, MATH 250, MGNT 355, and MGNT 385. Students are not necessarily required to take all of these courses. Upon entrance to Shawnee State University, students are evaluated to see at what level of mathematics they should begin. This evaluation determines the starting point — courses earlier in the mathematics sequence may be bypassed. All courses higher in number are required. The courses in this sequence should be taken one at a time. Since there are a maximum of 10 courses and a student may be able to graduate in 12 quarters, most students should be enrolled in a mathematics course almost every quarter. Students should take their non-business electives when they finish the mathematics sequence.

² Suggested courses are BMNT 101 or BMNT 201, other business electives must be at least 20 hours.

³ Two hours of non-business electives may be in physical education. Student must take additional 6-8 hours of non-business courses.

⁴ Students must choose one upper division course from any four of the following for 16 credit hours: **ACCOUNTING:** ACCT 305 Governmental Accounting, ACCT 330 Industrial Accounting, ACCT 360 Systems Accounting, ACCT 410 Health Care Accounting, and ACCT 435 Auditing; **MANAGEMENT:** BAMN 331 Business Ethics, MGNT 312 Purchasing and Materials Management, MGNT 320 Data Analysis, MGNT 332 Managerial Economics, MGNT 335 Human Resource Management, MGNT 340 International Business, MGNT 350 Organizational Behavior, MGNT 405 Forecasting Business Trends, MGNT 410 Simulation, and MGNT 480 Business and Society; **ECONOMICS:** ECON 301 Intermediate Microeconomics, ECON/FINA 310 Money and Banking, ECON 325 Economic History of the U.S., ECON 332 Managerial Economics, and ECON 411 Comparative Economic Systems; **AUTOMATED INFORMATION SYSTEMS:** AISM 310 Data Base Management, AISM 320 Systems Analysis and Design, and AISM 430 Information Systems Development Project; **FINANCE:** FINA 301 Principles of Insurance, FINA 304 Investments, FINA 310 Money and Banking, FINA 311 Financial Statement Analysis, FINA 315 Financial Institutions, and FINA 481 International Finance; and **MARKETING:** MRKT 315 International Marketing, MRKT 320 Sales Management, MRKT 325 Marketing Research, MRKT 400 Marketing Management.

	TENTH QUARTER (cont'd.)			
	Business or Non-Business Elective ¹	4	0	4
	Upper Division Business Elective ²	4	0	4
	Totals	16	0	16
	ELEVENTH QUARTER			
BADM 485S	Community Involvement	2	0	2
MGNT 385	Production/Operations Management	4	0	4
	Business or Non-Business Elective ¹	4	0	4
	Upper Division Business Elective ²	4	0	4
	Totals	14	0	14
	TWELFTH QUARTER			
BADM 490S	Senior Seminar	4	0	4
MGNT 485	Business Policy and Strategy	4	0	4
	Business or Non-Business Elective ¹	4	0	4
	Totals	12	0	12
	TOTAL HOURS			186

IMPORTANT: Any student having earned credit for an upper-level course cannot subsequently apply credit for a lower-level sequence course toward graduation. Example: A student who earned credit for MGNT 310 could not subsequently take BMNT 101, 201, or 202 and apply the lower-level course credits toward graduation. This notice is applicable, but not limited, to BAFT 204, BMNT 101, BMNT 201, BMNT 202, and FINA 201.

Associate Degree in Applied Business

Our associate degree programs have two main goals: to prepare students for the job market and to give students the necessary foundation to advance, if they choose, to the bachelor of science degree program.

There are five main areas of study:

- Accounting Technology
- Business Management Technology
- Computer Information Systems in Business
- Legal Assisting Technology
- Office Administration Technology

Accounting Technology

The field of accounting offers many career opportunities in both the private and public sector.

¹ Two hours of non-business electives may be in physical education. Student must take additional 6-8 hours of non-business courses.

² Students must choose one upper division course from any four of the following for 16 credit hours: **ACCOUNTING:** ACCT 305 Governmental Accounting, ACCT 330 Industrial Accounting, ACCT 360 Systems Accounting, ACCT 410 Health Care Accounting, and ACCT 435 Auditing; **MANAGEMENT:** BAMN 331 Business Ethics, MGNT 312 Purchasing and Materials Management, MGNT 320 Data Analysis, MGNT 332 Managerial Economics, MGNT 335 Human Resource Management, MGNT 340 International Business, MGNT 350 Organizational Behavior, MGNT 405 Forecasting Business Trends, MGNT 410 Simulation, and MGNT 480 Business and Society; **ECONOMICS:** ECON 301 Intermediate Microeconomics, ECON/FINA 310 Money and Banking, ECON 325 Economic History of the U.S., ECON 332 Managerial Economics, and ECON 411 Comparative Economic Systems; **AUTOMATED INFORMATION SYSTEMS:** AISM 310 Data Base Management, AISM 320 Systems Analysis and Design, and AISM 430 Information Systems Development Project; **FINANCE:** FINA 301 Principles of Insurance, FINA 304 Investments, FINA 310 Money and Banking, FINA 311 Financial Statement Analysis, FINA 315 Financial Institutions, and FINA 481 International Finance; and **MARKETING:** MRKT 315 International Marketing, MRKT 320 Sales Management, MRKT 325 Marketing Research, MRKT 400 Marketing Management.

Management (Industrial) Accounting

The management accountant is trained to determine the financial consequences of management decisions. The reports and analyses of the management accountant are essential ingredients of most management decisions about finance, investments, and pricing policies. More than anyone else on the management team, the management accountant participates in virtually every phase of the business problem solving and decision making process. Because of the accountant's role in this process, he or she has many times advanced to a top management position within the company.

Governmental Accounting

All organizations need accounting information. Government and other non-profit organizations are no exception. The federal government hires accountants in most of its agencies. Three prominent agencies are the Internal Revenue Service, the General Accounting Office, and the Defense Contract Audit Agency. State and local government units hire accountants in their tax divisions and in general accounting functions. Schools and hospitals are major users of accounting services. Many opportunities exist for those interested in governmental accounting.

Public Accounting and the CPA

For the protection of the public, the CPA is expected to possess certain professional qualifications. The Uniform CPA Examination is designed to measure the technical competency, the exercise of good judgement, and the understanding of professional responsibility of each man or woman who chooses this career in accounting. The public accountant is a true independent professional person with the stature of a doctor or lawyer. In public accounting many opportunities exist for professional growth, whether one practices as a sole practitioner or as part of a larger firm.

Special Note: Most of the accounting courses are offered in both the day and evening sections. See your advisor.

Accounting Curriculum (Sample Schedule)

Course No.	Course	Credit Hours
FIRST QUARTER		
ACCT 101	Accounting 1	4
BMNT 101	Introduction to Business	4
ENGL 111S	Discourse and Composition	4
CISB 101	Introduction to Computer Information Systems	4
	Total	16
SECOND QUARTER		
ACCT 102	Accounting 2	4
BMNT 201 ²	Management Concepts (<i>see advisor</i>)	4
ECON 101	Principles of Economics 1	4
ENGL 112S	Composition and Research	4
MATH ¹	Mathematics (<i>see advisor</i>)	4
	Total	20
THIRD QUARTER		
ACCT 103	Accounting 3	4
ACCT 110	Payroll Records/Accounting	3

¹ Students with adequate mathematics background, as determined by placement testing, should elect MATH 110S or MATH 130 if intending to pursue baccalaureate degree.

² Students pursuing BSBA degree may substitute MGNT 310.

THIRD QUARTER (cont'd.)

ECON 102	Principles of Economics 2	4
ENGL 115S	Composition and Literature	4
MATH ¹	Mathematics (see <i>advisor</i>)	4
	Total	19

SECOND YEAR CURRICULUM: Accounting/Professional Emphasis

FOURTH QUARTER		
ACCT 211	Intermediate Accounting 1	4
ACCT 221	Cost Accounting 1	4
BUSL 250 ²	Business Law 1	4
CISB/AISM	Elective	4
FINA 201	Principles of Finance	20
	Total	
FIFTH QUARTER		
ACCT 212	Intermediate Accounting 2	4
ACCT 222	Cost Accounting 2	4
BMNT 242 ³	Business Communications	4
SOCI/PSYC	Elective	3
SPCH 103	Public Speaking and Human Communication	19
	Total	
SIXTH QUARTER		
ACCT 213	Intermediate Accounting 3	4
ACCT	Elective	3-4
BMNT 202 ⁴	Personnel Management	4
SOCI/PSYC	Elective	4
	Total	15-16

SECOND YEAR CURRICULUM: Accounting/Management Emphasis

FOURTH QUARTER		
ACCT 211	Intermediate Accounting 1	4
ACCT 221	Cost Accounting 1	4
BUSL 250	Business Law 1	4
CISB/AISM	Elective	4
FINA 201	Principles of Finance	4
	Total	20
FIFTH QUARTER		
ACCT 222	Cost Accounting 2	4
BUSL 260	Business Law 2	4
SOCI/PSYC	Elective	4
SPCH 103	Public Speaking and Human Communication	3
	Business Elective	4
	Total	19
SIXTH QUARTER		
ACCT	Elective	3-4
ACCT 215	Tax Accounting	4
BMNT 202 ³	Personnel Management	4
SOCI/PSYC	Elective	4
	Total	15-16

Note: Minimum total hours required for associate degree in accounting is 104.

¹ Students with adequate mathematics background, as determined by placement testing, should elect MATH 110S or MATH 130 if intending to pursue baccalaureate degree.
² Students pursuing BSBA degree may substitute BUSL 270.
³ Students pursuing BSBA degree may substitute MGNT 330.
⁴ Students pursuing BSBA degree may substitute MGNT 335.

Business Management Technology with Majors in Retail Management, Banking/Finance, Business Management, Real Estate, and Small Business¹

College of
Business

The Associate Degree in Business Management

The Associate Degree in Business Management is designed to provide the student with the knowledge, understanding, and skills required for entry-level management positions. The successful student is provided access to a career path leading to a variety of challenging and rewarding middle-management positions in business, service organizations, industry, and financial institutions.

The business management curriculum provides 32 hours of technical electives. **Students MUST choose a minimum of 20 credit hours within one of the five¹ specialized areas shown on the following pages as their area of emphasis.** The remaining 12 technical electives are chosen from the list of approved technical electives. This provides the student the opportunity to design a program compatible with individualized interest and career goals.

Special Note: Most business management courses are offered in both the day and evening sections. See your advisor.

Business Management Curriculum (Sample Schedule)

Course No.	Course	Class Hours	Lab Hours	Credit Hours
FIRST QUARTER				
ACCT 101	Accounting 1	3	4	4
BMNT 101	Introduction to Business	4	0	4
ENGL 111S	Discourse and Composition	4	0	4
MATH 101	Basic Algebra	4	0	4
²	Technical Elective	4	0	4
	Totals	19	4	20
SECOND QUARTER				
ACCT 102	Accounting 2	3	4	4
BMNT 102	Marketing Concepts	4	0	4
ENGL 112S	Composition and Research	4	0	4
MATH 125	Business Mathematics	4	0	4
	Totals	15	4	16
THIRD QUARTER				
CISB 101	Introduction to Computer Information Systems	4	0	4
ENGL 115S	Composition and Literature	4	0	4
²	Technical Electives	12	0	12
	Totals	20	0	20
FOURTH QUARTER				
BUSL 250	Business Law 1	4	0	4
ECON 101	Principles of Economics 1	4	0	4
PSYC 101	Introduction to Psychology	4	0	4
²	Technical Elective	4	0	4
	Totals	16	0	16
FIFTH QUARTER				
BMNT 201	Management Concepts	4	0	4
BUSL 260	Business Law 2	4	0	4

¹ Pending approval by the Ohio Board of Regents.

² Approved Technical Electives: OADM 101 Keyboarding 1, OADM 102 Keyboarding 2, OADM 130 Records Management, OADM 221 Word Processing 1, ACCT 103 Accounting 3, ACCT 110 Payroll Accounting, ACCT 215 Tax Accounting, ACCT 221 Cost Accounting 1, CISB 103 BASIC Language, CISB 104 BASIC Language 2, CISB 105 COBOL, CISB 208 RPG, or any BMNT, FINA, RMMT, BAFT, REST, or SBMT course for which the student has the required prerequisite.

1993-1995
Shawnee State University

89

FIFTH QUARTER (cont'd.)				
ECON 102	Principles of Economics 2	4	0	4
SOCI 101	Introduction to Sociology	4	0	4
	Totals	16	0	16
SIXTH QUARTER				
SOCI ¹	Elective	4	0	4
SPCH 103	Public Speaking and Human Communication	3	0	3
	Technical Electives	12	0	12
	Totals	19	0	19

Retail Management Emphasis

Retailing involves all those activities related to the sale of consumer goods to consumers. The retailing segment of our economy provides jobs for about 17% of all employed people. These jobs are in small stores and giant corporate chains in nearly every part of the U.S.

Successful management trainees in retailing can move into a number of challenging jobs. Department manager, assistant buyer or buyer, and sales manager are but a few of the possibilities. **Students choosing retailing as an emphasis in the Business Management program MUST take a minimum of 20 credit hours from the following courses as part of the required technical electives.**

BAFT 105	Installment Credit
RMMT 103	Introduction to Retailing
RMMT 104	Salesmanship
RMMT 223	Retail Buying
RMMT 225	Marketing Case Studies
RMMT 233	Sales Promotion
RMMT 235	Advertising
RMMT 239	Practical Business Applications
RMMT 240	Practical Retail

Banking/Finance Emphasis

The specialization in banking and finance is designed to provide individuals interested in a career in banking, savings and loans, credit unions, or credit departments of retail companies with the basic knowledge and skills required to gain employment and to advance to managerial level occupations. There are a large number of lower and middle level management positions in most financial institutions which a student would be qualified to fill with this specialty and the requisite experience. Some of the managerial positions available in banks are loan officer, trust officer, collections officer, branch manager, and cashier.

The banking and finance curriculum parallels that required by the American Institute of Banking.

Students choosing banking and finance MUST take a minimum of 20 credit hours from the following courses as a part of the technical electives required in the Business Management program.

BAFT 101	Banking and Finance
BAFT 102	Introduction to Commercial Lending
BAFT 105	Installment Credit

¹ Approved Social Science Electives: SOCI 110S Foundations of Social Science, SOCI 205 Current Social Problems, SOCI 210 Women in Society, SOCI 234 Sociology of Aging, PSYC 273 Human Adjustment, PSYC 151 Human Growth and Development, SOCI 224 Urban Sociology.

² Approved Technical Electives: OADM 101 Keyboarding 1, OADM 102 Keyboarding 2, OADM 130 Records Management, OADM 221 Word Processing 1, ACCT 103 Accounting 3, ACCT 110 Payroll Accounting, ACCT 215 Tax Accounting, ACCT 221 Cost Accounting 1, CISB 103 BASIC Language, CISB 104 BASIC Language 2, CISB 105 COBOL, CISB 208 RPG, or any BMNT, FINA, RMMT, BAFT, REST, or SBMT course for which the student has the required prerequisite.

BAFT 106	Principles of Bank Operations
BAFT 202	Home Mortgage Lending
BAFT 204	Introduction to Investments
FINA 201	Principles of Finance
FINA 240	Personal Finance
FINA 301	Principles of Insurance
FINA xxx	Any upper division finance course
REST 213	Real Estate Finance

Business Management Emphasis

The business management option is a general business curriculum appropriate for three types of students.

First, the option provides a general business background for those who want to work in business but haven't decided on a specific career area. With some experience and, perhaps, additional specialized courses, this option can lead into management trainee programs in most types of business and industry.

Second, this option is appropriate for those with a technical degree or background who want to move into managerial positions.

Third, the curriculum provides an excellent business background for individuals who want to operate their own small businesses.

Students choosing business management MUST take a minimum of 20 credit hours from the following courses as part of the required technical electives.

BAFT 105	Installment Credit
BMNT 202	Personnel Management
BMNT 241	Labor Relations
BMNT 242	Business Communication
FINA 201	Principles of Finance
FINA 301	Principles of Insurance
RMMT 225	Marketing Case Studies
RMMT 235	Advertising

Real Estate Emphasis

The real estate specialization of the Business Management program provides the academic preparation for students who have an interest in becoming real estate agents, real estate brokers, appraisers, or managers of real estate firms.

Successful completion of specific courses in the curriculum meets the requirements of Ohio law and qualifies the student to sit for the Real Estate Salesman's and Real Estate Broker's examinations. The curriculum also prepares the student for the Graduate Real Estate Institute examination.

Students whose emphasis is real estate MUST choose a minimum of 20 credit hours from the following courses for the required technical electives.

REST 101	Real Estate Mathematics Applications
REST 210	Real Estate Principles and Practices
REST 212	Real Estate Law
REST 213	Real Estate Finance
REST 214	Real Estate Appraisal
REST 215	Real Estate Brokerage

Real Estate Sales Program: The Ohio Division of Real Estate recognizes Shawnee State as an approved educational institution. Persons wishing to take the Ohio examination for real estate sales license must first complete the following four courses: Real Estate Principles and Practices, Real Estate Law, Real Estate Appraisal, and Real Estate Finance. These courses must be completed within the ten year period

preceding the scheduled examination. Also, individuals born after 1950 must have a high school diploma or its equivalent as recognized by the Ohio Department of Education.

Graduate Realtors' Institute Designation: The purpose of the Graduate Realtors' Institute is:

- To fill the need for a more comprehensive and better instruction program in all facets of the real estate profession through courses of instruction in institutions of higher learning.
- To provide licensed real estate brokers and salesmen an opportunity for enhancement of professional competence and financial success through participation in the Graduate Realtors' Institute (GRI).
- To recognize those who have successfully qualified for the GRI designation by awarding them a certificate and pin which identifies them as GRI members.

Enrollment in the Real Estate program is not limited to candidates for the GRI certificate.

Individuals seeking information about specific facets of the real estate industry may enroll in any course; however, program curriculum is oriented to the educational needs of the professional.

The GRI designation is available to those who hold membership in the Ohio Association of Real Estate Boards and have completed the program requirements. A certificate in recognition of achievement and a GRI lapel pin are awarded to those individuals successfully completing the following: program requirements, application to the Ohio Association of Real Estate Boards, payment of required fees, and a comprehensive examination.

Small Business Management Emphasis¹

Over 90% of all businesses are classified as "small" by the Small Business Administration. This specialization is for those who recognize that entrepreneurs are the lifeblood of our economic system.

Capitalism is developed around risk-taking entrepreneurs, but the spirit and motivation that drive entrepreneurs will not guarantee success in today's competitive world. Individuals must be equipped with the knowledge and skill to operate a small business successfully. The Small Business Management specialization provides the tools needed to be an effective small business manager.

Students choosing small business MUST take a minimum of 20 credit hours from the following courses as part of the required technical electives.

BMNT 202	Personnel Management
BMNT 241	Labor Relations
FINA 240	Personal Finance
FINA 301	Principles of Insurance
RMMT 235	Advertising
SBMT 225	Organization and Operation of Small Business
SBMT 236	Franchising
SBMT 290	Seminar in Small Business Problems

Computer Information Systems in Business

The Computer Information Systems in Business associate degree program at Shawnee State University is designed to meet the manpower demand of industries, government, and educational institutions.

In addition to theoretical fundamentals, practical aspects of computer systems in business are emphasized. Hands-on opportunity is provided and encouraged.

¹ Pending approval by the Ohio Board of Regents.

Graduates of this program are fully prepared to enter employment as computer programmers, operators, or microcomputer specialists in computer installations or application departments. Graduates of this technology receive an associate degree in applied business.

Special Note: Most computer classes are offered in both the day and evening sections. See your advisor.

**Computer Information Systems in Business Curriculum
(Sample Schedule)**

Course No.	Course	Class Hours	Lab Hours	Credit Hours
FIRST QUARTER				
ACCT 101	Accounting 1	3	2	4
CISB 101	Introduction to Computer Information Systems	4	0	4
ENGL 111S	Discourse and Composition	4	0	4
MATH ¹	Mathematics Sequence	4	0	4
OADM 101 ²	Typing 1	3	1	3
	Totals	18	3	19
SECOND QUARTER				
ACCT 102	Accounting 2	3	2	4
AISM 103 or CISB 204	Computer Applications Microcomputer Applications	4	0	4
CISB 103	BASIC Language 1	4	0	4
ENGL 112S	Composition and Research	4	0	4
	Totals	15	2	16
THIRD QUARTER				
ACCT 103	Accounting 3	3	2	4
CISB 201	C Language	4	0	4
ENGL 115S	Composition and Literature	4	0	4
MATH ¹	Mathematics Sequence	4	0	4
	Totals	15	2	16
FOURTH QUARTER				
BUSL 250	Business Law 1	4	0	4
CISB 105	COBOL Programming 1	4	0	4
CISB ³	Elective	3-4	0	3-4
ENGL 121	Technical Writing	3	0	3
PSYC 101	Introduction to Psychology	4	0	4
	Totals	18-19	0	18-19
FIFTH QUARTER				
BMNT 201	Management Concepts	4	0	4
CISB 106	COBOL Programming 2	4	0	4
CISB 203	Business Computer Projects	4	0	4
ECON 101	Principles of Economics 1	4	0	4
	Totals	16	0	16
SIXTH QUARTER				
CISB 208	RPG II Language	4	0	4
CISB ³	Electives (2)	6-8	0	6-8
MATH 150	Principles of Statistics	4	0	4
	Totals	14-16	0	14-16

¹ Mathematics Sequence: Basic Algebra, Business Mathematics, or Plane Geometry and Algebra, College Algebra 1, College Algebra 2, Trigonometry and Analytic Geometry, or Calculus I. Advisor determines mathematics sequence based on placement testing. With advisor approval, students may take any mathematics sequence from the above list as long as they have 8 credit hours.

² Students who have successfully completed at least one-half (1/2) school year of typing at the high school level may omit this requirement.

³ CISB Electives: CISB 104 Basic Language 2, CISB 202 Computer Operations Management, CISB 205 Business Data Systems and Communication, CISB 206 FORTRAN 77, CISB 207 Pascal, CISB 299 Special Topics, AISM 310 Data Base Management, AISM 320 Systems Analysis and Design, OADM 240 Desktop Publishing.

Office Administration Technology

Various positions are available after completion of the Office Administration program. The graduate is qualified to fill a broad range of office positions which require technical skills. All office administration majors are required to take OADM 111, SuperWrite 1, to learn notetaking skills. A business elective may be taken in place of OADM 112.

The Office Administration program includes the opportunity for training in the preparation of medical and legal documents, equipping students for all positions in these specialized fields.

Word processing specialists are qualified to keyboard, revise, and store documents for immediate or future use. Graduates are trained in the various functions of the WordPerfect 5.1 word processing system.

Graduates have the opportunity for training in Lotus 1-2-3, dBase, Microsoft Word For Windows, Graph-In-A-Box, and PageMaker 4.0 software.

Previous Typing Training

Students who have had prior instruction, and received full credit, in typing may receive "K" credit for our Keyboarding 1 and 2.

Special Note: Certain office administration courses are normally offered **only** in the day sections. See your advisor.

Office Administration Technology Curriculum (Sample Schedule)

Course No.	Course	Class Hours	Lab Hours	Credit Hours
FIRST QUARTER				
BMNT 101	Introduction to Business	4	0	4
ENGL 111S	Discourse and Composition	4	0	4
FINA 240 or MATH 125	Personal Finance Business Mathematics	4	0	4
OADM 101	Keyboarding 1	3	1	3
OADM 130	Records Management	3	1	3
	Totals	18	2	18
SECOND QUARTER				
ECON 101	Principles of Economics 1	4	0	4
ENGL 112S	Composition and Research	4	0	4
OADM 102	Keyboarding 2	3	1	3
OADM 111	SuperWrite 1	3	1	3
OADM 221	Word Processing 1	3	1	3
	Totals	17	3	17
THIRD QUARTER				
ENGL 115S	Composition and Literature	4	0	4
OADM 103	Keyboarding 3	3	1	3
OADM 112 ¹	SuperWrite 2	3	1	3
OADM 140	Machine Transcription	3	1	3
OADM 222	Word Processing 2	3	1	3
	Totals	16	4	16
FOURTH QUARTER				
BMNT 242	Business Communications	4	0	4
BUSL 250	Business Law 1	4	0	4
OADM 214	Microcomputer Office Practice	3	1	3
OADM 240	Desktop Publishing	3	1	3
OADM 241	Office Administration 1	3	1	3
	Totals	17	3	17

¹ A business elective may be taken instead of SuperWrite 2.

FIFTH QUARTER				
OADM 215	Lotus 1-2-3	3	1	3
OADM 242	Office Administration 2	3	1	3
OADM 244	Medical/Legal Office Administration	3	1	3
PSYC 101	Introduction to Psychology	4	0	4
SPCH 103	Public Speaking and Human Communication	3	0	3
	Totals	16	3	16
SIXTH QUARTER				
AISM 310	Data Base Management	4	0	4
BMNT 202	Personnel Management	4	0	4
OADM 216	MS Word For Windows	3	1	3
OADM 243	Office Administration 3	3	1	3
SOCI 101	Introduction to Sociology	4	0	4
	Totals	18	2	18

Legal Assisting Technology

Legal Assistants/Paralegals serve as assistants to attorneys and perform many tasks under the supervision of attorneys. The legal assistant's responsibilities may include the following:

- legal and factual research
- interviewing clients and witnesses
- reviewing and organizing material for cases
- drafting legal documents and forms
- functioning as a member of a legal team

Jobs for the legal assistant vary in scope and nature from small to large law firms, financial institutions, corporations, law courts, insurance agencies, banks, department stores, credit departments, and health care facilities. It is one of the fastest growing areas of employment in the United States today.

The legal assisting courses are not theory courses, but rather practical "how to" courses taught by attorneys and judges who have specialized in the area in which they teach. Graduates receive an Associate Degree in Legal Assisting.

Special Note: Because most of the legal assisting (LAST) courses are taught by attorneys and judges, these courses are most often offered in the evening sections.

Legal Assisting Technology Curriculum (Sample Schedule)

Course No.	Course	Course Hours	Lab Hours	Credit Hours
FIRST QUARTER				
ACCT 101	Accounting 1	3	2	4
BUSL 250	Business Law 1	4	0	4
ACCT 101	Accounting 1	3	2	4
BUSL 250	Business Law 1	4	0	4
ENGL 111S	Discourse and Composition	4	0	4
LAST 101	Introduction to Legal Assisting	4	0	4
	Totals	15	2	16
SECOND QUARTER				
ACCT 102	Accounting 2	3	2	4
BUSL 260	Business Law 2	4	0	4
ENGL 112S	Composition and Research	4	0	4
LAST 251	Legal Research and Writing 1	4	0	4
	Totals	15	2	16
THIRD QUARTER				
ENGL 121	Technical Writing	3	0	3
LAST 252	Legal Research and Writing 2	4	0	4

		THIRD QUARTER (cont'd.)		
LAST 262	Introduction to Civil Litigation	4	0	4
SOCI 110S	Foundations of Social Science	4	0	4
	Totals	15	0	15
		FOURTH QUARTER		
LAST 261	Tort Law: Personal Injury Litigation	4	0	4
LAST 263	Introduction to Contracts and Restitution	4	0	4
LAST 269	Criminal Law/Criminal Procedure	4	0	4
PYSC 101	Introduction to Psychology	4	0	4
	Totals	16	0	16
		FIFTH QUARTER		
LAST 264	Computer Applications and The Law	2	3	3
LAST 265	Family Law	4	0	4
LAST 266	Wills, Trusts, and Estate Administration	4	0	4
LAST 270	Evidence	4	0	4
	Totals	14	3	15
		SIXTH QUARTER		
GOVT 250	Introduction to Political Science	4	0	4
LAST 212	Real Estate Law for Legal Assistants	4	0	4
LAST 267	Legal Assisting Practicum	2	14	4
MATH	Mathematics Placement ¹	4	0	4
PHIL 320S ² or	Ethics in Public and Private Life	4	0	4
MGNT 331 or	Business Ethics			
LAST 272	Ethics for Legal Assistants			
	Totals	18	14	20

Note: Minimum total hours required for associate degree in legal assisting is 98.

Associate of Individualized Studies Degree

The associate of individualized studies degree (AIS) at Shawnee State University is designed to allow students the option of formulating their own individualized program of study. The philosophical basis of the degree is predicated upon the assumption that students may be unable to achieve their personal educational goals through one of the more formalized two-year degree structures offered at Shawnee State. This is especially true for students interested in concentrating or combining a selected mixture of courses encompassing both academic as well as technical offerings in a manner which may not meet the degree requirements of Shawnee State's associate of arts, associate of applied science, or associate of applied business degrees. Students desiring more information concerning this degree should contact the registrar.

¹ This course must be MATH 101 or above in addition to any developmental courses determined by the assessment tests.
² Students pursuing the 2+2 social sciences degree should elect to take PHIL 320S.



College of
Engineering
Technologies



1993-1995
Shawnee State University

97

Mission of the College of Engineering Technologies

The principal role of the College of Engineering Technologies is to provide students with the opportunity to develop technical expertise, scientific knowledge, job skills, and work ethics that prepare them for entry into the social-industrial environment. Engineering technology programs provide both theory and practical training, being responsive to technological change and the industrial community while simultaneously stimulating analytical thinking and establishing a foundation for further education and learning.

The College of Engineering Technologies strives to meet the following goals:

- To respond to the varied educational needs of students, the community, and the industrial environment.
- To develop curricula that create an understanding of the practical and scientific bases of selected engineering technologies and to modify curricula and teaching methods in response to technological advancement and change.
- To encourage the development of sound work ethics and a spirit of cooperation and excellence.
- To provide cooperative educational services to assist industries in keeping their employees current with changing technology.
- To seek and encourage participation from the business and industrial community in providing a professional forum for curricular evaluation and program review.
- To promote occupational and educational opportunities for all graduates.

The student's professional education is the College's primary mission, and the quality and success of engineering technologies' graduates provide the ultimate evaluation of the College's mission.

Degrees Offered by the College of Engineering Technologies

Bachelor of Science

Electrical and Computer Engineering Technology
Plastics Engineering Technology

Associate of Applied Science

Computer Aided Drafting and Design
Electromechanical Engineering Technology (Optional Major in Robotics)
Instrumentation and Control Engineering Technology (Optional Major in Robotics)
Plastics Engineering Technology

Certificate

Computer Aided Drafting and Design (CADD)
Computer Technology¹
Plastics Engineering Technology¹

Concentration

Biomedical Engineering Technology¹

Minor

Computer Technology¹
Plastics Engineering Technology¹

Pre-Engineering Curriculum¹

Engineering Technology Programs at Shawnee State

The term "engineering technology" is described by the Accreditation Board for Engineering and Technology as follows:

"Engineering technology is that part of the technological field which requires the application of scientific and engineering knowledge and methods combined with technical skills in support of engineering activities: it lies in the occupational spectrum between the craftsman and the engineer at the end of the spectrum closest to the engineer."

This description reflects the common understanding among people in engineering and related professions that the engineering technologist is a distinct type of professional whose main concern and interest is with existing operation, maintenance, and management of products and processes. Technologists are finding increasing acceptance in positions formerly filled by engineers in such fields as sales, manufacturing, field service, and process engineering.

The programs offered by the College of Engineering Technologies provide the opportunity for graduates to enter careers in the most modern, high-demand segments of industry. All of the programs offer career-oriented, technical instruction grounded in a strong base of science and mathematics. Students who are interested in these programs should prepare themselves by taking mathematics and science courses in high school. Students who did not take mathematics and science courses in high school are advised to take developmental courses available at Shawnee State, preferably during the summer before starting the fall quarter. The University administers placement and assessment tests that can identify deficiencies in mathematics or English and place each student in appropriate courses.

Articulation from Shawnee State's associate degree programs or other colleges' associate degree programs in technology into the junior year of our B.S. programs is possible. Interested students should see their faculty advisors for details.

Graduates of associate degree programs can expect to find jobs as technicians or production operators. Graduates with bachelor degrees are prepared for problem-solving jobs in production management, product development departments, or other technical positions.

Students in the B.S. degree programs in engineering technology are required to complete all courses in the University's general education core. In addition, the College of Engineering Technologies requires that all B.S. degree candidates take a core curriculum of courses in mathematics, physics, computer programming, and engineering technology sciences.

Pass/No-Credit Policy

Students in the College of Engineering Technologies are not permitted to take any course in their major course of study on a pass/no-credit basis. This includes any course that is specifically identified by course number and/or course title offered through the College of Engineering Technologies as a requirement for their graduation.

Bachelor of Science in Electrical and Computer Engineering Technology

The Electrical and Computer Engineering Technology program is designed for the student who wishes to pursue a career as a computing professional and who desires a challenging curriculum which offers a whole approach to computing. Individuals who possess a good understanding of both computer hardware and software are rare, and thus, are in demand. Shawnee State's Electrical and Computer



Engineering Technology program maintains an even balance between computer software and hardware by blending the most critical courses from computer science with those from electrical engineering technology. This provides the student with a solid computing foundation which achieves good overall depth in both hardware and software without sacrificing the important aspects of either.

The electrical and computer program also balances computing theory with application by offering rigorous, high quality courses, which are based on the most recent ACM/IEEE computing curricula guidelines, and adding to each of these courses an applied lab component. These labs are designed to encourage the application of theoretical knowledge of the computing discipline to real-world projects which the student actually builds (software applications, microprocessor-based systems, computer networks).

The Electrical and Computer Engineering Technology program is designed to produce graduates who are suited to any area in which computing-based solutions are needed to solve real-world problems. The overall breadth and depth of their computing and electrical background place graduates of the program in demand for applying computing-based solutions to problems in industry, business, and medicine. In addition, their skills help them to expand the frontiers of society by assisting and enabling those in the arts and sciences to attain greater levels of achievement and understanding in science, literature, art, music, and philosophy through appropriately applied computing technologies.

Careers in computing available to graduates of the Electrical and Computer Engineering Technology program include:

- Software Application Developer
- Hardware Engineer
- Software Engineer
- Local Area Network Specialist
- Data Communications Specialist
- Digital System Designer
- Applied Research and Development Engineer

Due to the demand for individuals with a solid overall computing background, entry level salaries and benefits for graduates of the Electrical and Computer Engineering Technology program are excellent.

The following represents a course breakdown, by category, of the Bachelor of Science in Electrical and Computer Engineering Technology program followed by its quarter-by-quarter description.

Degree Requirements

General Education Core	50 Hours
Mathematics/Science Courses	20 Hours
Drafting/CADD Courses	8 Hours
Electrical Courses	25 Hours
Computer Hardware Courses	27 Hours
Computer Software Courses	50 Hours
Technology Management Courses	9 Hours
Synthesis Courses	14 Hours

**Total Hours Required for Bachelor of Science
Degree in Electrical and Computer Engineering
Technology**

203 Hours

General Education Core (50 Hours)

Course No.	Course	Credit Hours
ENGL 111S	Discourse and Composition	4
ENGL 112S	Composition and Research	4
ENGL 115S	Composition and Literature	4

General Education Core (cont'd.)

Course No.	Course	Credit Hours
ENGL/HIST 225S	Civilization and Literature 1	4
ENGL/HIST 226S	Civilization and Literature 2	4
ENGL/HIST 227S	Civilization and Literature 3	4
PSCI 110S	Physical Science Core Course	4
SOCI 110S	Foundations of Social Science	4
BIOL 110S	Life Sciences Core Course	4
MATH 110S	Mathematics Core Course	4
PHIL 320S	Ethics in Public and Private Life	4
ETCO 485S	Community Involvement	2
ETCO 490S	Senior Seminar	4

Mathematics/Science Courses (20 Hours)

MATH	Mathematics Requirement	4
MATH	Mathematics Requirement	4
MATH	Mathematics Requirement	4
PHYS 201	Physics 1 (Mechanics)	4
PHYS 203	Physics 3 (Energy)	4

Drafting/CADD Courses (8 Hours)

ETCA 101	Introduction to CADD	3
ELEG 101	Engineering Drawing 1	3
ELEM 130	Electromechanical Drawing	2

Electrical Courses (25 Hours)

ETEC 361	Advanced Circuit Analysis 1	3
ETEC 362	Advanced Circuit Analysis 2	4
ETEC 460	Digital Control Systems	4
ELEM 111	Electrical Fundamentals 1 (DC)	4
ELEM 112	Electrical Fundamentals 2 (AC)	4
ELEM 121	Electronics 1	3
ELEM 122	Electronics 2	3

Computer Hardware Courses (27 Hours)

ETEC 241	Microprocessor Circuits 1	3
ETEC 242	Microprocessor Circuits 2	3
ETEC 315	Computer Architecture 1	4
ETEC 316	Computer Architecture 2	4
ETEC 350	Computer System Integration	4
ETEC 375	Networking and Communications 1	3
ELEM 211	Electronic Logic Circuits 1	3
ELEM 212	Electronic Logic Circuits 2	3

Computer Software Courses (50 Hours)

ETCO 110	Computer Software and DOS	2
ETCO 115	Computer Programming for Technology	3
ETEC 102	Structured Programming	3
ETEC 103	Data Structures	3
ETEC 211	Assembly Language Programming 1	3
ETEC 212	Assembly Language Programming 2	3
ETEC 275	Systems Programming	3
ETEC 280	Programming Languages	3
ETEC 371	Operating Systems 1	3
ETEC 372	Operating Systems 2	3
ETEC 373	Advanced Operating Systems	3
ETEC 376	Networking and Communications 2	3
ETEC 408	Algorithms and Problem Solving	3
ETEC 430	Database Systems	3
ETEC 477	Concurrency	3
ETEC 483	Software Engineering	3
ETEC 480	Compiler Design and Implementation	3

Technology Management Courses (9 Hours)

Course No.	Course	Credit Hours
ETCO 225	Industrial Management	3
ETEC 355	Management of Technology	3
ETPL 320	Production Cost Analysis	3

Synthesis Courses (14 Hours)

ENGL 121	Technical Writing	3
ETEC 491	Design Laboratory 1	4
ETEC 492	Design Laboratory 2	4
ETEC 495	Topics in Computing	3

Special Note: The electrical and computer engineering technology classes are normally offered in both day and evening sections. However, during periods of low enrollment, they may be combined into a single class.

Electrical and Computer Engineering Technology Curriculum

Course No.	Course	Class Hours	Lab Hours	Credit Hours
FIRST QUARTER				
ENGL 111S	Discourse and Composition	4	0	4
ETCO 110	Computer Software and DOS	2	0	2
ETCO 115	Computer Programming for Technology	2	3	3
ETEG 101	Engineering Drawing 1	2	3	3
ETEM 111	Electrical Fundamentals 1 (DC)	3	3	4
	Totals	13	9	16
SECOND QUARTER				
ENGL 112S	Composition and Research	4	0	4
ETCA 101	Introduction to CADD	2	3	3
ETEC 102	Structured Programming	2	3	3
ETEM 112	Electrical Fundamentals 2 (AC)	3	3	4
MATH 110S	Mathematics Core Course	4	0	4
	Totals	15	9	18
THIRD QUARTER				
ENGL 115S	Composition and Literature	4	0	4
ETEC 103	Data Structures	2	3	3
ETEM 121	Electronics 1	2	4	3
ETEM 130	Electromechanical Drawing	1	3	2
MATH 220	Discrete Mathematics	4	0	4
	Totals	13	10	16
FOURTH QUARTER				
ENGL 121	Technical Writing	3	0	3
ETEC 211	Assembly Language Programming 1	2	3	3
ETEM 122	Electronics 2	2	3	3
MATH	Elective ¹	4	0	4
PHYS 201 or PHYS 211	Physics 1 (Mechanics)	3	3	4
	Calculus-Based Physics 1			
	Totals	14	9	17
FIFTH QUARTER				
ETCO 225	Industrial Management	3	0	3
ETEC 212	Assembly Language Programming 2	2	3	3
ETEC 241	Microprocessor Circuits 1	2	3	3

¹ Mathematics is an important tool used in engineering technology. Therefore, an engineering technology student is required to complete their mathematics background up through two, 4-credit hour courses in calculus. The mathematics department offers a variety of mathematics courses to assist a student in completing this requirement. The student must be in, or have placed above, MATH 130 (College Algebra 1) to start the engineering technology sequence. In addition to this requirement, MATH 110S is required by the general education core.

FIFTH QUARTER (cont'd.)				
ETEC 280	Programming Languages	2	3	3
ETEM 211	Electronic Logic Circuits 1	3	3	4
	Totals	12	12	16
SIXTH QUARTER				
ETEC 242	Microprocessor Circuits 2	2	3	3
ETEC 275	Systems Programming	2	3	3
ETEM 212	Electronic Logic Circuits 2	3	3	4
MATH	Elective ¹	4	0	4
PHYS 203 or PHYS 212	Physics 3 (Energy)	3	3	4
	Calculus-Based Physics 2			
	Totals	14	12	18
SEVENTH QUARTER				
ETEC 350	Computer System Integration	2	6	4
ETEC 361	Advanced Circuit Analysis 1	3	0	3
ETEC 371	Operating Systems 1	2	3	3
ETEC 375	Networking and Communications 1	2	3	3
PSCI 110S	Physical Science Core Course	4	0	4
	Totals	13	12	17
EIGHTH QUARTER				
ETEC 315	Computer Architecture 1	2	6	4
ETEC 355	Management of Technology	3	0	3
ETEC 362	Advanced Circuit Analysis 2	3	3	4
ETEC 372	Operating Systems 2	2	3	3
ETEC 376	Networking and Communications 2	2	3	3
	Totals	12	15	17
NINTH QUARTER				
BIOL 110S	Life Sciences Core Course	4	0	4
ETEC 316	Computer Architecture 2	2	6	4
ETEC 373	Advanced Operating Systems	2	3	3
ETPL 320	Production Cost Analysis	3	0	3
PHIL 320S	Ethics in Public and Private Life	4	0	4
	Totals	15	9	18
TENTH QUARTER				
ENGL 225S	Civilization and Literature 1	4	0	4
ETEC 408	Algorithms and Problem Solving	2	3	3
ETEC 430	Database Systems	2	3	3
ETEC 460	Digital Control Systems 1	2	6	4
ETEC 483	Software Engineering	2	3	3
	Totals	12	15	17
ELEVENTH QUARTER				
ENGL 226S	Civilization and Literature 2	4	0	4
ETEC 480	Compiler Design and Implementation	2	3	3
ETEC 491	Design Laboratory 1	1	9	4
ETEC 495	Topics in Computing	2	3	3
SOCI 110S	Foundations of Social Science	4	0	4
	Totals	13	15	18
TWELFTH QUARTER				
ENGL 227S	Civilization and Literature 3	4	0	4
ETEC 477	Concurrency	2	3	3
ETEC 492	Design Laboratory 2	1	9	4
ETCO 485S	Community Involvement	0	0	2
ETCO 490S	Senior Seminar	0	0	4
	Totals	7	12	17

¹ Mathematics is an important tool used in engineering technology. Therefore, an engineering technology student is required to complete their mathematics background up through two, 4-credit hour courses in calculus. The mathematics department offers a variety of mathematics courses to assist a student in completing this requirement. The student must be in, or have placed above, MATH 130 (College Algebra 1) to start the engineering technology sequence. In addition to this requirement, MATH 110S is required by the general education core.

Bachelor of Science in Plastics Engineering Technology

Plastics engineering technology applies the concept of engineering technology to the specific domain of plastics processing. Products made by the plastics industry range from simple articles like bottles and cups to highly intricate molded parts for the automotive, electronics, and medical products industries. Their production requires knowledgeable technologists who can design a product, select the best plastic for that product, design a mold, and establish the optimum operating conditions for the machines that are used to mold the product. The Plastics Engineering Technology program prepares the student to become a member of the team that accomplishes these objectives.

The program emphasizes plastics processing operations and includes significant components in the areas of materials, mold design, and production methods. Graduates of the program are expected to have attained a level of expertise which will enable them to assume an entry-level management position in a plastics production environment. Typical job titles are process engineer, project engineer, and production manager.

Degree Requirements

General Education Core (As listed on pages 100 and 101.)	50 Hours
Engineering Technology Courses	14 Hours
Mathematics/Science Courses	24 Hours
Support Courses	36 Hours
Plastics Engineering Technology Courses	81 Hours
Total Hours Required for Bachelor of Science in Plastics Engineering Technology	205 Hours

Engineering Technology Courses (14 Hours)

Course No.	Course	Credit Hours
ETCO 110	Computer Software and DOS	2
ETCO 115	Computer Programming for Technology	3
ETCO 210	Occupational Safety and Health Management	3
ETCO 220	Hydraulics and Pneumatics	3
ETCO 225	Industrial Management	3

Mathematics/Science Courses (24 Hours)

CHEM 121	Introduction to General Chemistry 1	4
CHEM 122	Introduction to General Chemistry 2	4
CHEM 200	Introduction to Organic Chemistry 1	4
MATH	Elective	8
MATH 201	Calculus 1	4

Support Courses (36 Hours)

ECON 102	Principles of Economics 2	4
ENGL 121	Technical Writing	3
ETCA 120	Introduction to CADKEY®	3
ETCO 202	Statics and Strengths of Materials	4
ETCO 230	Introduction to Robotics	3
ETEC 210	Electricity/Electronics Principles	3
ETEG 101	Engineering Drawing 1	3
PHYS 203	Physics 3 (Energy)	4
SPCH 103	Public Speaking and Human Communications	3
	Technical Electives	6

Plastics Engineering Technology Courses (81 Hours)

Processing

Course No.	Course	Credit Hours
ETPL 100	Plastics Manufacturing	3
ETPL 200	Injection Molding	4
ETPL 205	Extrusion/Blow Molding	4
ETPL 210	Thermoforming/Finishing	4
ETPL 215	Thermosetting Processes	4
ETPL 450	Advanced Processing 1	4
ETPL 455	Advanced Processing 2	4

Management/Supervision

ETPL 300	Plastics in Society	2
ETPL 310	Plant Layout and Material Handling	3
ETPL 320	Production Cost Analysis	3
ETPL 440	Advanced Manufacturing Techniques	3

Materials

ETPL 230	Properties of Polymeric Materials	4
ETPL 240	Testing of Plastics	3
ETPL 330	Material Science	3
ETPL 460	Composites	3

Statistics

ETPL 400	Statistical Process/Quality Control 1	4
ETPL 405	Statistical Process/Quality Control 2	4
ETPL 410	Applied Statistical Experimentation	4

Design/Fabrication

ETPL 290	Machine Tools	3
ETPL 420	Plastic Part Design	3
ETPL 425	Mold Design and Analysis 1	4
ETPL 430	Mold Design and Analysis 2	4
ETPL 470	Senior Project	4

Special Note: The plastics engineering technology classes are normally offered in both day and evening sections. However, during periods of low enrollment, they may be combined into a single class.

Plastics Engineering Technology Curriculum

Course No.	Course	Class Hours	Lab Hours	Credit Hours
FIRST QUARTER				
CHEM 121	Introduction to General Chemistry 1	3	3	4
ENGL 111S	Discourse and Composition	4	0	4
ETCO 110	Computer Software and DOS	2	0	2
ETCO 115	Computer Programming for Technology	2	3	3
ETPL 100	Plastics Manufacturing	2	3	3
	Totals	13	9	16
SECOND QUARTER				
CHEM 122	Introduction to General Chemistry 2	3	3	4
ENGL 112S	Composition and Research	4	0	4
ETEG 101	Engineering Drawing 1	2	3	3
MATH 110S	Mathematics Core Course	4	0	4
SPCH 103	Public Speaking and Human Communication	3	0	3
	Totals	16	6	18

THIRD QUARTER				
CHEM 200	Introduction to Organic Chemistry	3	3	4
ENGL 115S	Composition and Literature	4	0	4
ETCA 120	Introduction to CADKEY®	2	3	3
ETPL 200	Injection Molding	3	3	4
MATH	Elective ¹	4	0	4
	Totals	16	9	19
FOURTH QUARTER				
ETCO 210	Occupational Safety and Health Management	3	0	3
ETPL 205	Extrusion/Blow Molding	3	3	4
ETPL 230	Properties of Polymeric Materials	3	3	4
ETPL 240	Testing of Plastics	2	3	3
MATH	Elective ¹	4	0	4
	Totals	15	9	18
FIFTH QUARTER				
ENGL 121	Technical Writing	3	0	3
ETCO 225	Industrial Management	3	0	3
ETEC 210	Electricity/Electronics Principles	3	3	4
ETPL 210	Thermoforming/Finishing	3	3	4
PHYS 201	Physics 1 (Mechanics)	3	3	4
	Totals	15	9	18
SIXTH QUARTER				
ETCO 202	Statics and Strength of Materials	3	3	4
ETCO 220	Hydraulics and Pneumatics	2	3	3
ETPL 215	Thermosetting Processes	3	3	4
PHYS 203	Physics 3 (Energy)	3	3	4
SOCI 110S	Foundations of Social Science	4	0	4
	Totals	15	12	19
SEVENTH QUARTER				
ETPL 290	Machine Tools	2	3	3
ETPL 300	Plastics in Society	2	0	2
ETPL 310	Plant Layout and Material Handling	2	3	3
ETPL 330	Material Science	2	3	3
ETPL 420	Plastic Part Design	2	3	3
	Totals	10	12	14
EIGHTH QUARTER				
BIOL 110S	Life Sciences Core Course	4	0	4
ECON 102	Principles of Economics 2	4	0	4
ETPL 425	Mold Design and Analysis 1	3	3	4
	Technical Elective ²	0	0	3
	Totals	11	3	15
NINTH QUARTER				
ETCO 230	Introduction to Robotics	3	2	3
ETPL 320	Production Cost Analysis	3	0	3
ETPL 430	Mold Design and Analysis 2	3	3	4
PSCI 110S	Physical Science Core Course	4	0	4
	Technical Elective ²	0	0	3
	Totals	13	5	17
TENTH QUARTER				
ENGL 225S	Civilization and Literature 1	4	0	4
ETPL 400	Statistical Process/Quality Control 1	3	3	4
ETPL 440	Advanced Manufacturing Techniques	3	0	3
ETPL 460	Composites	2	3	3
ETPL 470	Senior Project	2	6	4
	Totals	14	12	18

¹ Mathematics is an important tool used in engineering technology. Therefore, an engineering technology student is required to complete 12 credit hours in mathematics courses to fulfill graduation requirements. MATH 110S is required by the general education core and can be counted toward this 12 hour requirement. A 4-credit hour calculus course must also be included as part of this 12-hour credit requirement. The mathematics department offers a variety of courses to assist a student in completing this requirement.

² Technical electives are scheduled by each student's faculty advisor.

ELEVENTH QUARTER				
ENGL 226S	Civilization and Literature 2	4	0	4
ETCO 485S	Community Involvement	0	0	2
ETPL 405	Statistical Process/Quality Control 2	3	3	4
ETPL 450	Advanced Processing 1	3	3	4
PHIL 320S	Ethics in Public and Private Life	4	0	4
	Totals	14	6	18
TWELFTH QUARTER				
ENGL 227S	Civilization and Literature 3	4	0	4
ETCO 490S	Senior Seminar	4	0	4
ETPL 410	Applied Statistical Experimentation	3	3	4
ETPL 455	Advanced Processing 2	3	3	4
	Totals	14	6	16

Associate of Applied Science in Computer Aided Design

The advent of computer aided design is one of the most significant developments in the drafting area. Not only has CADD revolutionized the way in which drawings are produced, but when coupled with computer aided machining (CAM), the entire manufacturing process is bound together and integrated.

Shawnee State's CADD department uses industry standard hardware and software in all classes. All classes utilize the latest release of AutoCAD® unless otherwise stated.

The demand for CADD operators is high and is expected to increase rapidly through the 1990s. Positions for CADD operators exist in all of the following areas.

Aerospace	Medical equipment manufacture
Automotive industries	Packaging
Building and construction	Petroleum
Civil engineering	Piping
Defense	Tool design
Electronics	Transportation
Foundry	Utilities
Machining	Welding

Careers can be developed both locally and abroad. Students graduating from the program expect occupations as, for example, CADD operators, draftspersons, engineering designers, detailers, technical illustrators, and many others.

Suggested Technical Electives

Course No.	Course	Class Hours	Lab Hours	Credit Hours
CISB 201	C Language	2	3	3
ETCO 202	Statics and Strength of Materials	3	3	4
ETEM 111	Electrical Fundamentals 1 (DC)	2	3	3
ETIN 120	Processing Instrumentation	3	3	4
ETPL 100	Introduction to Plastics	2	3	3

CADD Electives *May be used as technical electives.*

ETCA 120	Introduction to CADKEY®	2	3	3
ETCA 150	Computer Aided Machining	2	3	3
ETCA 202	Piping Drawings with CADD	2	3	3
ETCA 203	Welded Parts Design with CADD	2	3	3
ETCA 204	Casting and Mold Design with CADD	2	3	3
ETCA 230	Rendering and Animation	2	3	3
ETCA 285	Special Topics in CADD	?	?	?
ETEG 285	Special Topics in Engineering Drawing	?	?	?

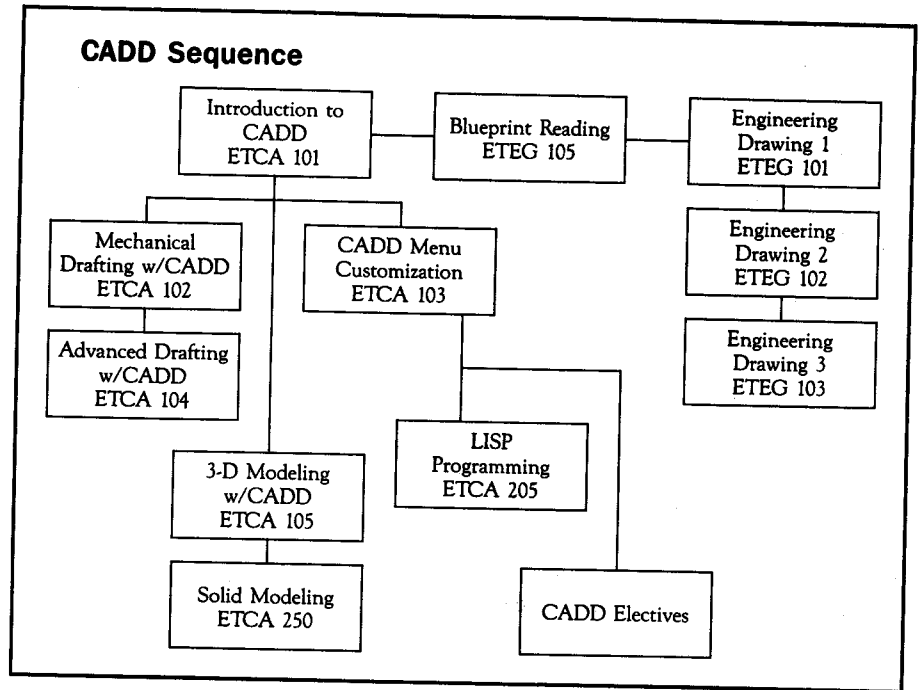

Special Note: The computer aided design classes are normally offered in both day and evening sections. However, during periods of low enrollment, they may be combined into a single class.

Associate of Applied Science in Computer Aided Design Curriculum

Course No.	Course	Class Hours	Lab Hours	Credit Hours
FIRST QUARTER				
ENGL 111S	Discourse and Composition	4	0	4
ETCA 101	Introduction to CADD	2	3	3
ETCO 110	Computer Software and DOS	2	0	2
ETCO 115	Computer Programming for Technology	2	3	3
ETEG 101	Engineering Drawing 1	2	3	3
ETEG 105	Blueprint Reading	2	0	2
	Totals	14	9	17
SECOND QUARTER				
ENGL 112S	Composition and Research	4	0	4
ETCA 102	Mechanical Drafting with CADD	2	3	3
ETCA 103	CADD Menu Customization	2	3	3
ETEG 102	Engineering Drawing 2	2	3	3
MATH	Elective ¹	4	0	4
	Totals	14	9	17
THIRD QUARTER				
ENGL 115S	Composition and Literature	4	0	4
ETCA 104	Advanced Drafting with CADD	2	3	3
ETCA 105	3-D Modeling with CADD	2	3	3

¹ Mathematics is an important tool used in engineering technology. Therefore, an engineering technology student is required to complete 12 credit hours in mathematics courses to fulfill graduation requirements. A 4-credit hour calculus course must be included as part of this 12-credit hour requirement. The mathematics department offers a variety of courses to assist a student in completing this requirement.

THIRD QUARTER (cont'd.)				
ETEG 103	Engineering Drawing 3	2	3	3
MATH	Elective ¹	4	0	4
	Totals	14	9	17
FOURTH QUARTER				
ENGL 121	Technical Writing	3	0	3
ETCA 205	LISP Programming	2	3	3
ETCA	CADD Elective	2	3	3
ETPL 290	Machine Tools	2	3	3
SOCI 110S	Foundations of Social Science	4	0	4
	Totals	13	9	16
FIFTH QUARTER				
ETCA 220	Intergraph Microstation®	2	3	3
ETCO 220	Hydraulics and Pneumatics	2	3	3
MATH	Elective ¹	4	0	4
PHYS 201	Physics 1 (Mechanics)	3	3	4
	Technical Elective	2	3	3
	Totals	13	12	17
SIXTH QUARTER				
ETCA 201	Small Building Design with CADD	2	3	3
ETCA 250	Solid Modeling	2	3	3
ETCA	CADD Elective	2	3	3
ETCO 210	Occupational Safety and Health Management	3	0	3
PHYS 202	Physics 2 (Electricity and Magnetism)	3	3	4
SPCH 103	Public Speaking and Human Communication	3	0	3
	Totals	15	12	19

Associate of Applied Science in Electromechanical Engineering Technology

This degree prepares graduates for many career opportunities in a rapidly-growing segment of the economy. Modern life is very dependent on electromechanical technology. Nearly every aspect of living is dependent on electricity. The Electromechanical Technology program is designed to prepare the individual to become a competent electromechanical technician capable of working and communicating with engineers, scientists, and production personnel.

The job market is almost unlimited for graduates of the Electromechanical Engineering Technology program. Examples of positions in which our graduates are employed include:

- Computer Development Technician
- Computer Service Technician
- Design Technician
- Draftsman
- Electrician
- Electronic Assembler
- Electronic Assembly Foreman
- Instrumentation Technician
- Maintenance Foreman

Entry-level salaries and benefits for graduates of the Electromechanical Engineering Technology program are typically excellent.

¹ Mathematics is an important tool used in engineering technology. Therefore, an engineering technology student is required to complete **12 credit hours** in mathematics courses to fulfill graduation requirements. A 4-credit hour calculus course must be included as part of this 12-credit hour requirement. The mathematics department offers a variety of courses to assist a student in completing this requirement.

Special Note: The electromechanical engineering technology classes are normally offered in both day and evening sections. However, during periods of low enrollment, they may be combined into a single class.

Associate of Applied Science in Electromechanical Engineering Technology Curriculum

Course No.	Course	Class Hours	Lab Hours	Credit Hours
FIRST QUARTER				
ENGL 111S	Discourse and Composition	4	0	4
ETCO 110	Computer Software and DOS	2	0	2
ETCO 115	Computer Programming for Technology	2	3	3
ETEG 101	Engineering Drawing 1	2	3	3
ETEM 111	Electrical Fundamentals 1 (DC)	3	3	4
	Totals	13	9	16
SECOND QUARTER				
ENGL 112S	Composition and Research	4	0	4
ETCA 101	Introduction to CADD	2	3	3
ETEM 112	Electrical Fundamentals 2 (AC)	3	3	4
ETEM 115	Electromechanical Devices	2	3	3
	Totals	11	9	14
THIRD QUARTER				
ENGL 115S	Composition and Literature	4	0	4
ETEM 121	Electronics 1	2	4	3
ETEM 130	Electromechanical Drawing	1	3	2
MATH 110S	Mathematics Core Course	4	0	4
MATH	Elective ¹	4	0	4
	Totals	15	7	17
FOURTH QUARTER				
ENGL 121	Technical Writing	3	0	3
ETCO 210	Occupational Safety and Health Management	3	0	3
ETEM 122	Electronics 2	2	3	3
ETEM 201	Electromechanical Systems	2	3	3
MATH	Elective ¹	4	0	4
PHYS 201	Physics 1 (Mechanics)	3	3	4
	Totals	17	9	20
FIFTH QUARTER				
ETCO 220	Hydraulics and Pneumatics	2	3	3
ETEM 208	Automation Fundamentals	2	3	3
ETEM 209	Robotics	2	3	3
ETEM 211	Electronic Logic Circuits 1	3	3	4
SOCI 110S	Foundations of Social Science	4	0	4
	Totals	13	12	17
SIXTH QUARTER				
ETCO 202	Statics and Strength of Materials	3	3	4
ETEM 212	Electronic Logic Circuits 2	3	3	4
ETEM 215	Electromechanical Design	1	6	3
ETEM 220	Technical Presentations	1	3	2
PHYS 203	Physics 3 (Energy)	3	3	4
	Totals	11	18	17

¹ Mathematics is an important tool used in engineering technology. Therefore, an engineering technology student is required to complete 12 credit hours in mathematics courses to fulfill graduation requirements. MATH 110S is required by the general education core and can be counted toward this 12 hour requirement. A 4-credit hour calculus course must also be included as part of this 12-credit hour requirement. The mathematics department offers a variety of courses to assist a student in completing this requirement.

Robotics Major Option

Students enrolled in Electromechanical Engineering Technology may earn a major in robotics. Students must have advisor approval and must complete 15 credit hours of the following courses in numerical sequence. These courses are offered upon sufficient enrollment.

ETCO 230	Introduction to Robotics or ETEM 209 Robotics
ETRO 211	Robotic Interfacing
ETRO 212	Robotic Applications
ETRO 213	Robotic Maintenance/Serviceing

Associate of Applied Science in Instrumentation and Control Engineering Technology

Instrumentation is the field of science dealing with the art of measurement, control, and process manipulation. The instrumentation technician must calibrate equipment within the standards set by the National Institute of Standards and Technology in Washington, D.C. Although much of this work has been done by electricians and other in-house workers, the rise in automation and computer control has created a need for workers who are specially trained in the field.

This degree prepares graduates for many career opportunities in a rapidly-growing segment of the economy. Modern manufacturing is dependent on instrumentation technology. Every aspect of automation and process control is dependent on the instrumentation technician. The Instrumentation and Control Engineering Technology program is designed to prepare the individual to become a competent instrumentation technician capable of working and communicating with engineers, scientists, and production personnel.

With experience, the job market is almost unlimited for graduates of the Instrumentation and Control Engineering Technology program. Examples of positions in which our graduates are employed include:

- Electrician
- Maintenance Foreman
- Process Operator
- Instrument Technician
- Supervisor of Bio-Med Technicians
- Plant Engineer
- Maintenance Supervisor
- Supervisory Engineer
- Supervisor of Instrumentation and Electrical Technicians

The salaries for graduates of the Instrumentation and Control Engineering Technology program are typically excellent.

Special Note: The instrumentation and control engineering technology classes are normally offered in both day and evening sections. However, during periods of low enrollment, they may be combined into a single class.

Associate of Applied Science in Instrumentation and Control Engineering Technology Curriculum

Course No.	Course	Class Hours	Lab Hours	Credit Hours
FIRST QUARTER				
ENGL 111S	Discourse and Composition	4	0	4
ETCO 110	Computer Software and DOS	2	0	2
ETCO 115	Computer Programming for Technology	2	3	3

1993-1995
Shawnee State University

111

FIRST QUARTER (cont'd.)				
ETEG 101	Engineering Drawing 1	2	3	3
ETEM 111	Electrical Fundamentals 1 (DC)	3	3	4
	Totals	13	9	16
SECOND QUARTER				
CHEM 121	Introduction to General Chemistry 1	3	3	4
ENGL 112S	Composition and Research	4	0	4
ETEG 105	Blueprint Reading	2	0	2
ETEM 112	Electrical Fundamentals 2 (AC)	3	3	4
MATH	Elective ¹	4	0	4
	Totals	16	6	18
THIRD QUARTER				
ENGL 115S	Composition and Literature	4	0	4
ETIN 103	Industrial Electricity	2	3	3
ETIN 111	Industrial Electronics	2	3	3
ETIN 120	Processing Instrumentation	3	3	4
MATH	Elective ¹	4	0	4
	Totals	15	9	18
FOURTH QUARTER				
ENGL 121	Technical Writing	3	0	3
ETIN 201	Instrumentation Electronics	3	3	4
ETIN 202	Programmable Controllers 1	2	5	4
ETIN 221	Instrument Fundamentals	3	3	4
MATH	Elective ¹	4	0	4
	Totals	15	11	19
FIFTH QUARTER				
ETEM 211	Electronic Logic Circuits 1	3	3	4
ETIN 203	Programmable Controllers 2	2	5	4
ETIN 224	Industrial Control 1	3	3	4
PHYS 201	Physics 1 (Mechanics)	3	3	4
SOCI 110S	Foundations of Social Science	4	0	4
	Totals	15	14	20
SIXTH QUARTER				
ETCO 210	Occupational Safety and Health Management	3	0	3
ETCO 220	Hydraulics and Pneumatics	2	3	3
ETIN 223	Measurement Principles	3	3	4
ETIN 225	Distributive Control	3	3	4
PHYS 203	Physics 3 (Energy)	3	3	4
SPCH 103	Public Speaking and Human Communication	3	0	3
	Totals	17	12	21

Concentration in Biomedical Instrumentation²

Students enrolled in Instrumentation and Control Engineering Technology may choose a concentration in biomedical instrumentation, which prepares them for a career in the health care industry.

Course No.	Course	Class Hours	Lab Hours	Credit Hours
FIRST QUARTER				
ENGL 111S	Discourse and Composition	4	0	4
ETCO 110	Computer Software and DOS	2	0	2
ETCO 115	Computer Programming for Technology	2	3	3
ETEG 101	Engineering Drawing 1	2	3	3
ETEM 111	Electrical Fundamentals 1 (DC)	3	3	4
	Totals	13	9	16

1993-1995

Shawnee State University

112

¹ Mathematics is an important tool used in engineering technology. Therefore, an engineering technology student is required to complete 12 credit hours in mathematics courses to fulfill graduation requirements. A 4-credit hour calculus course must be included as part of this 12-credit hour requirement. The mathematics department offers a variety of courses to assist a student in completing this requirement.

² Pending approval

SECOND QUARTER				
CHEM 121	Introduction to General Chemistry 1	3	3	4
ENGL 112S	Composition and Research	4	0	4
ELEG 105	Blueprint Reading	2	0	2
ELEM 112	Electrical Fundamentals 2 (AC)	3	3	4
MATH	Elective ¹	4	0	4
	Totals	16	6	18
THIRD QUARTER				
BIOL 101	Introduction to Biology	3	0	3
ENGL 115S	Composition and Literature	4	0	4
ETIN 111	Industrial Electronics	2	3	3
ETIN 120	Processing Instrumentation	3	3	4
MATH	Elective ¹	4	0	4
	Totals	16	6	18
FOURTH QUARTER				
BIOL 162	Human Anatomy and Physiology	4	3	5
ENGL 121	Technical Writing	3	0	3
ETIN 201	Instrumentation Electronics	3	3	4
ETIN 252	Techniques & Devices for Elect. Troubleshooting	3	3	4
MATH	Elective ¹	4	0	4
	Totals	17	9	20
FIFTH QUARTER				
AHNR 102	Medical Terminology	2	0	2
AHNR 103	Principles of Medical Science	3	0	3
ETIN 251	Biomedical Instrumentation	3	3	4
ETIN 253	Internship 1 Work in Hospital	1	6	3
PHYS 201	Physics 1 (Mechanics)	3	3	4
	Totals	12	12	16
SIXTH QUARTER				
ETIN 261	Instrumentation for Circulatory Systems	2	3	3
ETIN 262	Bio Voltages	2	3	3
ETIN 263	Internship 2 Work in Hospital	1	6	3
PHYS 203	Physics 3 (Energy)	3	3	4
SPCH 103	Public Speaking and Human Communication	3	0	3
	Totals	11	15	16

Robotics Major Option

Students enrolled in Instrumentation and Control Engineering Technology may earn a major in robotics. Students must have advisor approval and must complete 15 credit hours of the following courses in numerical sequence. These courses are offered upon sufficient enrollment.

ETCO 230	Introduction to Robotics or ETEM 209 Robotics
ETRO 211	Robotic Interfacing
ETRO 212	Robotic Applications
ETRO 213	Robotic Maintenance/Serviceing

Associate of Applied Science in Plastics Engineering Technology

Graduates from this associate degree program have the option of applying their two years directly into the bachelor's program in a 2+2 fashion. This gives the student the flexibility to leave at the end of two years or finish the bachelor's degree in four years.

¹ Mathematics is an important tool used in engineering technology. Therefore, an engineering technology student is required to complete 12 credit hours in mathematics courses to fulfill graduation requirements. A 4-credit hour calculus course must be included as part of this 12-credit hour requirement. The mathematics department offers a variety of courses to assist a student in completing this requirement.

Today, plastics is one of the fastest growing industries in the United States. The economic impact of the plastic industry exceeds \$100 billion annually and provides approximately 1.5 million jobs. As plastics continues its rapid growth in both sales and consumption, the industry will continue to lead others in both expansion and stability. Growth of 8% to 16% is projected yearly, creating employment opportunities for the qualified technician.

The Plastics Engineering Technology associate degree program prepares the student to become a valuable and integral part of the multifaceted plastics field.

Graduates of this program are prepared to enter positions dealing with injection molding, extrusion, blow molding, thermoforming, RIM, structural and non-structural foams, rotomolding, supervision, industrial statistics, mold preparation, setup, quality control, production control, fabrication, and semi-professional research and development positions.

Numerous types of supervisory level positions are open to the experienced technician with solid technical training, as well as the ability and desire to assume responsibility.

Positions available to the plastics technology graduate include:

The Process Engineer. Assists company engineers in the development of prototype molds and the troubleshooting of current production molds.

The Production Technician. Operates and supervises the operation of commercial equipment used in the production of plastic items such as an extruder, injection molding machine, and thermoformer.

The Senior Technician. Supervises other technicians in various types of operations and takes part in project or process evaluations.

The Application Research Technician. Blends and compounds plastics with additives, fillers, colors, etc. Assists in selecting proper plastics for specific products and applications.

The Technician Service Representative. Aids customers in the proper selection and use of plastics resin products and in solving customer problems.

Quality Control Technician. Samples raw materials and finished products and performs numerous tests to assure compliance with quality specifications.

The Chemical Sales or Technical Service Representative. Aids customers in the choice of the correct product to purchase and assists in solving customer materials problems.

Special Note: The plastics engineering technology classes are normally offered in both day and evening sections. However, during periods of low enrollment, they may be combined into a single class.

Associate of Applied Science In Plastics Engineering Technology Curriculum

Course No.	Course	Class Hours	Lab Hours	Credit Hours
FIRST QUARTER				
CHEM 121	Introduction to General Chemistry 1	3	3	4
ENGL 111S	Discourse and Composition	4	0	4
ETCO 110	Computer Software and DOS	2	0	2
ETCO 115	Computer Programming for Technology	2	3	3
ETPL 100	Plastics Manufacturing	2	3	3
	Totals	13	9	16
SECOND QUARTER				
CHEM 122	Introduction to General Chemistry 2	3	3	4
ENGL 112S	Composition and Research	4	0	4
ETEG 101	Engineering Drawing 1	2	3	3
MATH 110S	Mathematics Core Course	4	0	4
SPCH 103	Public Speaking and Human Communication	3	0	3
	Totals	16	6	18

THIRD QUARTER				
CHEM 200	Introduction to Organic Chemistry	3	3	4
ENGL 115S	Composition and Literature	4	0	4
ETCA 120	Introduction to 3-D CADD	2	3	3
ETPL 200	Injection Molding	3	3	4
MATH	Elective ¹	4	0	4
	Totals	16	9	19

FOURTH QUARTER				
ETCO 210	Occupational Safety and Health Management	3	0	3
ETPL 205	Extrusion/Blow Molding	3	3	4
ETPL 230	Properties of Polymeric Materials	3	3	4
ETPL 240	Testing of Plastics	2	3	3
MATH	Elective ¹	4	0	4
	Totals	15	9	18

FIFTH QUARTER				
ENGL 121	Technical Writing	3	3	3
ETCO 225	Industrial Management	3	0	3
ETEC 210	Electricity/Electronics Principles	3	3	4
ETPL 210	Thermoforming and Finishing	3	3	4
PHYS 201	Physics 1 (Mechanics)	3	3	4
	Totals	15	12	18

SIXTH QUARTER				
ETCO 202	Statics and Strength of Materials	3	3	4
ETCO 220	Hydraulics and Pneumatics	2	3	3
ETPL 215	Thermosetting Processes	3	3	4
PHYS 203	Physics 3 (Energy)	3	3	4
SOCI 110S	Foundations of Social Science	4	0	4
	Totals	15	12	19

Enrolling students should possess solid mechanical and mathematical skills. Students who successfully complete the two year A.A.S. degree are eligible for entry into the B.S. third and fourth year components.

Computer Aided Drafting and Design Technician Program (One-year Certificate Program)

The CADD certificate prepares graduates for a career in a field that is rapidly replacing the drawing board. Microcomputers have made CADD practical for most companies involved in drafting, design, and engineering. CADD is one of the fastest growing fields today. The demand is expected to increase steadily.

Some unique uses of CADD are in law enforcement, cosmetic dentistry, and cosmetic surgery. CADD operators typically earn higher wages than do conventional drafters.

Special Note: The computer aided drafting and design technology classes are normally offered in both day and evening sections. However, during periods of low enrollment, they may be combined into a single class.

¹ Mathematics is an important tool used in engineering technology. Therefore, an engineering technology student is required to complete 12 credit hours in mathematics courses to fulfill graduation requirements. MATH 110S is required by the general education core and can be counted toward this 12 hour requirement. A 4-credit hour calculus course must also be included as part of this 12-credit hour requirement. The mathematics department offers a variety of courses to assist a student in completing this requirement.

Computer Aided Drafting and Design Technician Program Curriculum

In this four-quarter program, students take eleven drafting courses, three using the conventional drafting board and instruments. The program provides extensive hands-on training in the drafting disciplines.

Course No.	Course	Class Hours	Lab Hours	Credit Hours
FIRST QUARTER				
ETCA 101	Introduction to CADD	2	3	3
ETCO 110	Computer Software and DOS	2	0	2
ETCO 115	Computer Programming for Technology	2	3	3
ETEG 101	Engineering Drawing 1	2	3	3
ETEG 105	Blueprint Reading	2	0	2
MATH 101	Basic Algebra	4	0	4
	Totals	14	9	17
SECOND QUARTER				
ETCA 102	Mechanical Drafting with CADD	2	3	3
ETCA 103	CADD Menu Customization	2	3	3
ETEG 102	Engineering Drawing 2	2	3	3
MATH 105	Plane Geometry and Algebra	4	0	4
	Elective: Advisor approval	2	3	3
	Totals	12	12	16
THIRD QUARTER				
ETCA 104	Advanced Drafting with CADD	2	3	3
ETCA 105	3-D Modeling with CADD	2	3	3
ETCA	CADD Elective	2	3	3
ETEG 103	Engineering Drawing 3	2	3	3
	Elective: Advisor approval	2	3	3
	Totals	10	15	15
FOURTH QUARTER				
ETCA 205	LISP Programming	2	3	3
ETCA	CADD Elective	2	3	3
ETPL 290	Machine Tools	2	3	3
MATH 130	College Algebra 1	4	0	4
	Elective: Advisor approval	2	3	3
	Totals	12	12	16

Plastics Engineering Technology (One-year Certificate Program)

The plastics engineering technology certificate program combines various coursework in plastic processes, production, processing, and the basic plastic science necessary for a realistic grasp of the industry.

Graduates of the program are prepared for entry into one of the largest production environments in the country. Entry-level positions available to individuals with this certificate include machine operator, material handler, mold set-up assistant, and other basic entry-level plastics positions.

With additional production work experiences, graduates may expect to assume higher level entry positions.

Course No.	Course	Credit Hours
FALL QUARTER		
ETCO 110	Computer Software and DOS	2
ETCO 115	Computer Programming for Technology	3

FALL QUARTER (cont'd.)		
ETPL 100	Plastics Manufacturing	3
ETPL 205	Extrusion/Blow Molding	4
ETPL 300	Plastics in Society	2
	Total	14
WINTER QUARTER		
ETCO 225	Industrial Management	3
ETCO 220	Hydraulics and Pneumatics	3
ETEC 210	Introduction to Electricity/Electronics	4
ETEG 101	Engineering Drawing 1	3
ETPL 210	Thermoforming/Finishing	4
	Total	17
SPRING QUARTER		
ETCA 120	Introduction to CADKEY®	3
ETCO 210	Occupational Safety and Health Management	3
ETPL 200	Injection Molding	4
ETPL 215	Thermosetting Processes	4
SPCH 103	Public Speaking and Human Communication	3
	Total	17

Minor in Plastics Engineering Technology¹ (for non-plastics engineering technology baccalaureate degrees)

A minor in plastics engineering technology offers students in any of Shawnee State University's baccalaureate programs an opportunity to broaden their major course of study with an auxiliary focus in plastics engineering technology. The minor requires eight classes (24-25 credit hours) from the plastics engineering technology program. The minor in plastics engineering technology is designed for students in degree programs other than plastics engineering technology. Plastics engineering technology students desiring a minor in plastics should consider the plastics one-year certificate.

Required Courses (17 Hours)

ETCA 120	Introduction to CADKEY®
ETPL 100	Plastics Manufacturing
ETPL 240	Testing of Plastics
ETPL 300	Plastics in Society
ETPL 320	Production Cost Analysis
ETPL 330	Material Science

Elective Courses (7-8 Hours)

Two additional courses from the following list, one of which must be 300 or 400 level. ETPL 200 Injection Molding, ETPL 205 Extrusion/Blow Molding, ETPL 210 Thermoforming/Finishing, ETPL 215 Thermosetting Processes, ETPL 290 Machine Tools, ETPL 400 Statistical Process/Quality Control 1, ETPL 405 Statistical Process/Quality Control 2, ETPL 440 Advanced Manufacturing Techniques, ETPL 450 Advanced Processing 1, ETPL 230 Properties of Polymeric Materials, ETPL 460 Composites

Minor in Computer Technology for Baccalaureate Degree Students and a Certificate in Computer Technology for Non-degree Students¹

Computer technology has had a profound impact on our lives, most obviously through the evolution of the personal computer (PC). In the past decade, the increased power and connectivity of PCs have increased their utility to the point where

¹ Pending approval

they are commonplace throughout business, industry, government, health care, and education. Today's competitive industries and institutions realize the computer age is not coming, but is here now.

This area of study, which leads to a minor for degree students or a certificate for non-degree students, is in keeping with Shawnee State's mission of preparing students for the changing needs of business, industry, education, and society and also the general education core which recognizes that keyboarding skills and the use of programming and applications software are considered essential communication skills.

Graduates and non-degree students who wish to compete in the Third Wave enterprises of the 21st century must

- be technologically literate.
- use appropriate computer terminology when communicating with others.
- understand specific application software: for instance: word processing, spreadsheet, data base management, drafting software (CADD), and desk top publishing.
- accurately use the computer keyboard to input information.
- configure the PC for effective and efficient operation to manage files and data.
- know how to utilize the computer operating system to save information to a disk.
- know how to utilize the computer operating system to retrieve previously saved information from a disk.
- be familiar with, and able to use, programming languages.

Any student enrolled at Shawnee State University may pursue this minor or certificate, except those enrolled in associate or baccalaureate degrees which require eight or more hours of automated information systems management (AISM), computer information systems in business (CISB), electrical/computer engineering technology (ETEC), computer aided drafting design (ETCA), engineering technology core (ETCO), or office administration (OADM) computer courses.

The minor and/or certificate is divided into four components: keyboarding, hardware and operating systems, programming languages, and applications software.

Required Courses (21 Hours)

Keyboarding

Course No.	Course	Credit Hours
OADM 101	Keyboarding 1	3

Computer Hardware, Algorithms, and Operating Systems

CISB 205	Business Data Systems and Communications	3
ETCA 101	Introduction to CADD	3
ETCO 110	Computer Software and DOS ¹	2
ETCO 115	Programming for Technology	3
ETEC 102	Structured Programming	3
ETEC 350	Computer Systems Integration	4

Elective Courses (select three)

Programming Functions

CISB 201	C Language	4
CISB 206	Fortran 77	4
CISB 207	PASCAL Language	4
CISB 208	RPG II Language	4
ETEC 103	Data Structures ²	3

¹ CISB 101 and AISM 101 may be substituted with the approval of the faculty advisor for this minor and certificate program.

² Prerequisites are ETEC 102 and MATH 220. Recommended for mathematics and science majors.

Programming Functions (cont'd.)

Course No.	Course	Credit Hours
ETEC 211	Assembly Language Programming ¹	3
ETEC 212	Assembly Language Programming ²	3
ETEC 280	Programming Languages ²	3

Applications Software

AISM 103	Computer Applications	4
AISM 310	Data Base Management	4
ETCA 105	3-D Modeling with CADD	3
ETCA 120	Introduction to CADKEY®	3
ETCA 230	Rendering and Animation	3
OADM 215	Lotus 1-2-3	4
OADM 216	MS Word for Windows	4
OADM 221	Word Processing 1	3
OADM 222	Word Processing 2	3
OADM 240	Desktop Publishing	3

Credit hours required for completion: 30 to 33

Students in this program will be assigned an advisor in the Electrical/Computer Department of the College of Engineering Technologies.

Associate of Individualized Studies Degree

The associate of individualized studies degree (AIS) at Shawnee State University is designed to allow students the option of formulating their own individualized program of study. The philosophical basis of the degree is predicated upon the assumption that students may be unable to achieve their personal educational goals through one of the more formalized two-year degree structures offered at Shawnee State. This is especially true for students interested in concentrating or combining a selected mixture of courses encompassing both academic as well as technical offerings in a manner which may not meet the degree requirements of Shawnee State's associate of arts, associate of applied science, or associate of applied business degrees. Students desiring more information concerning this degree should contact the registrar.

College of Engineering Technologies Pre-Engineering Curriculum

The College of Engineering Technologies and the College of Arts and Sciences offer a two-year pre-engineering program to students who intend to pursue a career in engineering. Designed for the student who wishes to transfer to a traditional engineering school, this two-year curriculum includes technical, humanities, and liberal arts courses. Pre-engineering students are enrolled in the College of Engineering Technologies or College of Arts and Sciences and are advised by the faculty. These faculty are available to aid students in their decision as to the particular branch of engineering they wish to pursue.

While this curriculum is designed to meet the general needs of many traditional engineering institutions, the student should verify any specific needs of the school and discipline of their choice. In addition, most of this coursework will satisfy scholastic requirements if the student wishes to pursue a degree in engineering

¹ Prerequisite ETEC 103 or advisor approval.

² Prerequisite is ETEC 211.

technology or natural sciences, concentrating in physics, through Shawnee State University. Another option is an associate of science degree in individualized studies with concentrations in a number of technical disciplines.

Pre-Engineering General Course Sequence

Course No.	Course	Credit Hours
FIRST YEAR		
FALL QUARTER		
CHEM 141	General Chemistry 1	4
ENGL 111S	Discourse and Composition	4
ETCO 110	Computer Software and DOS	2
ETCO 115	Computer Programming for Technology	3
MATH 201	Calculus 1	4
	Total	17
WINTER QUARTER		
CHEM 142	General Chemistry 2	4
ENGL 112S	Composition and Research	4
ETEC 102	Structured Programming	3
MATH 202	Calculus 2	4
PSYC 101	Introduction to Psychology	4
	Total	19
SPRING QUARTER		
CHEM 143	General Chemistry 3	4
ECON 101	Principles of Economics	3
ENGL 115S	Composition and Literature	4
ETEC 103	Data Structures	3
MATH 203	Calculus 3	4
	Total	18
SECOND YEAR		
FALL QUARTER		
ENGL 121	Technical Writing	3
ETCA 101	Introduction to CADD	3
ETEG 101	Engineering Drawing	3
MATH 204	Calculus 4	4
PHYS 211	Calculus-Based Physics 1	4
	Total	17
WINTER QUARTER		
ENGL 226S	Civilization and Literature	4
MATH 301	Ordinary Differential Equations	4
PHIL 320S	Ethics in Public and Private Life	4
PHYS 212	Calculus-Based Physics 2	4
	Total	16
SPRING QUARTER		
ENGL 226S	Composition and Literature	4
PHYS 213	Calculus-Based Physics 3	4
SOCI 110S	Foundations of Social Science	3
SOCI 150	Principles of Statistics	4
SPCH 103	Public Speaking and Human Communication	3
	Total	18

Special Notes

- Students starting in an even numbered year should schedule physics in the first year and chemistry in the second. Students starting in an odd numbered year, should follow the schedule shown above.
- Some prerequisites are presumed, and remediation will be required if not met:
 - CHEM 141 requires high school chemistry or CHEM 121 and corequisite of MATH 130.
 - MATH 201 requires placement or the following sequence: MATH 099, 101, 105, 130, 131, 132. (This sequence may be entered at any point.)



College of
Health
Sciences

1993-1995
Shawnee State University

121

Mission of the College of Health Sciences

The College of Health Sciences serves the tri-state area by educating and preparing competent and responsible health-care professionals so that they can deliver the best quality health care possible. The College of Health Sciences also fosters professionalism, personal growth and development, and self-actualization and is committed to continuing professional development for the health-care practitioners in the tri-state area.

Degrees Offered by the College of Health Sciences

- Bachelor of Applied Science¹
 - Concentration in Health Management
- Bachelor of Science in Occupational Therapy¹
- Associate of Applied Science
 - Associate Degree Nursing
 - Dental Hygiene
 - Emergency Medical Technology¹
 - Medical Laboratory Technology
 - Occupational Therapy Assistant
 - Physical Therapist Assistant
 - Radiologic (X-ray) Technology
 - Respiratory Therapy

Bachelor of Applied Science with a Concentration in Health Management¹

This baccalaureate degree program is designed to offer students an opportunity to expand and develop beyond the basic technical knowledge required for entrance into their chosen health care or physical education occupations.

Students may elect to pursue this bachelor's degree in combination with an associate of applied science degree in one of the health science programs. The program is designed to accept the technical courses from the health sciences or HPER (health, physical education, and recreation) programs as "elective requirements" toward this baccalaureate degree. It is also possible for a student to complete this baccalaureate degree without obtaining a licensure in one of the health sciences or physical education programs.

The bachelor of applied science degree in health management will prepare individuals for responsible management positions in a wide variety of medical, health care, and recreational agencies or institutions. Those individuals also earning licensure in one of the health science fields will be better prepared for management/supervisory positions in their health care specialties.

Requirements for Acceptance into the Bachelor of Applied Science Program

Any student accepted for enrollment at Shawnee State University may choose this bachelor of applied science degree program. Admission to this program is **not** selective as is true for the associate degree health science programs. However, students wishing to pursue this degree program **without** being accepted into one of the health science programs must fulfill the "elective" requirements with courses from the natural sciences or the health/physical education sciences.

¹ Pending approval by the Ohio Board of Regents

Graduation Requirements

As displayed by the following chart and detailed by the following lists of courses, a student must successfully complete four curricular areas of study: the university core, the applied science core, electives, and the concentration courses.

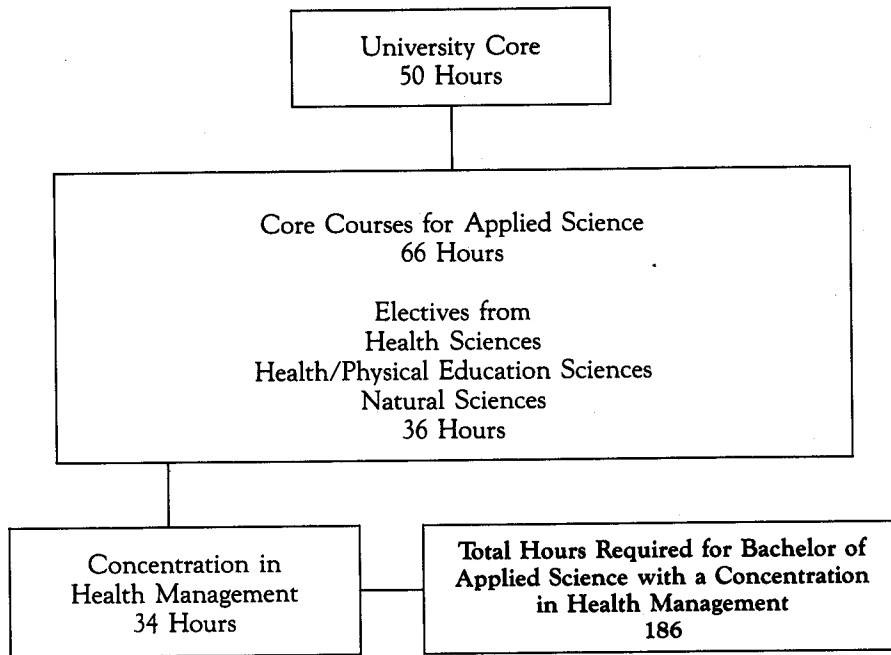

General Education Core (50 Hours)

Course No.	Course	Credit Hours
ENGL 111S	Discourse and Composition	4
ENGL 112S	Composition and Research	4
ENGL 115S	Composition and Literature	4
ENGL/HIST 225S	Civilization and Literature 1	4
ENGL/HIST 226S	Civilization and Literature 2	4
ENGL/HIST 227S	Civilization and Literature 3	4
PSCI 110S	Physical Science Core Course	4
SOCI 110S	Foundations of Social Science	4
BIOL 110S	Life Sciences Core Course	4
MATH 110S	Mathematics Core Course	4
PHIL 320S	Ethics in Public and Private Life	4
ENGL 485S	Community Involvement	2
ENGL 490S	Senior Seminar	4

Applied Science in Health — Core Courses (66 Hours)

Course No.	Course	Credit Hours
AHNR/HPER 202	Personal and Community Health	4
AHNR/HPER 203	Human Nutrition	4
AHNR/HPER 227	First Aid	4
AHNR/HPER 360	Drugs and Substance Abuse	4
BIOL 101 or	Introduction to Biology	3
BIOL 151	Principles of Human Biology	5
BIOL 162 ¹	Human Anatomy/Physiology	5

¹ Students must choose at least two of the four BIOL courses.

Applied Science in Health (cont'd.)

BIOL 310 ¹	Principles of Anatomy	5
BIOL 320 ¹	Principles of Physiology	5
BIOL 350 ¹	Microbiology	5
CHEM 121 or PSCI 105	Introduction to General Chemistry Physical Science	4 5
MATH 150	Principles of Statistics	4
PSYC 101	Introduction to Psychology	4
PSYC 151	Human Growth and Development	4
PSYC 400 ²	Abnormal Psychology	4
PSYC 405 ²	Death and Dying	4
PSYC 420 ²	Community Psychology	4
SOCI 101	Introduction to Sociology	4
SOCI 311	Human Sexuality	4
SPCH 103	Public Speaking and Human Communication	3

Electives (36 Hours)

Health Sciences
Health/Physical Education Sciences
Natural Sciences

Concentration in Health Management (34 Hours)

Course No.	Course	Credit Hours
ACCT 101 ³	Accounting 1	4
ACCT 102 ³	Accounting 2	4
ACCT 410 ⁴	Health Care Accounting/Administration	4
AHNR 310 ^{3, 5}	Orientation to Health Care Systems	3
AHNR 311 ^{4, 5}	Health Record Principles	3
AHNR 312 ^{4, 5}	Health Care Personnel Management	3
AHNR 402 ^{4, 5}	Community Health Education	3
AHNR 410 ^{4, 5}	Patient Care in a Long-Term Health Care Facility	3
AHNR 411 ^{4, 5}	Administration in Long-Term Health Care Facilities	3
AHNR 420 ^{4, 5}	Problems in Health Care Management and Policies	4
AHNR 430 ^{4, 5}	Health Care Finance and Reimbursement	3
AHNR 451 ^{4, 5}	Internship in Health Management	1-6
BMNT 101 ³	Introduction to Business	4
BMNT 102 ³	Marketing Concepts	4
BMNT 330 ³	Organizational Communication	4

Bachelor of Science in Occupational Therapy⁶

To become an occupational therapist, a student must complete an educational program in occupational therapy at either the baccalaureate or graduate level. The proposed program at Shawnee State University leads to a bachelor of science degree with a concentration in occupational therapy. Studies include basic academic subjects in sciences and liberal arts as well as occupational therapy theoretical constructs and practices. The occupational therapy program requires six to nine months of full-time (usually 40 hours per week) internships in a variety of health care settings.

The program is divided into two tracks. One track is for the certified occupational therapy assistant to continue their education, and one is a traditional four-year program.

1993-1995

Shawnee State University

124

¹ Students must choose at least two of the four BIOL courses.

² PSYC 101 and 151 are required. Students must then choose at least two of the remaining PSYC courses.

³ Indicates required course.

⁴ Indicates elective course.

⁵ Indicates new course.

⁶ Pending approval by the Ohio Board of Regents.

Accreditation

The occupational therapy bachelor's program is pending approval from the Ohio Board of Regents. The program will apply for accreditation from the Accreditation Committee of the American Occupational Therapy Association and the Committee on Allied Health Education and Accreditation prior to graduation of the first class.

Admission Requirements

Due to limited enrollment for this program, a selective admission process will be followed.

Students with a standing of second quarter freshman or more shall be considered for admission to the occupational therapy bachelor's program. Traditional baccalaureate students will be admitted during winter quarter of the second year. Students who are certified occupational therapy assistants (proof of certification is required) will be admitted during fall quarter of the fourth year.

Candidates will be selected from applicants who have met the following minimum criteria:

- Cumulative GPA of 2.5 or above on a 4.0 scale after at least 33 hours of college credit (with courses at the 100 and above level). Developmental courses do not apply. For students having a previous bachelors or masters degree, only the last 90 quarter hours of coursework will be used in calculating the cumulative GPA.
- Cumulative GPA of 2.5 or above on a 4.0 scale at time of enrollment in the professional program.
- A minimum of 2.0 in all prerequisite courses at time of application.
- Completion of either high school or college chemistry with a grade of "C" or higher.
- Completion of 40 hours verified volunteer experience in an occupational therapy setting
or
Be a certified occupational therapy assistant (proof of certification is required).
- Completion of the following courses at the time of application:
 - AHNR 102
 - ARTS 231
 - BIOL 101, 110S
 - ENGL 111S, 112S
 - MATH 110S
 - PSYC 101
 - SOCI 101
- Completion of the following courses prior to admission to the program¹:
 - CISB 101
 - ENGL 115S
 - HIST 225S
 - MATH 150
 - PHYS 110S
 - PHYS 201
 - PSYC 151
 - SOCI 110S
- Completion of all required forms and requested materials by the application deadline.

¹ Certified occupational therapy assistants may be required to follow the traditional four-year program if they do not have coursework equivalent to OTAT 103, 110, 205, and 206.

Bachelor of Science in Occupational Therapy Curriculum¹ Four-Year Non-Articulating Track

Course No.	Course	Credit Hours
YEAR 1		
FALL QUARTER		
AHNR 102	Medical Terminology	2
BIOL 101	Principles of Biology	3
ENGL 111S	Discourse and Composition	4
MATH 110S	Mathematics Core Course	4
PSYC 101	Introduction to Psychology	4
	Total	4
		17
WINTER QUARTER		
ARTS 231	Ceramics 1	4
BIOL 110S	Life Sciences Core Course	4
ENGL 112S	Composition and Research	4
SOCI 101	Introduction to Sociology	4
	Total	4
		16
SPRING QUARTER		
ENGL 115S	Composition and Literature	4
PSCI 110S	Physical Science Core Course	4
PSYC 151	Human Growth and Development	4
SOCI 110S	Foundations of Social Science	4
	Total	4
		16
YEAR 2		
FALL QUARTER		
CISB 101	Introduction to Computer Information Systems	4
HIST 225S	Civilization and Literature 1	4
MATH 150	Principles of Statistics	4
PHYS 201	Physics 1 (Mechanics)	4
	Total	4
		16
WINTER QUARTER		
BIOL 310	Principles of Anatomy	5
HIST 226S	Civilization and Literature 2	4
OTAT 101	Introduction to Occupational Therapy	4
PSYC 400	Abnormal Psychology	4
	Total	4
		17
SPRING QUARTER		
BIOL 320	Principles of Physiology	4
HIST 227S	Civilization and Literature 3	4
OTAT 103	Disease Pathology 1	4
OTAT 110	Group Dynamics	4
OTST 310 ²	Practicum 1 for OTS	2
	Total	2
		16
YEAR 3		
FALL QUARTER		
BIOL 311	Kinesiology	3
OTAT 205	Therapeutic Media 2	3
OTAT 206	Contemporary Media in OT	3
OTST 305 ²	Disease Pathology 2	2
PHIL 320S	Ethics in Public and Private Life	4
	Total	4
		16
WINTER QUARTER		
BIOL 314 ²	Human Neuroanatomy	5
OTST 330 ²	Orthotics	3

¹ Pending approval by the Ohio Board of Regents.
² Indicates new course.

	WINTER QUARTER (cont'd.)	
OTST 410 ¹	OT in Physical Disabilities 1	4
OTST 412 ¹	OT in Mental Health 1	4
	Total	16
	SPRING QUARTER	
OTST 411 ¹	OT in Physical Disabilities 2	4
OTST 413 ¹	OT in Mental Health 2	4
OTST 416 ¹	OT in Gerontology	4
OTST 420 ¹	Practicum 2 for OTS	2
	Total	14
	SUMMER QUARTER	
ENGL 485S	Community Involvement	2
OTST 421 ¹	Practicum 3 for OTS	2
OTST 430 ¹	OT in Developmental Disabilities 1	5
	Total	9
	YEAR 4	
	FALL QUARTER	
ENGL 490S	Senior Seminar	4
OTST 431 ¹	OT in Developmental Disabilities 2	4
OTST 450 ¹	Research Designs and Methods in OT	4
OTST 451 ¹	OT Management and Program Planning	4
	Total	16
	WINTER QUARTER	
OTST 495 ¹	Clinical Application 1	12
	SPRING QUARTER	
OTST 496 ¹	Clinical Application 2	12
	Total Hours	194
	SUMMER QUARTER	
OTST 497 ¹	Clinical Application 3 (Optional)	4, 8, or 12

Bachelor of Science in Occupational Therapy Curriculum² 2+3 Articulating Track

Course No.	Course	Credit Hours
	YEAR 1	
	FALL QUARTER	
AHNR 102	Survey of Medical Terminology	2
ARTS 231	Ceramics 1	4
BIOL 101	Principles of Biology	3
CISB 101	Introduction to Computer Information Systems	4
PSYC 101	Introduction to Psychology	4
	Total	17
	WINTER QUARTER	
BIOL 162	Human Anatomy and Physiology	5
OTAT 101	Introduction to Occupational Therapy	4
OTAT 102	Therapeutic Media 1	3
OTAT 108	Practicum 1 (FW1)	2
PSYC 151	Human Growth and Development	4
	Total	18

¹ Indicates new course.

² Pending approval by the Ohio Board of Regents.

SPRING QUARTER		
ENGL 111S	Discourse and Composition	4
OTAT 103	Disease Pathology	4
OTAT 109	Applied Anatomy and Kinesiology	2
OTAT 110	Group Dynamics	2
SOCI 101	Introduction to Sociology	4
	Total	16

SUMMER QUARTER		
ENGL 112S	Composition and Research	4
OTAT 204	Practicum 2 (FW1)	3
OTAT 205	Therapeutic Media 2	3
OTAT 210	OTA in Physical Disabilities	5
	Total	15

YEAR 2

FALL QUARTER		
OTAT 203	OTA in Developmental Disabilities	6
OTAT 206	Contemporary Media in OT	2
OTAT 208	Practicum 3 (FW1)	3
	Psychology/Sociology Elective	4
	Total	15

WINTER QUARTER		
EMTP 101	First Aid and CPR	2
OTAT 209	OTA in Geriatric Program Planning	4
OTAT 211	OTA Seminar	2
OTAT 212	OTA in Mental Health	4
SPCH 103	Public Speaking and Human Communication	3
	Total	15

SPRING QUARTER		
OTAT 220	Clinical Application (FW2)	6
OTAT 221	Clinical Application (FW2)	6
	Total	12

YEAR 3

FALL QUARTER		
BIOL 110S	Life Sciences Core Course	4
HIST 225S	Civilization and Literature 1	4
MATH 110S	Mathematics Core Course	4
PSCI 110S	Physical Science Core Course	4
	Total	16

WINTER QUARTER		
BIOL 310	Principles of Anatomy	5
ENGL 115S	Composition and Literature	4
HIST 226S	Civilization and Literature 2	4
MATH 150	Principles of Statistics	4
	Total	17

SPRING QUARTER		
BIOL 320	Principles of Physiology	4
HIST 227S	Civilization and Literature 3	4
PHYS 201	Physics 1 (Mechanics)	4
PSYC 400	Abnormal Psychology	4
	Total	16

YEAR 4

FALL QUARTER		
BIOL 311	Kinesiology	3
OTST 305 ¹	Disease Pathology 2	4

	FALL QUARTER (cont'd.)	
PHIL 320S	Ethics in Public and Private Life	4
SOCI 110S	Foundations of Social Science	4
	Total	15
	WINTER QUARTER	
BIOL 314 ¹	Human Neuroanatomy	5
OTST 330 ¹	Orthotics	3
OTST 410 ¹	OT in Physical Disabilities 1	4
OTST 412 ¹	OT in Mental Health 1	4
	Total	16
	SPRING QUARTER	
OTST 411 ¹	OT in Physical Disabilities 2	4
OTST 413 ¹	OT in Mental Health 2	4
OTST 416 ¹	OT in Gerontology	4
OTST 420 ¹	Practicum 2 for OTS	2
	Total	14
	SUMMER QUARTER	
ENGL 485S	Community Involvement	2
OTST 421 ¹	Practicum 3 for OTS	2
OTST 430 ¹	OT in Developmental Disabilities 1	5
	Total	9
	YEAR 5	
	FALL QUARTER	
ENGL 490S	Senior Seminar	4
OTST 431 ¹	OT in Developmental Disabilities 2	4
OTST 450 ¹	Research Designs and Methods in OT	4
OTST 451 ¹	OT Management and Program Planning	4
	Total	16
	WINTER QUARTER	
OTST 495 ¹	Clinical Application 1	12
	SPRING QUARTER	
OTST 496 ¹	Clinical Application 2	12
	Total Hours	252
	SUMMER QUARTER	
OTST 497 ¹	Clinical Application 3 (Optional)	4, 8, or 12

Minimum Admission Requirements for Associate Degree Programs

The following requirements apply to all associate degree health science programs:

1. New students must submit an application to Shawnee State University, along with the current non-refundable application fee.
2. Current Shawnee State students wishing to apply for admission to a health science associate degree program should complete a "Change of Major" form, indicating the program they are applying for.
3. Official high school transcript, college transcripts, and GED test scores (along with partial high school transcript) must be submitted. **Please note:** Transcripts must be sent directly from the school to Shawnee State to be considered an "official" transcript. Transcripts delivered by the student are not considered official transcripts.

¹ Indicates new course.

	High School or College Algebra, Biology, and Chemistry (C or above)	20 Hours Volunteer or Work Experience with Disabled or Handicapped	ACT Score of 18 in Science Reasoning Section	ACT Score of 18 in ALL areas	¹ Deadline for Receipt of ALL Application Materials
Associate Degree Nursing ²	✓			✓	February 1
Dental Hygiene	✓		✓		April 1
Emergency Medical Technology ³	✓				April 1
Medical Laboratory ⁴	✓		✓		April 1
Occupational Therapy Assistant	✓	✓			April 1
Physical Therapist Assistant	✓	✓			April 1
Radiologic Technology ⁵	✓		✓		April 1
Respiratory Therapy ⁵	✓		✓		April 1

Figure 1 above indicates requirements of individual associate degree health science programs.

4. Students must have a "C" or above in algebra, biology, and chemistry requirements. A "C-" is not accepted. Students with a "C-" average in one of these courses are not considered for admission.
5. If the ACT test was taken **before** October 1989, students must have a score of "16" in the published requirement areas. On tests taken October 1989 or later, students must have a score of "18" in the published requirements.
6. Students are required to complete an "Autobiography Form." This form is provided to students after the application to the University is received.
7. Students must submit two "Letter of Recommendation" forms. These forms are provided to students after the application to the University is received.
8. Applicants to the Physical Therapist Assistant or Occupational Therapy Assistant programs are required to complete a minimum of 20 hours volunteer or work experience in a facility serving the disabled or handicapped. OTA applicants must work under the direct supervision of either a licensed Occupational Therapy Assistant or Occupational Therapist. Appropriate forms are provided to students after the application to the University is received.
9. When **all** minimum admission criteria have been met, files are forwarded to the appropriate department's chairperson. Students **are not** considered for admission to a health science associate degree program until **all** minimum admission requirements are completed.

¹ After application deadline, students who have completed application materials are accepted on space available basis.

² ADN applicants must be eligible for ENGL 111S.

³ Pending approval by the Ohio Board of Regents

⁴ Medical Laboratory students must place in MATH 105 or earn at least a grade of "C" in MATH 101. Also, students must place in ENGL 111S or earn at least a grade of "C" in ENGL 099 or UNIV 101.

⁵ Radiologic Technology and Respiratory Therapy applicants must be eligible to enter MATH 130 and ENGL 111S as the program curriculum describes.

10. Applicants to the Medical Laboratory program have a meeting with the department's chairperson when their file is complete. Applicants to the other programs are contacted if further information is needed.
11. Students should take Shawnee State's mathematics and English placement tests as early as possible.
12. Physical examinations are required for students who have been officially accepted into a health science program. Forms are provided by the department.

Questions regarding admission procedures or application status should be directed to the College of Health Sciences Admission Office at (614) 355-2225.

Please Note:

Fulfilling the criteria for admission into a College of Health Sciences program **does not** automatically guarantee the applicant entrance into the program. Since the number of candidates who meet the minimal criteria for admission generally far exceeds the number of vacancies, each program ranks the candidates using selected criteria **in addition** to the minimal admission requirements. For example, this additional criteria may include, but is not limited to, high school and/or college grade point average; professional references; completion of additional coursework in college level biology, mathematics, and chemistry; work experience; and autobiographies. Applicants may obtain information as to the criteria used for the ranking of applicants by contacting the department's chairperson or the dean's office.

Some programs of the College of Health Sciences utilize hospital clinical sites for the completion of their requirements for graduation. These affiliating hospitals have the right to accept or reject a student, which could result in a student's being delayed in a program or unable to complete the requirements for graduation.

If any applicant to the College of Health Sciences has a conviction record for certain classes of misdemeanors or any felony, he/she may be ineligible for licensure in specific health occupations. Also, the affiliating hospitals have the right to reject students due to a criminal record.

Health Science Class Schedule

The majority of all health science classes are scheduled within the 8:00 a.m. to 5:00 p.m. times. However, students in the health sciences programs should be aware that it may be necessary to schedule their required classes in English, natural sciences, and humanities during the evening hours as the required clinical and laboratory times in the health science courses will involve many hours during the 8:00 to 5:00 day schedules.

Pass/No-Credit Policy

Students in the College of Health Sciences are not permitted to take courses on a pass/no-credit basis. This applies to courses taken in preparation for admission to the health sciences programs as well as courses taken after admission to a program. Classes may be taken for non-credit, but **only** with the prior permission of the health science department's chairperson.

Guidelines for Appealing a Dismissal From a College of Health Sciences Program

Each of the programs within the College of Health Sciences has set minimum academic and clinical performance standards which will permit a student to continue in that program. Failure to meet these minimum performance standards will

result in dismissal from the program. Information concerning these performance standards is available in this catalog, the student handbook for individual programs, or from the office of the department's chairperson.

If a student wishes to appeal his/her dismissal from a health science program, the following sequence of events shall be followed:

1. Within three working days following a student's notification of dismissal from the health science program, the student must request in writing a meeting with the department's chairperson to appeal the dismissal. The student shall be notified of the results of this appeal within two working days following this meeting. Students unsatisfied with the decision may request, within three working days, a second appeal hearing.
2. Upon the student's written request for the next level of appeal, the department's chairperson shall arrange a joint meeting with the student, the department's chairperson (or designee), the dean of the College of Health Sciences (or designee), and the provost (or designee). The student shall be notified of the results of this appeal hearing within two working days following the meeting.

Criteria to be used in ruling on a student's dismissal appeal include the student's past academic achievement, the student's rationale for current grade status, and the prediction of future performance in the program.

Dismissal from a health science program is not the same as dismissal from the University. University dismissal policies are outlined in this catalog under the section titled "Services, Fees, and Facilities."

Associate Degree Nursing

Associate degree nursing students graduating from Shawnee State University are qualified to take the NCLEX-RN examination¹ for registered nurses and after successfully passing this examination are capable of providing nursing care at a beginning level in hospitals, nursing homes, doctors' offices, clinics, and selected public health agencies.

Accreditation

The Associate Degree Nursing program has full approval by the Ohio Board of Nursing.

Please Note:

1. All suggested or equivalent courses listed for the first three quarters must be completed prior to continuing into the second year. Prerequisites for each quarter are identified under course descriptions.
2. For a student to remain in good academic standing in the Associate Degree Nursing program, a grade of "C" (2.0) or better must be achieved in each course included in the curriculum. Failure to do so may result in academic dismissal from the program. Students requesting readmission must do so in writing within one quarter of leaving the program in order to obtain the requirements and forms from the nursing department.
3. Only those students who have been officially accepted into the program or who have received the approval of the department's chairperson may take the courses beginning with the ADNR prefix.
4. Students must have a current CPR certification or enroll in EMTA 102.

¹ Felony conviction requires permission from Ohio Board of Nursing before taking the examination.

Associate Degree Nursing Curriculum

Course No.	Course	Class Hours	Lab Hours	Credit Hours
FIRST QUARTER				
ADNR 101	Nursing 1	5	9	8
AHNR 103 ¹	Principles of Medical Science	3	0	3
BIOL 101 ¹	Introduction to Biology	3	0	3
ENGL 111S	Discourse and Composition	4	0	4
	Totals	15	9	18
SECOND QUARTER				
ADNR 102	Nursing 2	5	9	8
BIOL 310	Principles of Anatomy	4	3	5
PSYC 101	Introduction to Psychology	4	0	4
	Totals	13	12	17
THIRD QUARTER				
ADNR 103	Nursing 3	4	12	8
BIOL 320	Principles of Physiology	5	0	5
PSYC 151	Human Growth and Development	4	0	4
	Totals	13	12	17
SUMMER QUARTER (Optional): The following courses may be taken in the summer or during the second year as designated.				
BIOL 350	Microbiology 1 (or fourth quarter)	4	3	5
ENGL 112S	Composition and Research (or fifth quarter)	4	0	4
SOCI 101	Introduction to Sociology (or fifth quarter)	4	0	4
	Totals	12	3	13
FOURTH/FIFTH QUARTER				
ADNR 201 ²	Nursing 4	6	12	5
ADNR 202 ²	Nursing 5	6	12	5
ADNR 203	Nursing 6	2	0	2
BIOL 350	Microbiology 1 (fourth quarter)	4	3	5
	Totals	12	15	17
FOURTH/FIFTH QUARTER				
ADNR 204	Nursing 7	6	12	10
ENGL 112S	Composition and Research (fifth quarter)	4	0	4
SOCI 101	Introduction to Sociology (fifth quarter)	4	0	4
	Totals	14	12	18
SIXTH QUARTER				
ADNR 205	Nursing 8	4	15	9
ADNR 211	Nursing 9	3	0	3
³	Approved Elective	4	0	4
	Totals	11	15	16



Dental Hygiene

Dental hygiene is a vital health service component of dentistry which emphasizes oral health and the prevention of oral diseases.

Most dental hygienists are employed in private dental offices or clinics and work under the supervision of the dentist. The hygienist's main function is performing oral prophylaxis—scaling and polishing of the patient's teeth to remove soft and

¹ Students who are planning to continue their education toward a baccalaureate degree are encouraged to substitute CHEM 121 for AHNR 103 and BIOL 151 for BIOL 101.

² May be half-quarter course.

³ Elective must be approved by nursing advisor.

hard deposits. They also perform other procedures: dental charting and oral examinations, exposing and processing dental radiographs, fluoride treatments, and preliminary impressions for study models. The hygienist also places great emphasis on dental health education, home care, brushing/flossing, and diet/nutritional counseling.

Accreditation

The Dental Hygiene program is accredited by the American Dental Association.

Job Opportunities

Dental hygienists practice in the following areas:

- a. Dentists in private practice.
- b. School systems—Primarily concerned with the proper care of children's teeth. Inspect students' teeth and report findings to a supervising dentist. May also instruct students in proper care of teeth, give demonstrations on the proper use of a toothbrush, and present talks on nutrition and its effects on dental health.
- c. Hospitals and clinics—Concerned primarily with the special oral health problems of the bedridden and chronically ill.
- d. Teaching and research—Hygienists with advanced degrees may be employed in research or may teach in dental hygiene educational programs that help students to prepare for the profession.

Academic Requirements for Dental Hygiene

In order to remain in good academic standing in the Dental Hygiene program, a student must:

1. Maintain a cumulative GPA of 2.0 in all coursework needed to meet the requirements for an Associate of Applied Science degree in Dental Hygiene. This applies to all required courses taken before as well as after admission into the Dental Hygiene program.
2. Maintain a cumulative GPA of 2.0 in all dental hygiene courses.
3. Not receive a failing grade in any of the required courses for the Dental Hygiene program.

Students who fail to achieve *any one of the three* requirements for good academic standing will be dismissed from the Dental Hygiene program with the option of reapplying for admission the following year. A student may appeal a dismissal from the Dental Hygiene program by following the guidelines for appeal as detailed in this catalog.

Please Note:

1. After the first quarter courses, all subsequent basic and technical courses are closely related and, therefore, must be taken in sequential order.
2. Only those students who have been officially accepted into the program or who have received the approval of the department's chairperson may take the courses beginning with the DTHY prefix.

Dental Hygiene Curriculum

Course No.	Course	Class Hours	Lab Hours	Credit Hours
FIRST QUARTER				
AHNR 103	Principles of Medical Science	3	0	3
BIOL 101	Introduction to Biology	3	0	3

FIRST QUARTER (cont'd.)				
DTHY 111	Oral Anatomy 1	3	0	3
DTHY 121	Clinical Dental Hygiene 1	2	6	4
	Totals	11	6	13
SECOND QUARTER				
BIOL 162	Human Anatomy/Physiology	4	3	5
DTHY 101	Radiology 1	2	0	2
DTHY 102	Oral Histology/Embryo	3	0	3
DTHY 112	Oral Anatomy 2	2	0	2
DTHY 122	Clinical Dental Hygiene 2	2	6	4
	Totals	13	9	16
THIRD QUARTER				
DTHY 113	Radiology 2	1	3	2
DTHY 123	Clinical Dental Hygiene 3	1	8	4
DTHY 202	Periodontics	3	0	3
DTHY 220	Oral Microbiology/Immunology	3	0	3
¹	English/Humanities/Social Sciences	4	0	4
	Totals	12	11	16
FOURTH QUARTER (Summer)				
DTHY 203	Dental Materials	2	3	3
DTHY 205	Dental Health Education	3	0	3
DTHY 224	Clinical Dental Hygiene 4/Office Emergencies	2	9	5
DTHY 290	Seminar in Advanced Periodontics	1-3	0	1-3
	Totals	8-10	12	12-14
FIFTH QUARTER				
DTHY 103	Human Nutrition	3	0	3
DTHY 201	General and Oral Pathology	3	0	3
DTHY 225	Clinical Dental Hygiene 5/Special Needs	2	9	5
¹	English/Humanities/Social Sciences	4	0	4
	Totals	12	9	15
SIXTH QUARTER				
DTHY 204	Pharmacology	3	0	3
DTHY 206	Public Health	3	0	3
DTHY 226	Clinical D.H. 6/Prevent. Dent. & Jurisprud.	1	12	5
¹	English/Humanities/Social Sciences	4	0	4
	Totals	11	12	15
SEVENTH QUARTER				
DTHY 227	Clinical D.H. 7/Career Management	1	9	4
¹	English/Humanities/Social Sciences	7	0	7
²	Elective	3	0	3
	Totals	11	9	14

Emergency Medical Technology³

Emergency Medical Technicians are health care professionals who provide emergency treatment to patients in the prehospital environment. Several levels of training are available for Emergency Medical Technicians. The entry level for the profession is the Emergency Medical Technician-Ambulance (EMT-A). Education for this level of emergency care provider is the 110-hour Emergency Victim Care course (EMTP 110). The Advanced Emergency Medical Technician-Ambulance (AEMT-A) is able to provide emergency care at a high level, utilizing advanced skills in airway and shock management. Educational preparation for the Advanced EMT-A

¹ English/Humanities/Social Science requirements: ENGL 111S, ENGL 112S, PSYC 101, SPCH 103, SOCI 101.

² 3-Credit Hour Elective: Any English, psychology, speech, or sociology course with a catalog number higher than the required courses listed above. Any business management, personnel management, computer course, or HPER 202 - Personal and Community Health.

³ Pending approval by the Ohio Board of Regents.

is included in EMTP 210 through 212. The Emergency Medical Technician-Paramedic (EMTP) is the highest level of certified emergency care provider. The Paramedic receives education in a program of study encompassing seven courses in addition to the EMT-A and Advanced EMT-A courses (EMTP 210 through 241). This education includes classroom and laboratory instruction, as well as hospital and field clinical experiences.

As part of the initial educational experience, or for career advancement, the student may elect to pursue the Associate of Applied Science degree in Emergency Medical Technology. This two-year program is intended to expand the knowledge and experience base of the EMT-Paramedic in both general academics and prehospital emergency medicine.

Accreditation

The EMT-A and Paramedic training programs are accredited by the Ohio Department of Highway Safety, Division of Public Safety Services.

Academic Requirements for Emergency Medical Technology

In order to remain in good academic standing in the Emergency Medical Technology program, a student must:

1. Maintain a grade point average of 2.0 in all coursework needed to meet the requirements for an Associate of Applied Science degree in Emergency Medical Technology. This applies to all required courses taken before as well as after admission in the Emergency Medical program.
2. Maintain a grade point average of 2.0 in all Emergency Medical Technology courses.
3. Not receive a failing grade in any of the required courses for the Emergency Medical Technology program.

Students who fail to achieve *any one of the three* requirements for good academic standing will be dismissed from the Emergency Medical Technology program with the option of reapplying for admission the following year. A student may appeal a dismissal from the Emergency Medical Technology program by following the guidelines for appeal as detailed in this catalog.

Please Note:

1. After the first quarter courses, all subsequent basic and technical courses are closely related and, therefore, must be taken in sequential order.
2. Only those students who have been officially accepted into the program or who have received the approval of the department's chairperson may take the courses beginning with the EMTP prefix, except EMTP 101 and 102.

Entrance Requirements

EMT-A Course (EMTP 110)

1. Minimum of 18 years of age
2. High school diploma or equivalent
3. Current, unconditional drivers license
4. Completed Pre-Entrance Medical Record
5. Completed university application
6. Evidence that the applicant is not currently charged with, incarcerated for, and/or on parole or probation for a felony charge

Advanced EMT-A Course (EMTP 210, EMTP 211, EMTP 212)

Numbers 1-6 above, and:

7. Current Ohio EMT-A certification

8. Evidence of not less than six months' experience providing prehospital care in the prehospital setting
9. Letter of recommendation from a supervisor of the Emergency Medical Service with which the above requirement was met
10. Conference with the chairperson of the department, showing evidence of maturity, good judgement, and good moral character

Paramedic Program (EMTP 210 through 242)

Numbers 1-10 above, and:

11. Successful completion of the National Registry of EMT's basic or intermediate level examination
12. Completion of an examination which addresses aptitude in reading, writing, and mathematics skills. Remedial education in deficient areas may be required.

Emergency Medical Technology Curriculum (Associate Degree)¹

Course No.	Course	Class Hours	Lab Hours	Credit Hours
FIRST QUARTER				
AHNR 102	Medical Terminology	2	0	2
BIOL 101	Introduction to Biology	3	0	3
EMTP 102	Cardiopulmonary Resuscitation	1	0	1
EMTP 110	Emergency Victim Care	9	3	10
	Totals	15	3	16
SECOND QUARTER				
EMTP 120	EMS Systems	3	0	3
ENGL 111S	Discourse and Composition	4	0	4
PSYC 101	Introduction to Psychology	4	0	4
SPCH 103	Public Speaking and Human Communication	3	0	3
	Totals	14	0	14
THIRD QUARTER				
AISM 101	Intro. to Automated Information Systems	4	0	4
EMTP 130	Major Incident Response	2	0	2
ENGL 112S	Composition and Research	4	0	4
SOCI 101	Introduction to Sociology	4	0	4
	Totals	14	0	14
FOURTH QUARTER (optional)				
General Electives				
FIFTH QUARTER				
EMTP 210	Paramedic Skills 1	5	0	5
EMTP 211	Paramedic Skills 1 Lab	0	2	1
EMTP 212	Paramedic Skills 1 Clinical	0	4	1
EMTP 220	Paramedic Skills 2	3	2	3
	General Elective	4-5	0	4-5
	Totals	12-13	8	14-15
SIXTH QUARTER				
EMTP 230	Paramedic Skills 3	8	0	8
EMTP 231	Paramedic Skills 3 Lab	0	3	1
EMTP 232	Paramedic Skills 3 Clinical	0	4	1
	EMS Elective	1-4	0	1-4
	General Elective	4-5	0	4-5
	Totals	13-17	7	15-19

¹ Pending approval by the Ohio Board of Regents.

SEVENTH QUARTER

EMTP 240	Paramedic Skills 4	8	0	8
EMTP 241	Paramedic Skills 4 Lab	0	3	1
EMTP 242	Paramedic Skills 4 Clinical	0	4	1
EMTP 250	Advanced Emergency Procedures	2	2	3
	General Elective	4-5	0	4-5
	Totals	14-15	9	17-18

Approved Electives—to Total 23 to 37 Credits

Course No.	Course	Credit Hours
<i>Choose at least two of the following:</i>		
AHNR 312	Health Care Personnel Mgt.	3
BIOL 110S	Life Sciences Core Course	4
BIOL 162	Human Anatomy and Physiology	5
BIOL 310	Principles of Anatomy	5
BIOL 320	Principles of Physiology	3
BIOL 321	Human Physiology Lab	2
BIOL 350	Microbiology	5
ENGL 115S	Composition and Literature	4
MATH 110S	Mathematics Core Course	4
PSCI 110S	Physical Science Core Course	4
SOCI 110S	Foundations of Social Science	4
<i>Choose at least two of the following:</i>		
BMNT 201	Management Concepts	4
BMNT 202	Personnel Management	4
ECON 101	Principles of Economics	4
PSYC 151	Human Growth and Development	4
PSYC 405	Death and Dying	4
<i>Technical Electives</i>		
EMTP 215	Advanced EMT Defibrillation	4
EMTP 260	EMS Field Studies	3
EMTP 270	EMS Management	3
EMTP 295	Special Topics in EMS	1-4

Medical Laboratory Technology

Medical laboratory technology, a medically oriented discipline, occupies an essential and responsible position in laboratory medicine. Physicians rely on the laboratory staff and the results of their analyses to aid them in determining the presence and extent of disease, as well as implications pertaining to the cause of disease. They also provide data needed to evaluate the effectiveness of treatment and patient management.

The medical laboratory technician works under the supervision of a pathologist or technologist and is qualified to perform a wide variety of analytical tests on patient specimens in the areas of hematology, chemistry, microbiology, immunology, immunohematology, and urinalysis. Individuals must be accurate and conscientious, with manual dexterity and an interest in science, have an inquiring mind, and a recognition of their responsibility for human lives.

The associate degree Medical Laboratory Technology program is designed to provide basic educational background and the clinical environment in which students can acquire knowledge, skills, and competence to properly perform routine and selected specialized analyses in a clinical laboratory.

The curriculum consists of seven academic quarters of general education, basic science, and clinical laboratory sciences, including an 18-week internship in one of the affiliated hospitals.

Certification

Upon successful completion of this program, the student receives the associate of applied science degree and is eligible to take the American Society of Clinical Pathologists' Board of Registry Examination and/or the National Certification Agency for Medical Laboratory Personnel Examination as a certified medical/clinical laboratory technician.

Accreditation

The MLT-AD program is accredited by the Committee on Allied Health Education and Accreditation of the American Medical Association, in collaboration with the National Accrediting Agency for Clinical Laboratory Sciences (NAACLS).

Employment Opportunities

Positions for certified medical laboratory technicians are available in hospital laboratories, commercial laboratories, public health facilities, the armed forces, physicians' offices, clinics, pharmaceutical and industrial firms, research and educational institutions, as well as the biomedical supply and instrument industry (as technical and sales representatives).

Scholarships

A medical laboratory scholarship, covering two-year tuition, is awarded each year to a high school graduate who demonstrates academic excellence and has been accepted into the Medical Laboratory Technology program.

Academic Requirements in the Medical Laboratory Program

1. Eligibility for clinical practicum, as well as continuation in the Medical Laboratory Technology program, requires that students maintain a 2.0 cumulative GPA, a minimum of "C" in the lecture and lab portion of all MLTC courses, and a minimum of "C" in all required courses. Detailed academic requirements are outlined in the MLTC student handbook.
2. Only those students who have been officially accepted into the program or who have received the approval of the department's chairperson may take the courses beginning with the MLTC prefix.

Medical Laboratory Technology Curriculum

Course No.	Course	Class Hours	Lab Hours	Credit Hours
FIRST QUARTER				
BIOL 101 ¹	Introduction to Biology	3	0	3
CHEM 121 ²	Introduction to General Chemistry 1	3	3	4
ENGL 111S	Discourse and Composition	4	0	4
MATH 130	College Algebra 1	4	0	4
MLTC 111	Medical Technology Orientation	2	0	2
	Totals	16	3	17
SECOND QUARTER				
BIOL 162 ¹	Human Anatomy and Physiology	4	2	5
CHEM 122 ²	Introduction to General Chemistry 2	3	3	4

¹ Students who are planning to continue their education toward a baccalaureate degree are encouraged to substitute BIOL 151 for BIOL 101 and BIOL 310 and 320 for BIOL 162.

² Students who are planning to continue their education toward a baccalaureate degree are advised to register for CHEM 141, 142. Eligibility for or completion of MATH 130 is required.

SECOND QUARTER (cont'd.)				
ENGL 112S	Composition and Research	4	0	4
MLTC 112	Basic Laboratory Skills	2	6	4
	Totals	13	11	17
THIRD QUARTER				
CHEM 200	Introduction to Organic Chemistry 1	3	3	4
MLTC 209	Hematology 1	2	6	4
MLTC 210	Hemostasis	2	2	2
MLTC 212	Clinical Chemistry 1	2	6	4
PSYC 101	Introduction to Psychology	4	0	4
	Totals	13	17	18
FOURTH QUARTER				
BIOL 350	Microbiology	4	3	5
MLTC 202	Immunoserology	2	3	3
MLTC 207	Clinical Microbiology	3	6	5
MLTC 211	Hematology 2	2	3	3
	Totals	11	15	16
FIFTH QUARTER				
MLTC 201	Urinalysis	2	3	3
MLTC 203	Blood Banking	2	6	4
MLTC 204	Parasitology	1	2	1
MLTC 213	Clinical Chemistry 2	2	6	4
SPCH 103	Public Speaking and Human Communication	3	0	3
	Totals	10	17	15
SIXTH QUARTER				
MLTC 215	Laboratory Simulation (first five weeks)	0	9	3
MLTC 216	Medical Technology Seminar (first five weeks)	1	0	1
MLTC 217	Case Studies (first five weeks)	1	0	1
MLTC 220	Clinical Practicum (second five weeks)	0	40	4
SOCI 101	Introduction to Sociology	4	0	4
	Totals	6	49	13
SEVENTH QUARTER				
MLTC 221	Clinical Practicum 2	0	40	8
MLTC 225	Special Problems in Medical Laboratory	2	0	2
MLTC 226	Technical Electives ¹	2	0	2
	Totals	4	40	12

Occupational Therapy Assistant (Associate Degree)

Occupational therapy is a vital health care service that uses "occupation," meaning purposeful activity, as the basis for treatment of people with a wide variety of physical, developmental, and emotional disabilities.

Occupational therapists and occupational therapy assistants help disabled people of all ages acquire or regain the skills they need to live independent, productive, and satisfying lives. They work in hospitals, rehabilitation centers, nursing homes, public and private schools, and home health agencies.

¹ MLTC 226 Technical Electives: Special Topics in Laboratory Instrumentation, Special Topics in Laboratory Management, Special Topics in Quality Control and Computer, Special Topics in Hematology, Special Topics in Clinical Chemistry, Special Topics in Immunology, Special Topics in Immunohematology, Special Topics in Microbiology, Special Topics in Urinalysis, Special Topics in Histology

Recommended electives for students who want to take additional hours: CISB 101 Introduction to Computer Information Systems in Business, CISB 103 BASIC Language 1, BIOL 450 Immunology, CHEM 223 Quantitative Analysis, ENGL 115S Composition and Literature, ENGL 121 Technical Writing, MATH 131 College Algebra 2, MATH 150 Principles of Statistics

Occupational therapy assistants work under the guidance of occupational therapists. They may choose or construct equipment that helps people to function more independently; they may carry out treatment activities for individuals or groups of patients; and they work closely with families of patients who are preparing to return home.

To become an occupational therapy assistant, a student must complete an educational program. The majority of these are two-year associate degree programs like the one at Shawnee State University. Studies include basic academic subjects, human growth and development, the functioning of the human body, and occupational therapy principles and techniques. The OTA program requires at least two, six-week rotations of supervised practical experience in a variety of health care settings.

After successfully completing the educational program, the graduate is eligible to take the national certification examination for the occupational therapy assistant. Many states, including Ohio, Kentucky, and West Virginia, also require licensing by their respective states to practice occupational therapy.

Accreditation

The Occupational Therapy Assistant program at Shawnee State is approved by the Accreditation Committee of the American Occupational Therapy Association and is accredited by the Committee on Allied Health Education and Accreditation.

Academic Requirements of OTA Program

For students to remain enrolled in the Occupational Therapy Assistant program, they must:

1. Not receive below a "C" in any course with the OTAT prefix.
2. Maintain a 2.00 GPA in all courses with the OTAT prefix.
3. Obtain an overall GPA of no less than 2.00 prior to the third quarter (spring) of the first year.
4. Maintain at least a 2.00 GPA during each remaining quarter.
5. Successfully complete (with a "D-" or higher) BIOL 101 and 162 by the end of the third quarter (spring) of the first year.

If any of these criteria are not met, the student is dismissed from the OTA program. Conditions for readmission to the OTA program are specified by the chairperson of the department at the time of dismissal.

Clinical Requirements of OTA Program

Clinical placements for the OTA program in the Portsmouth area are limited. OTAT 108, 204, and 208 (Fieldwork 1) are clinical courses requiring six to seven hours, one day per week at the assigned facility. These placements may be up to, and sometimes at distances greater than, 70 miles away from Shawnee State University. Students are responsible for their own transportation to and from these facilities.

OTAT 220 and 221 (Fieldwork 2) consist of two rotations of six to eight weeks each. Students are required to be at that facility during normal working hours (usually 40 hours per week). The OTA program assigns each student two placements. Students are responsible for all expenses incurred to complete the Fieldwork 2 requirements of the OTA program. Students who are dissatisfied with the assigned placements are responsible for finding their own placement which must meet the Fieldwork 2 criteria of the OTA program.

Students are required to have successfully completed all OTAT and other courses in the curriculum (as indicated by a minimum 2.00 GPA) prior to participating in OTAT 220 and 221. OTAT 220 and 221 must be completed within 12 months following completion of other OTA courses.

Occupational Therapy Assistant Curriculum

Course No.	Course	Class Hours	Lab Hours	Credit Hours
FIRST QUARTER (Fall)				
AHNR 102	Medical Terminology	2	0	2
BIOL 101	Introduction to Biology	3	0	3
CISB 101 ¹	Intro. to Computer Information Systems	4	0	4
PSYC 101	Introduction to Psychology	4	0	4
	ARTS 101 or ARTS 231	4	0	4
	Totals	17	0	17
SECOND QUARTER (Winter)				
BIOL 162	Human Anatomy and Physiology	4	3	5
OTAT 101	Introduction to Occupational Therapy	3	3	4
OTAT 102	Therapeutic Media 1	1	6	3
OTAT 108	Practicum 1 (FW1)	1	6	2
PSYC 151	Human Growth and Development	4	0	4
	Totals	13	18	18
THIRD QUARTER (Spring)				
ENGL 111S	Discourse and Composition	4	0	4
OTAT 103	Disease Pathology	4	0	4
OTAT 109	Applied Anatomy and Kinesiology	1	3	2
OTAT 110	Group Dynamics	1	3	2
SOCI 101	Introduction to Sociology	4	0	4
	Totals	14	6	16
FOURTH QUARTER (Summer)				
ENGL 112S	Composition and Research	4	0	4
OTAT 204	Practicum 2 (FW1)	2	6	3
OTAT 205	Therapeutic Media 2	1	6	3
OTAT 210	OTA in Physical Disabilities	4	4	5
	Totals	11	16	15
FIFTH QUARTER (Fall)				
OTAT 203	OTA in Developmental Disabilities	5	3	6
OTAT 206	Contemporary Media in OT	1	3	2
OTAT 208	Practicum 3 (FW1)	2	6	3
PSYC/SOCI	Elective	4	0	4
	Totals	12	12	15
SIXTH QUARTER (Winter)				
EMTP 101 ²	First Aid	2	0	2
OTAT 209	OTA in Geriatric Program Planning	3	3	4
OTAT 211	OTA Seminar	2	0	2
OTAT 212	OTA in Mental Health	3	3	4
SPCH 103	Public Speaking and Human Communication	3	0	3
	Totals	13	6	15
SEVENTH QUARTER (Spring)				
OTAT 220	Clinical Application (FW2)	0	40	6
OTAT 221	Clinical Application (FW2)	0	40	6
	Totals	0	80	12

¹ Due to the high demand for CISB 101, students are strongly encouraged to take this course early in the program.
² Students must have current first aid and CPR certificates prior to starting Clinical Application (OTAT 220 and 221) spring quarter. This may be obtained either through EMTP 101, 102, HPER 227 (for CPR only), or at another agency.

Physical Therapist Assistant

Physical therapist assistants are skilled technical health workers. They work under the supervision of physical therapists to help rehabilitate disabled persons so that they may again lead useful and productive lives. They may use heat, cold, electricity, and exercise for the treatment of patients. The program is designed over a seven-quarter sequence; four quarters include clinical practicums.

Accreditation

The Physical Therapist Assistant program at Shawnee State University is accredited by the Commission on Accreditation in Physical Therapy Education.

Please Note

1. In order to remain in good academic standing in the Physical Therapist Assistant program, a student must receive a "C" (2.0) or better in each course included in the curriculum.
2. Only those students who have been officially accepted into the program or who have received the approval of the department's chairperson may take the courses beginning with the PTAT prefix.

Physical Therapist Assistant Curriculum

Course No.	Course	Class Hours	Lab Hours	Credit Hours
FIRST QUARTER (Fall)				
AHNR 102	Medical Terminology	2	0	2
AHNR 103 ¹	Principles of Medical Science	3	0	3
BIOL 101	Introduction to Biology	3	0	3
ENGL 111S	Discourse and Composition	4	0	4
PTAT 111	Principles of Physical Therapist Assistant	3	0	3
	Totals	15	0	15
SECOND QUARTER				
BIOL 162	Anatomy and Physiology	4	2	5
PTAT 112	Physical Therapist Assistant Procedures 1	3	6	5
PTAT 115	Physical Therapy in Physical Dysfunction	3	0	3
	Totals	10	8	13
THIRD QUARTER				
BIOL 311	Principles of Kinesiology	3	0	3
ENGL 112S	Composition and Research	4	0	4
PSYC 101	Introduction to Psychology	4	0	4
PTAT 113	Physical Therapist Assistant Procedures 2	3	6	5
	Totals	14	6	16
FOURTH QUARTER				
PTAT 114	Anatomy and Kinesiology	3	6	5
PTAT 216	Clinical Practicum Seminar	1	4	2
SOCI 101	Introduction to Sociology	4	0	4
SPCH 103	Public Speaking and Human Communication	3	0	3
	Totals	11	10	14
FIFTH QUARTER				
EMTP 101 ²	First Aid and CPR	2	0	2
PTAT 202	Physical Therapist Assistant Procedures 3	3	6	5
PTAT 212	Clinical Practicum 1	2	12	4

¹ PSCI 105 may be substituted.

² Students must have a current first aid card prior to enrolling in PTAT 214. EMTP 101 is not required if the student has a current first aid card. This can be obtained either through EMTP 101, HPER 227, or another agency.

FIFTH QUARTER (cont'd.)				
PTAT 231	Rehabilitation Procedures 1	2	6	4
PTAT 235	Physical Therapy Trends and Administration	2	0	2
	Totals	11	24	17
SIXTH QUARTER				
PSYC 151	Human Growth and Development	4	0	4
PTAT 213	Clinical Practicum 2	3	3	4
PTAT 232	Rehabilitation Procedures 2	3	3	4
	Elective	4	0	4
	Totals	14	6	16
SEVENTH QUARTER (Spring)				
PTAT 214	Clinical Practicum 3	1	38	6
PTAT 255	PTA Seminar	2	0	2
	Totals	3	38	8

Radiologic Technology

The radiologic technology curriculum prepares the graduate as a radiographer. The radiographer works under the supervision of a medical radiologist or physician in hospital radiology departments, clinics, commercial x-ray laboratories, or doctors' offices. The responsibility of the radiographer is to produce a radiographic (x-ray) image of the highest diagnostic quality of any designated area of the human body. It is from this image that the radiologist makes his or her interpretations.

Curriculum for this program covers eight academic quarters. The first four academic quarters are designed to provide the student with mathematics, basic science, general education courses, supporting technical courses, clinical education, and specialized courses in radiography. The second year of the program consists of additional clinical education scheduled in affiliated hospitals along with advanced radiologic technology courses.

Experience in the radiology departments of the affiliated hospitals provides opportunity for the practical application of knowledge learned in the classroom. This experience in the hospital is a vital part of the program, since it enables the student to assist in the handling of sick and injured patients as they undergo a wide variety of radiographic examinations.

Upon satisfactory completion of the course requirements, the graduate receives the associate in applied science degree and is eligible to apply for examination by the American Registry of Radiologic Technologists.

Accreditation

The Radiologic Technology program at Shawnee State University is fully accredited by the Committee on Allied Health Education and Accreditation of the American Medical Association, in collaboration with the Joint Review Committee on Education in Radiologic Technology.

Academic Requirements

For a student to remain in good standing in the Radiologic Technology program, the following three conditions *must* be met:

1. The student must not receive a grade of "F" in any of the required courses listed in the eight-quarter sequence.
2. The student must not receive a grade below a "C-" in any of the courses with the RDLT prefix.
3. The student must earn an overall grade point average of 2.0 by the end of the third quarter and maintain it throughout the remainder of the program.

If *any one* of these three conditions is not met, the student is academically dismissed from the Radiologic Technology program. Students may apply for readmission to the Radiologic Technology program the following year.

Please Note

1. Only those students who have been officially accepted into the program or who have received the approval of the department's chairperson may take the courses beginning with the RDLT prefix.
2. After the first quarter, all subsequent technical and science courses are closely related and, therefore, must be taken in sequential order. The basic courses (psychology, speech, etc.) may be taken at the student's convenience assuming all prerequisites are satisfied.
3. Students must have a current CPR certification or enroll in EMTA 102.

Radiologic Technology Curriculum

Course No.	Course	Class Hours	Lab Hours	Credit Hours
FIRST QUARTER				
BIOL 101	Introduction to Biology	3	0	3
ENGL 111S	Discourse and Composition	4	0	4
MATH 130	College Algebra 1	4	0	4
RDLT 101	Radiologic Technology 1	2	6	4
	Totals	13	6	15
SECOND QUARTER				
BIOL 310	Human Anatomy	4	3	5
CHEM 121	Introduction to General Chemistry 1	3	3	4
RDLT 102	Radiologic Technology 2	2	10	4
RDLT 200	Basic Patient Care	3	2	3
	Totals	12	18	16
THIRD QUARTER				
CISB 101	Intro. to Computer Info. Systems in Business	2	3	3
ENGL 112S	Composition and Research	4	0	4
RDLT 103	Radiologic Technology 3	3	2	3
RDLT 201	Radiographic Exposure	3	2	4
RDLT 211	Clinical Experience 1	0	16	2
RDLT 312	Sectional Anatomy	2	2	3
	Totals	14	25	19
FOURTH QUARTER				
RDLT 104	Radiologic Technology 4	3	2	3
RDLT 212	Clinical Experience 2	0	24	3
	Totals	3	26	6
FIFTH QUARTER				
RDLT 105	Radiologic Technology 5	3	0	3
RDLT 111	Radiologic Physics	3	2	4
RDLT 213	Clinical Experience 3	0	24	3
SPCH 103	Public Speaking and Human Communication	3	0	3
	Totals	9	26	13
SIXTH QUARTER				
RDLT 106	Radiologic Technology 6	3	0	3
RDLT 112	Radiobiology and Radiation Protection	3	0	3
RDLT 214	Clinical Experience 4	0	24	3
PSYC 101	Introduction to Psychology	4	0	4
	Totals	10	24	13

SEVENTH QUARTER

RDLT 107	Radiologic Technology 7	3	0	3
RDLT 113	Radiographic Processing	2	0	2
RDLT 215	Clinical Experience 5	0	24	3
SOCI 101	Introduction to Sociology	5	0	4
	Communication/Leadership Elective	3-4	0	3-4
	Totals	13-14	24	15-16

EIGHTH QUARTER

RDLT 108	Radiologic Technology 8	2	0	2
RDLT 216	Clinical Experience 6	0	32	4
	Totals	2	32	6

Respiratory Therapy

Respiratory therapy is an allied health specialty, whose practitioners are employed under medical direction to provide treatment, management, diagnostic evaluation, and care to patients with deficiencies or abnormalities associated with the process of breathing.

Respiratory therapists work side-by-side with physicians, nurses, and other health care team members to treat patients ranging in age from premature infants to the elderly. Their duties vary from the administration of oxygen, humidity, and aerosols and the drainage of lung secretions, to the use of technologically sophisticated monitoring devices and treatment techniques in order to assure the survival of patients with life threatening conditions such as head or chest trauma.

Some practitioners choose to spend the majority of their time working in diagnostic laboratories, where they assist in the evaluation of the type and extent of a patient's pulmonary dysfunction and evaluate the effectiveness of the patient's current therapy. Other practitioners may choose to work in specialized areas of respiratory care, including education, management, home care, sales, research, and specialized areas of diagnostic or patient care such as cardiovascular diagnostics or care of infants and children.

Certification

The graduate of the Respiratory Therapy program is eligible to sit for the examinations of the National Board for Respiratory Care. Successful completion of the "entry-level" examination of the NBRC results in the student being awarded the CRTT (Certified Respiratory Therapy Technician) credential. After successful completion of the "entry-level" examination, graduates of this program are eligible to take the "advanced practitioner" examination of the NBRC. Successful completion of that examination results in the student being awarded the RRT (Registered Respiratory Therapist) credential by the NBRC. Successful completion of the entry-level examination also results in graduates being eligible for a license to practice in any state currently having a licensure law.

Accreditation

In 1980 the Ohio Board of Regents approved the creation of this program of study leading to the associate of applied science degree at Shawnee State University. The Respiratory Therapy program at Shawnee State is fully accredited by the Joint Review Committee for Respiratory Therapy Education and the Committee for Allied Health Education and Accreditation of the American Medical Association.

¹ Communication/Leadership Electives: AHNR 102 Medical Terminology, any English course 115S or higher, PSYC 400 Abnormal Psychology, PSYC 375 Educational Psychology, PSYC 273 Human Adjustment, PSYC 151 Human Growth and Development, BMNT 101 Introduction to Business, BMNT 201 Management Concepts, BMNT 202 Personnel Management, BMNT 241 Labor Relations, BMNT 242 Business Communications

Employment Opportunities

Because of the rapid growth of the profession since its inception in the late 1940's, many medical institutions have found that their need for trained respiratory therapy practitioners has exceeded supply. In addition, many clinics, nursing homes, and home care programs are realizing the potential benefits of having a trained respiratory care practitioner on staff. These needs, coupled with the ever-increasing number of cardiovascular disorders being diagnosed, should continue to assure that individuals who enter this profession will enjoy good career opportunities.

Academic Requirements

For a student to remain in good standing in the Respiratory Therapy program, the following three conditions *must* be met:

1. The student must *not* receive a grade of "F" in any of the required courses listed in the curriculum.
2. The student must *not* receive a grade below a "C-" in any course with the RPTT prefix.
3. The student must earn an overall grade point average of 2.00 by the end of the third quarter and maintain it throughout the remainder of the program.

Failure to meet any one of the three stated conditions results in dismissal of the student from the Respiratory Therapy program. Students may apply for readmission to the Respiratory Therapy program the following year after they have successfully completed the required remedial work as detailed by the chairperson of the department at the time of dismissal.

Please Note

1. Only those students who have been officially accepted into the Respiratory Therapy program or have received the approval of the department's chairperson may take courses beginning with the RPTT prefix.
2. After the first quarter, all subsequent technical courses are closely related and, therefore, must be taken in sequential order.

Respiratory Therapy Curriculum

Course No.	Course	Class Hours	Lab Hours	Credit Hours
FIRST QUARTER				
AHNR 102	Medical Terminology	2	0	2
BIOL 101 ¹	Introduction to Biology	3	0	3
RPTT 101	Basic Patient Care	2	3	3
RPTT 102	Cardiopulmonary/Renal Anat. and Phys.	5	0	5
SPCH 103	Public Speaking and Human Communication	3	0	3
	Totals	15	3	16
SECOND QUARTER				
CHEM 121	Introduction to General Chemistry	3	3	4
ENGL 111S	Discourse and Composition	4	0	4
MATH 130	College Algebra 1	4	0	4
RPTT 110	Medical Gas Therapy	3	3	4
RPTT 115	Clinical Application 1	0	8	1
	Totals	14	14	17
THIRD QUARTER				
BIOL 162	Human Anatomy and Physiology	4	3	5
ENGL 112S	Composition and Research	4	0	4

¹ BIOL 151 may be substituted.

THIRD QUARTER (cont'd.)

RPTT 120	Perioperative Care	3	3	4
RPTT 121	Airway Management	1	3	2
RPTT 125	Clinical Application 2	0	8	1
	Totals	12	17	16

FOURTH QUARTER

BIOL 350	Microbiology	4	3	5
RPTT 130	Pediatric and Neonatal Respiratory Care	4	0	4
RPTT 131	Pulmonary Function Testing	2	0	2
RPTT 132	Arterial Blood Gases/Acid-Base	1	0	1
RPTT 133	Laboratory Procedures	0	3	1
RPTT 135	Clinical Application 3	0	16	2
	Totals	11	22	15

FIFTH QUARTER

RPTT 200	Pharmacology	3	0	3
RPTT 201	Continuous Mechanical Ventilation	5	3	6
RPTT 202	Pathophysiology	3	0	3
RPTT 205	Clinical Application 4	0	16	2
¹	General Studies Elective	4	0	4
	Totals	15	19	18

SIXTH QUARTER

RPTT 210	Critical Care	2	0	2
RPTT 211	Advanced Cardiopulmonary Assessment	1	0	1
RPTT 212	Pulmonary Rehabilitation and Home Care	2	0	2
RPTT 213	Department Management	1	0	1
RPTT 215	Clinical Application 5	0	24	3
¹	General Studies Elective	4	0	4
	Totals	10	24	13

SEVENTH QUARTER

RPTT 220	Seminar	4	0	4
RPTT 225	Clinical Application 6	0	40	8
	Totals	4	40	12

Associate of Individualized Studies Degree

The associate of individualized studies degree (AIS) at Shawnee State University is designed to allow students the option of formulating their own individualized program of study. The philosophical basis of the degree is predicated upon the assumption that students may be unable to achieve their personal educational goals through one of the more formalized two-year degree structures offered at Shawnee State. This is especially true for students interested in concentrating or combining a selected mixture of courses encompassing both academic as well as technical offerings in a manner which may not meet the degree requirements of Shawnee State's associate of arts, associate of applied science, or associate of applied business degrees. Students desiring more information concerning this degree should contact the registrar.

¹ General Studies Electives should be selected from the following approved list: ANTH 101 Introduction to Anthropology, any English course not currently required greater than ENGL 115S, PHIL 110 Elements of Symbolic Logic, PSYC 101 Introduction to Psychology, SOCI 101 Introduction to Sociology. Other communication or social science courses may be accepted, with the approval of the department chair.

Center for
Teacher
Education



1993-1995
Shawnee State University

149

Mission of the Center for Teacher Education

Shawnee State University's teacher education program is committed to a curriculum that prepares all its graduates to communicate effectively, to think holistically, and to respond ethically. Combining the breadth of the liberal arts and the depth of an academic discipline with the rigor of a professional development program, Shawnee State's Center for Teacher Education prepares the entry level teacher to meet the dynamic responsibilities of contemporary schools.

Given a complex society where educational activities occur in a variety of settings, professional understanding and skills need to be transferable. Through its policies and practices, the Center models this dynamic professional process by:

1. celebrating the uniqueness, dignity, and worth of each individual;
2. manifesting the relationship of educational practice to appropriate modes of inquiry, styles of learning, and findings of research;
3. promoting collaborative interactions among appropriate agencies; and
4. demonstrating the dynamic balance of continuity and change in educational practice.

Elementary Education Certification

The vision of teaching which guides the teacher education program at Shawnee State University is that of a reflective and inquiring professional. Assuming that teachers continue to develop over time cognitively, technically, and professionally, the program emphasizes dispositions of lifelong learning in addition to the acquisition of specific skills and knowledge.

From the freshman year on, the program's theme of practice-centered inquiry is developed. The combination of the integrated general education core and an in-depth academic major extends the knowledge of a discipline to an understanding of how one learns that discipline. The professional sequence then provides directions for developing instructional strategies and skills to teach the discipline in light of how children learn. The program provides a well articulated, hierarchical arrangement of field and clinical activities, beginning with a set of activities designed to screen students for desired teacher qualities and culminating in student teaching experiences which assess their professional competence and potential.

During their junior and senior years, students engage in the integrative study of core methods. Specified programmatic themes provide interrelatedness not only within the blocks but between and among the other courses in the professional sequence. Foundational studies occur throughout the program and, in fact, serve as a major clarifying and culminating activity. Throughout the program, the emphasis is on structured inquiry and reflection.

The elementary education certification program seeks to lead students to a greater mastery of a teaching specialization, an increased understanding of the liberal arts perspective, a wider context within which to make good choices, a research-based professional education core, and a greater sense of the need to contribute their abilities to the present community through their service and to future communities through their students' lives.

Elementary Education Certification Requirements

1. Apply for and receive admission to the teacher education program.
2. Complete an academic major with an emphasis in elementary education.
3. Demonstrate teaching proficiency and professional competencies throughout the field/clinical experiences and student teaching.
4. Pass the Ohio State Board of Education's Teacher Examination (NTE).

Eligibility Criteria for Admission to the Teacher Education Program

1. Successful completion of at least 45 credit hours of coursework.
2. Cumulative GPA of 2.50.
3. Completion of specified General Education Core courses with a grade of "C" or higher. (See Teacher Education Policy Handbook.)
4. Completion of Professional Education courses with a 3.0 GPA or higher.
5. Completion of Liberal Arts/Sciences major courses with a 3.0 GPA or higher.
6. Successful completion of field experiences.
7. Successful completion of Teacher Education Essay Exams.



Pass/No-Credit Policy

Required courses in the Elementary Education Certification program may not be taken on a pass/no-credit basis.

Course Scheduling

The majority of courses in teacher education are offered during the day. Courses are designed with a field component so that students have an opportunity to apply their knowledge and skills in a school setting throughout the program.

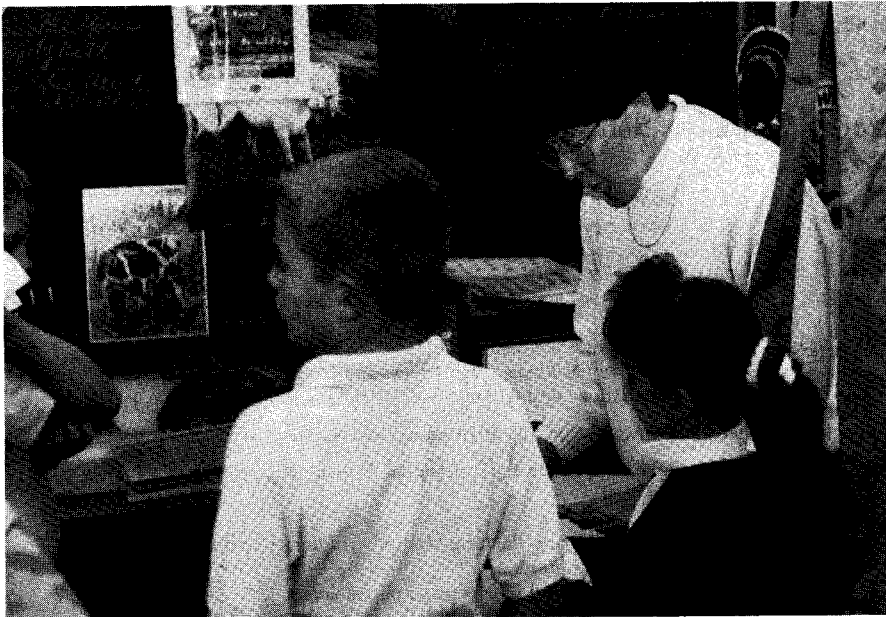

photo by Associate Professor Dauna Lisa Buchanan-Berrigan

Elementary Education Certification Program Curriculum

The requirements for a baccalaureate degree with elementary education certification vary according to the major, but in all cases, in addition to the major selected, all students seeking such certification must complete the courses listed below. Further details, specific to the various majors, are provided on the following pages.

Degree Requirements

General Education Core (50 Hours)

Course No.	Course	Credit Hours
ENGL 111S	Discourse and Composition	4
ENGL 112S	Composition and Research	4
ENGL 115S	Composition and Literature	4
ENGL/HIST 225S	Civilization and Literature 1	4
ENGL/HIST 226S	Civilization and Literature 2	4
ENGL/HIST 227S	Civilization and Literature 3	4
PSCI 110S	Physical Science Core Course	4
SOCI 110S	Foundations of Social Science	4
BIOL 110S	Life Sciences Core Course	4
MATH 110S	Mathematics Core Course	4
PHIL 320S	Ethics in Public and Private Life	4
NTSC 485S	Community Involvement	2
NTSC 490S	Senior Seminar	4

Arts and Sciences Curriculum Content (37 Hours)

Course No.	Course	Credit Hours
ARTS 201	Art in the Elementary Curriculum 1	3
ARTS 202	Art in the Elementary Curriculum 2	3
HPER 202	Personal and Community Health	4
HPER 270	Physical Education for the Elementary Classroom	4
MATH 120	Elementary Topics in Mathematics 1	5
MATH 121	Elementary Topics in Mathematics 2	5
MUSI 160	Fundamentals of Music	3
MUSI 161	Music for the Classroom Teacher	3
PSYC 375	Educational Psychology	4
SPCH 103	Public Speaking and Human Communication	3

Professional Education Requirements (45 Hours)

Course No.	Course	Credit Hours
EDUC 110	Teacher as Inquiring Professional 1: Strategies for Observation and Reflection	2
EDUC 210	Teacher as Inquiring Professional 2: Strategies for Action Research	2
EDUC 220	Social/Physical/Intellectual Growth and Development	3
EDUC 230	Instructional Media, Technology, and Computers	2
EDUC 240	Foundations and Competing Epistemologies 1	2
As a general rule, no 300 or 400 level education courses will be transferred.		
EDUC 310	Teacher as Inquiring Professional 3: Measurement, Diagnosis, and Evaluation	3
EDUC 320	Interdisciplinary Teaching Methods 1: Literacy and Social Studies Education	7
EDUC 340	Foundations and Competing Epistemologies 2	2
EDUC 420	Interdisciplinary Teaching Methods 2: Science and Mathematics Education	7
EDUC 450	Directed Teaching and Seminar	15

Health, Physical Education, and Recreation

The health, physical education, and recreation faculty offer a variety of courses designed to introduce students to psychomotor, cognitive, and affective domains of fitness, leisure, and pre-professional physical education.

Students will develop an understanding of the role physical activity plays in creating a healthy and enjoyable lifestyle. In addition, students will have the opportunity to develop skills related to teaching, coaching, organizing, and administering physical education activities.

As Shawnee State University develops, programs which draw upon the resources of other academic areas and the sports center will be explored.

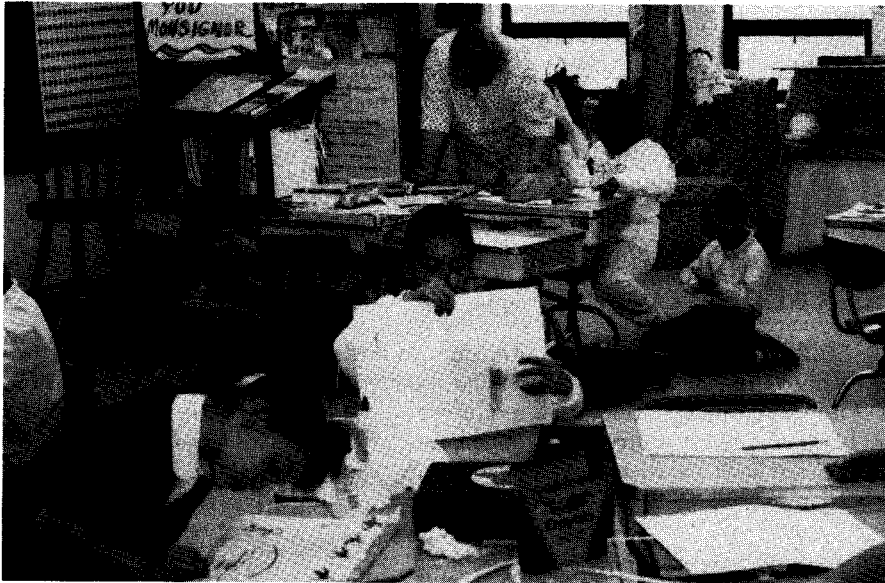

Photo by Associate Professor Dauma Lisa Buchanan-Berrigan

English/Humanities Major with Elementary Education Certification

Degree Requirements

General Education Core (As listed on page 152.)	50 Hours
English/Humanities Courses	68 Hours
Arts and Sciences Requirements (As listed on page 152.)	37 Hours
<i>(NOTE: Students may doublecount 15 hours toward their English/Humanities major)</i>	
Professional Education Requirements (As listed on page 152.)	45 Hours
Total Hours Required for Bachelor of Arts Degree with English/Humanities Major and Elementary Education Certification	200 Hours

English/Humanities Courses (68 Hours)

Area	Hours
Philosophy	4
Introduction to Literature (ENGL 200)	4
Linguistics (ENGL 360/LING 270, ENGL/LING 362 or 365, or ENGL 460)	8
Survey of Literature (ENGL 211, 212, 251, or 252)	8
Shakespeare (ENGL 301 or 302)	4
Theory and Practice in Composition (ENGL 315)	4
Children's Literature	4
Literature After 1800 (ENGL 312, 321, 322, 441, 446, and other suitable courses)	4
American Literature (ENGL 273, 351, 371, 461, 471, and other suitable courses)	4

Literature as Social Perspective (ENGL 341, 342, 343, 344, 346, 349, 383, and other suitable courses)	4
Humanities Electives (Courses must be taken in at least two areas with four hours at the 300 level or higher)	20
Art History	
Music History	
Foreign Language	
Philosophy	
Linguistics (one additional course)	
Other suitable courses as added	

NOTE: Students receiving Elementary Education Certification who started prior to June 1989 may take four hours of linguistics instead of eight. These students may take Literature Before 1800. Students taking only four hours of linguistics must take English 360/LING 270.

Mathematics Major with Elementary Education Certification

Students seeking a bachelor of science in natural science degree who wish to be certified in elementary education must also complete the coursework listed below. It is important to note that these requirements are not entirely in addition to the bachelor of science degree but rather meet certain electives. *Students are urged to work closely with their mathematics advisor and with an advisor from the elementary education program.*

Degree Requirements

General Education Core (As listed on page 152.)	50 Hours
Concentration Area 1 - Mathematics (Any 32 hours of mathematics above MATH 110S. MATH 201 and MATH 305 are required. In addition, at least 9 hours must be numbered 300 or above.)	32 Hours
Concentration Area 2 (To be selected from one science area: biology, chemistry, geology, or physics. Courses must be numbered higher than the core.)	16 Hours
Concentration Area 3 (To be selected from one science area not chosen for Concentration Area 2. Courses must be numbered higher than the core.)	8 Hours
Senior Project in Mathematics (MATH 496 and 497)	4 Hours
Computer Science Elective (To be selected in consultation with a departmental advisor.)	4 Hours
Arts and Sciences Requirements (As listed on page 152.)	37 Hours
Professional Education Requirements (As listed on page 152.)	45 Hours
Total Hours Required for Bachelor of Science Degree in Natural Science with Concentration in Applied Mathematics and Elementary Education Certification	196 Hours

Note: As a general rule, no 300 or 400 level education courses will be transferred.

Natural Science Major with Elementary Education Certification

Students seeking a bachelor of science in natural science who wish to be certified in elementary education must complete the requirements which follow. It is important to note that these requirements are not entirely in addition to the bachelor

of science degree but rather meet certain electives, such as the mathematics requirement, humanities/social science electives, and general electives. Students will have some additional hours to meet all of the requirements. *Students are urged to discuss the elementary education option with their primary advisor in the Department of Natural Sciences and their advisor in the Center for Teacher Education.*

Degree Requirements

General Education Core (<i>As listed on page 152.</i>)	50 Hours
Concentration Area 1 (<i>Biology or chemistry courses above 110 and at least 12 hours above 300 level—32 hours. Senior Project—4 hours</i>)	36 Hours
Concentration Area 2 (<i>Biology, chemistry, geology, physics, or mathematics courses above 110</i>)	16 Hours
Concentration Area 3 (<i>Biology, chemistry, geology, physics, or mathematics courses above 110</i>)	8 Hours
Computer Science Elective	4 Hours
Arts and Sciences Requirements (<i>As listed on page 152.</i>)	37 Hours
(<i>NOTE: Students may doublecount 10 hours toward their science major.</i>)	
Professional Education Requirements (<i>As listed on page 152.</i>)	45 Hours
Total Hours Required for Bachelor of Science Degree in Natural Science and Elementary Education Certification	196 Hours

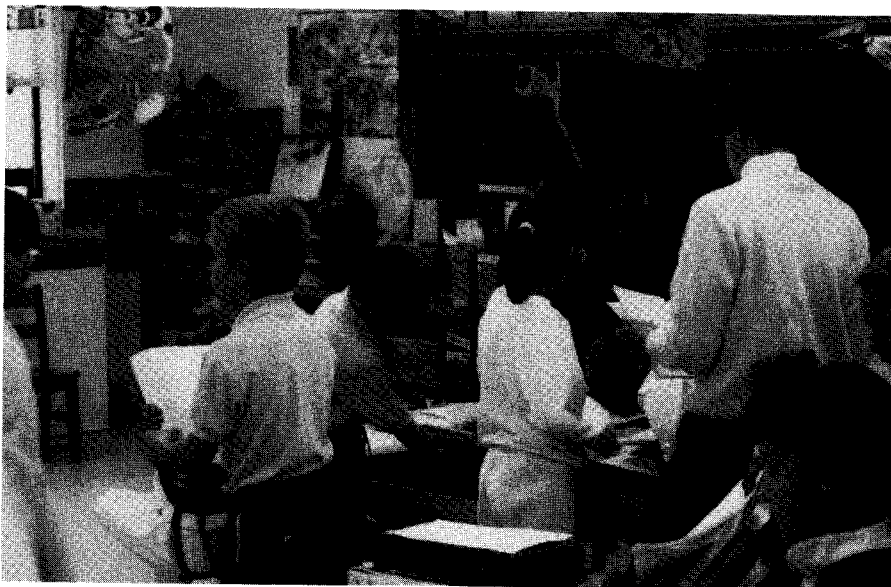

Photo by Associate Professor Dawna Lisa Buchanan-Berrigan

Social Science Major with Elementary Education Certification

Students majoring in social science who wish to complete requirements toward certification in elementary education may choose a special program which was designed to meet their needs. In this curriculum, social science majors take courses which cover subject matter traditionally taught as social studies in the elementary school. Students must achieve a minimum grade of "C" in each required social science course in order to graduate.

Students choosing elementary education certification are urged to work closely with their social science advisor and with an advisor from the elementary education program.

Degree Requirements

General Education Core (<i>As listed on page 152.</i>)	50 Hours
Social Science Requirements	60 Hours
Arts and Sciences Requirements (<i>As listed on page 152.</i>)	37 Hours
Professional Education Requirements (<i>As listed on page 152.</i>)	45 Hours
Total Hours Required for Bachelor of Arts Degree with Major in Social Science and Elementary Education Certification	192 Hours

Social Science Requirements (60 Hours)

Course No.	Course	Credit Hours
ECON 101	Principles of Economics 1 (or ECON 102)	4
GEOG 125	World Geography (or GEOG 201 or GEOG 225)	4
GOVT 250	Introduction to Political Science	4
GOVT 401	State of the World	4
HIST 111	American History to 1828	4
HIST 112	American History, 1828-1900	4
HIST 113	American History Since 1900	4
HIST 201	Ancient History (or HIST 202 or HIST 203)	4
PSYC 101	Introduction to Psychology	4
PSYC 273	Psychology of Human Adjustment	4
PSYC 310	Child Psychology (or PSYC 316)	4
SOCI 101	Introduction to Sociology	4
SOCI 310	Gender Socialization	4
	Social Science Electives	8

Explanation of Prerequisites

Most learning beyond basic skills is dependent upon mastery of some prior skill or subject content. As a result, many courses at the University require the satisfaction of prerequisites prior to course enrollment. Prerequisites may be met by successful completion of the prior courses listed or by placement, via testing, into the course.

The academic division/college may withdraw a student from a course for which prerequisites have not been satisfied.

Explanation of Abbreviations

The abbreviations listed are found throughout the course descriptions on the following pages. In addition, it should be noted that some upper level courses are not included on these pages. Students should contact their faculty advisor for further information.

ACCT — Accounting	HUMN — Humanities
ADNR — Associate Degree Nursing	JOUR — Journalism
AHIS — Art History	LAST — Legal Assisting
AHNR — Allied Health/Nursing	LING — Linguistics
AISM — Automated Information Systems Management	MATH — Mathematics
ANTH — Anthropology	MGNT — Management
ARTS — Art	MLTC — Medical Laboratory Technology
BADM — Business Administration	MRKT — Marketing
BAFT — Banking and Finance	MUSI — Music
BIOL — Biology	NTSC — Natural Science
BMNT — Management	OADM — Office Administration
BUSL — Business Law	OTAT — Occupational Therapy Assistant
CHEM — Chemistry	OTST — Occupational Therapy
CISB — Computer Information Systems in Business	PHAR — Pharmacy
DTHY — Dental Hygiene	PHIL — Philosophy
ECON — Economics	PHYS — Physics
EDUC — Education	PSCI — Physical Science
EMTP — Paramedic	PSYC — Psychology
ENGL — English	PTAT — Physical Therapist Assistant
ESL — English as a Second Language	RDLT — Radiologic Technology
ETCA — Computer Aided Drafting and Design	REST — Real Estate
ETCO — Engineering Technology Core	RMMT — Retail Management
ETEC — Electrical/Computer Engineering Technology	RPTT — Respiratory Therapy
ETEG — Engineering Graphics	SBMT — Small Business Management
ETEM — Electromechanical Engineering Technology	SOCI — Sociology
ETIN — Instrumentation Technology	SPAN — Spanish
ETPL — Plastics Engineering Technology	SPCH — Speech
ETRO — Robotics	THAR — Theater
FINA — Finance	UNIV — University
FREN — French	
GEOG — Geography	<i>Preq.</i> — Prerequisite
GEOL — Geology	<i>Coreq.</i> — Corequisite
GOVT — Government	
HIST — History	The following abbreviations denote the quarter in which the course is normally offered:
HPER — Health, Physical Education, and Recreation	<i>Su</i> — Summer
	<i>F</i> — Fall
	<i>W</i> — Winter
	<i>Sp</i> — Spring

ACCT 101 Accounting 1 (4) Introduction to fundamental accounting concepts and procedures. The accounting cycle: nature of accounts and techniques of recording, classifying, summarizing, and analyzing basic financial data. Application of fundamental accounting techniques to partnerships and corporations. Accounting for the formation, operation, and dissolution of business enterprises. *F W Sp; preq. A;; required developmental courses must be completed.*

ACCT 102 Accounting 2 (4) Application of fundamental accounting techniques for cash, long term investments, notes and accounts, inventory methods, plant and equipment, and liabilities. Introduction to manufacturing operations, cost methods, and management's need of cost data. *W Sp Su; preq. ACCT 101*

ACCT 103 Accounting 3 (4) Reporting and analyzing financial data. Financial statement introduction, analysis, and interpretation to meet the needs of modern management. Introduction to accounting techniques applicable to parent and subsidiary companies and departmental and branch operations. Budgeting as an aid to management and the importance of income tax considerations in financial decisions. *Sp Su; preq. ACCT 102*

ACCT 110 Payroll Records/Accounting (3) A basic course in the maintenance of personnel and payroll records as required by the Fair Labor Standards Act and the various federal and state laws covering the withholding and payment of payroll related taxes. *Sp Su; preq. ACCT 101 or 201*

ACCT 201 Financial Accounting Principles (4) An introduction to the concepts and principles underlying financial accounting theory. The study includes the accounting equation and its application to the business entity. Procedures and concepts in accumulating and reporting financial information are developed. (Not open to students who have completed ACCT 101 and 102.) *F W; preq. ECON 101, 102, and sophomore standing*

ACCT 203 Managerial Accounting (4) A study of the financial information needs of management for decision making. Includes the development of financial statements for manufacturing entities, the study of the components of unit cost, variable costing, and cost-volume-profit analysis. *W Sp; preq. ACCT 201*

ACCT 215 Tax Accounting (4) Current income tax law and regulations related to business and individual income tax reporting. Practice in preparation of tax returns of businesses and individuals. *Sp Su; preq. ACCT 103 or 203*

ACCT 221 Cost Accounting 1 (4) Introduction to cost accounting systems and methods. Cost concepts, classifications, and measurement techniques in relation to their importance in determination, planning, and control. Job order and process cost accounting methods. *F; preq. ACCT 103 or 203*

ACCT 222 Cost Accounting 2 (4) Estimating, planning, and controlling the costs of processes and projects. Standard cost accounting procedures and the analysis of variances. Cost and profit responsibility reporting to management. Uses of cost and profit data in project selection, product pricing, and other functions of management. *W; preq. ACCT 221*

ACCT 231 Intermediate Accounting 1 (4) A more advanced treatment of accounting theory; determination of income realization and cost expiration. Primary emphasis is on asset accounts in order listed on the balance sheet. *F; preq. ACCT 103 or 203*

ACCT 232 Intermediate Accounting 2 (4) Continuation of ACCT 231 with emphasis on the balance sheet sections dealing with investments, fixed assets, and liabilities. *W; preq. ACCT 231*

ACCT 233 Intermediate Accounting 3 (4) Continuation of ACCT 232 with detailed study of the owner's equity section of the balance sheet and the financial statements presentation and analysis. *Sp; preq. ACCT 232*

ACCT 250 Accounting Projects 1 (1-4) A special course designed to permit the accounting student to work on special projects under the supervision of an instructor with expertise in the area of the student's project. The special projects course will enable the accounting student to apply the accounting theory as covered in other courses. *Not regularly offered; preq. departmental permission (see accounting advisor).*

ACCT 261 Accounting with D. P. Applications 1 (4) Application of basic accounting procedures to the microcomputer. Emphasizes applications to the IBM microcomputer system. *Not regularly offered; prep. ACCT 103 and CISB 101*

ACCT 299 Special Topics 1 (1-4) Opportunity for accounting students to continue their study of accounting in specialized areas under the supervision of an instructor with expertise in those areas. *Not regularly offered; prep. departmental permission (see accounting advisor); see special note on page 84.*

ACCT 305 Governmental Accounting (4) A basic introduction to the accumulation and use of accounting information in non-profit organizations. General principles applying to budgets and funds are examined rather than specific application. An especially useful course for non-accounting (and accounting) students who will be employed in governmental units where budgeting and accounting are required. *W Su; prep. ACCT 231 or 103 or 203 and permission*

ACCT 311 Accounting Projects—Advanced (1-4) A special course designed to permit the advanced accounting student to work on special projects under the supervision of an instructor with expertise in the area of the student's project. The special projects course will enable the accounting student to apply the accounting theory as covered in other courses. *Not regularly offered; prep. ACCT 233 and departmental permission.*

ACCT 330 Industrial Accounting (4) Study of the use of data by management in planning and controlling business operations. Emphasis on the solution of problems confronting management by the use of accounting information in analytical form. Not recommended for associate degree accounting majors. *W; prep. ACCT 103, 203, or permission*

ACCT 360 Systems Accounting (4) A course in accounting information systems principles and applications. The application of accounting principles to computerized environment, including transaction processing and internal controls, revenue and expenditure cycle applications, software systems, and computer security. *F; prep. AISM 101 and ACCT 103 or ACCT 203 and permission*

ACCT 410 Health Care Accounting/Administration (4) The use of accounting information in planning and controlling the operations of health care organizations. Budgeting and the specialized cost accounting applications of health care organizations are included. *Not regularly offered; prep. ACCT 103 or ACCT 203 and permission.*

ACCT 435 Auditing (4) Independent audits, professional ethics, legal liability, internal control, auditing standards, work sheet applications and procedures. Concern is given to audit evidence, the auditor's approach and techniques, summary reports, statistical sampling, and role of advisory services to management. *Sp; prep. ACCT 222, 233, and permission*

ACCT 499 Special Topics—Advanced (1-4) Opportunity for the advanced accounting student to continue the study of accounting in a specialized area of accounting under the supervision of an instructor with expertise in the area. *Not regularly offered; prep. departmental permission (see accounting advisor); see special note on page 84.*

SPECIAL NOTE—ADNR (Associate Degree Nursing): *Only students officially accepted into the nursing program or those with approval of the program director may take the courses with the ADNR prefix. All ADNR courses must be taken in sequence.*

ADNR 101 Nursing 1—Fundamentals 1 (8) Introduction to the nursing process system enabling students to assist individuals to meet daily living needs. Fundamental skills and related scientific principles of nursing are presented. Laboratory practice provides the opportunity to develop beginning skills in both technical and interpersonal aspects of nursing. *F; 5 lec. 9 lab*

ADNR 102 Nursing 2—Fundamentals 2 (8) Continuing development of basic nursing skills. A beginning study of medical-surgical nursing concepts relevant to all age groups. Emphasis on application of all components of the nursing process. *W; prep. 2.0 average or better in courses required for fall quarter of first year; 5 lec. 9 lab*

ADNR 103 Nursing 3—Nursing of Adults and Children 1 (8) Focuses on implementing the nursing process in meeting basic needs of the adult or child experiencing stressors related to safety and security, activity and rest, and sexual role satisfaction. Further development of technical skills. *Sp; req. 2.0 average or better in courses required in winter quarter of first year; 4 lec. 12 lab*

ADNR 201 Nursing 4—OB Maternal/Newborn Nursing (5) Applies the nursing process in the study of the normal aspects of the maternal cycle and the normal newborn infant. Common recurring stressors related to the maternal/newborn cycle are presented. Skills needed to provide family-centered nursing in normal and stress situations are introduced. *F W; 6 lec. 12 lab (may be five-week course)*

ADNR 202 Nursing 5—Mental Health and Illness (5) Presents concepts of mental health and selected deviant emotional and mental responses to stress. Encourages increased self-awareness and development of beginning skills in the use of self. Application of the nursing process in providing nursing care for clients with specific behavior patterns. *F W; 6 lec. 12 lab (may be five-week course)*

ADNR 203 Nursing 6—Trends (2) Concerns of nursing—past, present, and future—are explored. Discussion of the relationship of the technical nurse to health professions and community, personal development of the individual, and legal and ethical implications for nursing practice. *F W*

ADNR 204 Nursing 7—Nursing of Adults and Children 2 (10) Applies the nursing process in caring for adults and children experiencing stressors affecting oxygen transport and fluids and electrolytes balance. *F W; 6 lec. 12 lab*

ADNR 205 Nursing 8—Nursing of Adults and Children 3 (9) Systematically applies the nursing process in caring for groups of patients. Synthesizes previous knowledge for utilization of the nursing process with adult and child clients experiencing stressors affecting nutrition and elimination. *Sp; 4 lec. 15 lab*

ADNR 211 Nursing 9—Nursing Seminar (3) A theoretical and practical approach to setting nursing priorities. Discussion of the transition from student role to graduate role as a member of the health team. *Sp*

ADNR 299 Nursing Special Topics (1-3) Individual or small-group study, under the supervision of an instructor, of topics not otherwise available to students.

AHIS 101 Introduction to Art (4) Beginning study of the nature and purposes of art as seen both in historical and contemporary works (primarily for non-art majors).

AHIS 261 Art History Survey 1 (Prehistoric through Roman) (4) Covering Paleolithic, Egyptian, Near Eastern, Aegean, Greek, Etruscan, and Roman art. *F W*

AHIS 262 Art History Survey 2 (Medieval through Renaissance) (4) Study of Early Christian, Byzantine, Romanesque, Gothic, and Renaissance art. *W Sp*

AHIS 263 Art History Survey 3 (Baroque through Modern) (4) Study of Baroque, Neoclassical, Romantic, Realist, Impressionist, Post Impressionist, and Twentieth Century art. *Sp*

AHIS 310 History of Photography (4) Survey of major figures and ideas involved in the evolution of photography as a creative art form.

AHIS 331 Ceramic History Survey 1 (4) Prehistoric to modern non-Asian, including Egypt, Pre-Columbian American, Middle East, Africa, Europe, U.S.A. *Offered on demand*

AHIS 332 Ceramic History Survey 2 (4) Asia, China, Korea, Japan, Vietnam, and India. *Offered on demand*

AHIS 360 Nineteenth-Century Art (4) Study of the visual arts in Europe and America, from Neoclassicism through Postimpressionism, in relation to social and cultural developments of that time.

AHIS 361 Twentieth-Century Art (4) Comparative study of developments in all fields of visual art as expressions of our time.

AHIS 364 North American Survey (4) A survey of American art (colonial through the present). *Offered on demand*

AHIS 366 Non-Western Survey (4) A survey of non-Western art: Asia, China, Korea, Japan, Vietnam, and India. *Offered on demand*

AHNR 100 Pre-Anatomy (4) Students are prepared for anatomy by learning medical roots, muscles, bones, body planes, and medical abbreviations. This is a special course developed primarily for all health science programs.

AHNR 101 Introduction to Health Technologies (2) Introduction to the health professions, including history, responsibilities, and ethics. Includes introduction to the health science programs at Shawnee State University.

AHNR 102 Medical Terminology (2) Introduction to medical terminology commonly used in health occupations. Emphasis is placed on prefixes, suffixes, and building and analyzing medical terms. F

AHNR 103 Principles of Medical Science (3) Basic inorganic, organic, and biochemistry principles as applied to human physiology. Includes principles of physics and the metric system. Specifically designed for students in allied health or nursing programs. *Su F Sp; req. acceptance into one of the health science programs or permission of health science department chair*

AHNR 199 Topics in Health Sciences (1-14) Individual or small group study, under the supervision of an instructor, of topics otherwise not available to students.

AHNR 285 Topics in Health Physics 1 (1-14) Ten (10) course modules of classroom instruction focus on biological effects of radiation, radiation protection standards, regulations/ALARA, respiratory protection, radiological control and monitoring, radiation protection and measurement, atomic and nuclear properties, interaction of radiation with matter, and dosimetry.

AHNR 286 Topics in Health Physics 2 (1-14) A continuation of AHNR 285. Ten (10) course modules of classroom instruction focus on biological effects of radiation, radiation protection standards, regulations/ALARA, respiratory protection, radiological control and monitoring, radiation protection and measurement, atomic and nuclear properties, interaction of radiation with matter, and dosimetry.

AHNR 299 Topics in Health Sciences (1-14) Individual or small group study, under the supervision of an instructor, of topics not otherwise available to students.

AHNR 310 Orientation to Health Care Systems (3) A broad orientation to the health services industry. Segments of the health services industry are identified and described with historical background, functions, interrelationships, and future roles of each. *Required for health management concentration*

AHNR 311 Health Record Principles (3) Study of the health record, including definition, standards for content, and format. Also studied are the interactions of the health care professionals contributing to, utilizing, and analyzing health record data.

AHNR 312 Health Care Personnel Management (3) Principles of health care personnel recruitment, selection, and management. Characteristics of the professional health care worker are discussed. Legal responsibilities, collective bargaining, continuing education, and training are covered.

AHNR 325 Instructing Adults (3) Cross-listed as EDUC 325. Study of adult learning needs and participation patterns. Teaching styles and techniques best suited to adults are analyzed and demonstrated.

AHNR 327 Methods of Teaching in Health and Occupations (3) Cross-listed as EDUC 327. The subject matter and teaching methodologies of health instruction in classrooms, laboratories, and community settings are analyzed and demonstrated.

AHNR 402 Community Health Education (3) Cross-listed as EDUC 402. Philosophy of community health education with emphasis on historical, conceptual, and legal precepts.

AHNR 410 Patient Care in Long-Term Health Care Facilities (3) An overview of the total medical and social care required for residents of long-term health care facilities. The student is oriented and exposed to the various aspects required of the administrator and institution to provide for the total care of the individual. Topics include pharmaceutical services, disease process and recognition, biological aging, and psychology of patient care, patient assessment, care planning, and nutrition.

AHNR 411 Administration in Long-Term Care Facilities (3) The role and responsibility of management as applied to a long-term health care facility. The expectations for the administrator are identified and discussed relative to ethical practices, licensure, state and federal agency requirements, and financial management.

AHNR 420 Problems in Health Care Management and Policies (3) A seminar course where health care management problems are studied and recommendations offered for the resolution of those problems. *It is recommended that this problems and policy course be taken as the last course in the 24-hour health management concentration.*

AHNR 430 Health Care Finance and Reimbursement (3) Financial aspects of health care management, including income projections, budgeting, and analysis of financial statements. Reimbursement plans and types of health insurance are investigated. *Prq. ACCT 101 and 102*

AHNR 451 Internship in Health Management/Education (1-6) Cross-listed as EDUC 451. Health care management/education experience is obtained in selected institutions or agencies related to the student's health management/education interest and ability. Written reports are required. *Prq. approval from the dean of the College of Health Sciences.*

AHNR 461 Research Problems in Health and Recreational Education (3) Cross-listed as EDUC 461. Exploration of research methodologies, issues, and problems peculiar to health professions.

AHNR 495 Special Topics (2-4) Cross-listed as EDUC 495. Provides students an opportunity to gain additional knowledge or experience in a specific area or field.

AISM 101 Introduction to Automated Information Systems (4) A study of computer history, systems, concepts, applications, and social implications. Laboratory activities include basic microcomputer operation and introduction to popular software packages. *Su F W*

AISM 103 Computer Applications (4) Hands-on study in the use of microcomputer software packages, including word processing, spreadsheets, data base management, business graphics, data communications, and integrated packages. *Su F W Sp; prq. AISM 101 or CISB 101*

AISM 299 Special Topics in Automated Information Systems 1 (1-4) Opportunity for the student to work on special projects under the supervision of an instructor with expertise in the area of the student's project. *Not regularly offered; prq. instructor permission; see special note on page 84.*

AISM 310 Data Base Management (4) Data base system design, implementation, and access using a relational data base and fourth generation programming language. Laboratory project required. *Sp; prq. AISM 103 or CISB 204 or advisor permission for OADM majors.*

AISM 320 Systems Analysis and Design (4) The study and methodology of how computer information systems are developed and implemented successfully. Discussion of the role of the systems analyst in contrast to the programmer analyst. CASE tools and structured analysis and design techniques are studied. *F; prq. AISM 103 or CISB 204*

- AISM 430 Information Systems Development Project (4)** The use of micro-computers and applications software to design, construct, and implement a complete operational information system, including organizing and loading the data base and use of the system to generate appropriate outputs. *Not regularly offered; preq. AISM 310 and 320*
- AISM 499 Special Topics in Automated Information Systems 2 (1-4)** Opportunity for the advanced student to work on special projects under the supervision of an instructor with expertise in the area of the student's project. *Not regularly offered; preq. instructor permission; see special note on page 84.*
- ANTH 101 Introduction to Anthropology (4)** An introduction to the biological nature of humans. The roots of primate and hominid evolution, speciation, cultural beginnings, and the processes of evolution in modern humans are examined. *W*
- ANTH 199 Topics in Anthropology (1-4)** Individual or small-group study, under the supervision of instructor, of topics not otherwise available to students.
- ANTH 250 Principles of Cultural Anthropology (4)** How humans have adapted as foragers, hunters, farmers, and industrialists. The diversities of pre-literate and living human societies, social structure, kinship, religion, and ecology are examined in cross-cultural settings. *Sp*
- ANTH 299 Special Topics in Anthropology (1-4)** Individual or small-group study, under the supervision of instructor, of topics not otherwise available to students. Separate courses repeatable for credit.
- ANTH 340 MesoAmerica Before Columbus (4)** Survey of MesoAmerican settlement prior to the arrival of the Europeans, including origins of the first hunters and gatherers, development of agriculture, Olmec and Zapotec civilizations, rise and fall of Teotihuacan, and settlement and influence of Mayans, Toltecs, and Aztecs up to the arrival of the Spanish.
- ANTH 360 Indians of North America (4)** Description and analysis of traditional native American cultural areas and impact of modern society on native Americans. *Preq. ANTH 250*
- ANTH 371 Islamic Religion, Culture, and Civilization (4)** Survey of the cultural legacy of Islam through an integrated look at the religion, social customs, economic practices, arts, and literature. *W*
- ANTH 399 Topics in Anthropology (1-4)** Individual or small-group study, under the supervision of instructor, of topics not otherwise available to students.
- ARTS 101 Studio Foundations 1 (4)** An entry-level class focusing on the dynamics of black and white, two-dimensional media. It provides students with methods of seeing, visualizing, and expressing themselves on paper. Required of all students with art concentration. *F W Sp*
- ARTS 102 Studio Foundations 2 (4)** An entry-level class which focuses on the use and perception of color. Discussion of various color systems. Color exercises based on theory and historic contexts. Required of all students with art concentration. *W*
- ARTS 103 Studio Foundations 3 (4)** An entry-level course devoted to the concepts and use of three-dimensional materials used in sculptural terms. Required of all students with art concentration. *Sp*
- ARTS 104 Terminology, Tools, and Materials in Graphic Design (4)** Course designed to make students familiar with the "building blocks" used by graphic designers. Hands-on experience with many of the tools used in this profession. Emphasizes the basics of using T-squares, triangles, and technical pens. Demonstrates modern graphic computers. Introduces the many types of materials involved such as rubber cement, acetate, and papers. *F W*

ARTS 105 The Creative Process (4) Team-taught and interdisciplinary. Examines the creative process in all the arts via lectures, demonstrations, visiting artists, and films. Special emphasis is given to artists' statements about themselves and the role of the arts in the development of civilization. *Sp*

ARTS 201 Art in the Elementary Curriculum 1 (3) First of two art courses required of those wishing to become certified as elementary teachers in Ohio. The emphasis of these two courses (201 and 202) is to teach the teacher to become a creative coach or a catalyst in the child's artistic growth. Emphasis is on understanding, facilitating, and integrating art into the elementary curriculum. *F W Sp; preq. EDUC 110*

ARTS 202 Art in the Elementary Curriculum 2 (3) Continuation of ARTS 201. *F W Sp; preq. ARTS 201*

ARTS 205 Graphic Design Reproduction Techniques (4) A course designed to familiarize the graphic design student with the various methods of reproducing the finished art work. Discussion of various methods of printing, color separation, and electronic media. Lectures, demonstrations, field trips, and studio work are included. *F W*

ARTS 210 Photography 1 (4) An introduction to the art and techniques of photography. Student must provide 35mm camera. *Su F W Sp*

ARTS 211 Photography 2 (4) Continued exploration of photographic techniques. Student must provide 35mm camera. *Su F W Sp; preq. ARTS 210*

ARTS 212 Photography 3 (4) Continuation of ARTS 211. Student must provide 35mm camera. *Su F W Sp; preq. ARTS 211*

ARTS 215 Photography for the Graphic Designer (4) An introduction to the basic knowledge of photography for the graphic designer, covering the basics of setting up, lighting, and designing photo compositions. *Offered on demand*

ARTS 221 Painting 1 (4) A focus on individual expression through the use of oil and acrylic painting mediums. *Su F W Sp; preq. ARTS 101, 102, or permission*

ARTS 222 Painting 2 (4) Continuation and expansion of ideas developed in ARTS 221. *Su F W Sp; preq. ARTS 221*

ARTS 223 Painting 3 (4) Extension of the concepts developed in ARTS 222. *Su F W Sp; preq. ARTS 222*

ARTS 231 Ceramics 1 (4) Entry-level course focusing on the use of clay in creating hand built pottery and forms. Basics of glazing work are covered. *F W Sp*

ARTS 232 Ceramics 2 (4) Entry-level course focusing on the use of the potter's wheel to create basic thrown forms. *F W Sp*

ARTS 233 Ceramics 3 (4) Concentration on the combination of hand built and wheel thrown forms and further study of glaze techniques. *F W Sp; preq. ARTS 231 and 232*

ARTS 238 Wood Design 1 (4) This course explores the basis for using wood as a design/sculpture medium. Initial understanding of tool use and safety practices is the focal point of this first class. *F W*

ARTS 239 Wood Design 2 (4) Extension of ARTS 238. Students having a solid background in the use of woodworking tools concentrate on achieving aesthetic/artistic results in their individual design projects. *F W*

ARTS 240 Wood Design 3 (4) Extension of ARTS 239. Promotes further exploration of the medium. *W Sp*

ARTS 241 Sculpture 1 (4) Course designed to develop the student's ability to conceive and build three-dimensional forms in various media (plaster, clay, wood, and metal). Understanding of shapes and mass, acquaintance with tools, techniques, and materials for expression. *F W Sp*

ARTS 242 Sculpture 2 (4) Intermediate sculpture course designed to further a student's skill in three-dimensional work. Technical procedures include advanced woodcarving, clay molding, stone carving, and various direct over armature methods. *F W Sp; req. ARTS 241*

ARTS 243 Sculpture 3 (4) Studio problems based on concepts applied to various three-dimensional materials. Advanced sculpture places special emphasis on the development of individual expression in the student's chosen medium. *F W Sp; req. ARTS 242*

ARTS 244 Introduction to Printmaking (4) A studio course utilizing basic techniques in relief printing and screen printing. *Offered on demand*

ARTS 245 Intaglio (4) Introduction to basic intaglio techniques. Emphasis on mastering techniques used to develop personal imagery. *Offered on demand; req. ARTS 101 and 102*

ARTS 246 Lithography (4) An introduction to basic lithographic technique and printing. Emphasis is placed on mastering techniques used to further personal aesthetic goals. *Offered on demand; req. ARTS 101 and 102*

ARTS 247 Screen Printing (4) An introduction to basic silk screen techniques. Emphasis is on mastering techniques used to develop personal imagery. *Su F W Sp; req. ARTS 101 and 102*

ARTS 248 Relief Printing (4) An introductory course employing the range of graphic possibilities in the relief printing process. *Offered on demand; req. ARTS 101 and 102*

ARTS 251 Typography for the Graphic Designer (4) Studio course beginning with some basic background in type design and theory and working through its use in modern graphic design. Use of transfer lettering, type sizing, and specifications in graphic design. *Offered on demand*

ARTS 252 Basic Illustration (4) Studio course beginning with design basics and integrating these basics into illustration techniques for the graphic designer. Black and white graphics and color techniques. *F W Sp; req. ARTS 251*

ARTS 253 Illustration (4) Extension of ARTS 252. The instructor helps the student develop a portfolio. *Offered on demand; req. ARTS 251 and 252*

ARTS 271 Life Drawing 1 (4) Drawing from a model in black and white media. Repeatable for credit—maximum of two quarters. *Su F W Sp; req. ARTS 101 or permission*

ARTS 272 Life Drawing 2 (4) Continuation of ARTS 271. Repeatable for credit—maximum of two quarters. *Su F W Sp; req. ARTS 271*

ARTS 273 Life Drawing 3 (4) Continuation of ARTS 272. Repeatable for credit—maximum of two quarters. *Su F W Sp; req. ARTS 272*

ARTS 275 Drawing Workshop 1 (4) Extension of ARTS 101 and 102. Focus is on developing drawing skills (perspective, composition, etc.) through the use of colored pencils and advanced black and white media. *Su F W Sp; req. ARTS 101 and 102*

ARTS 276 Drawing Workshop 2 (4) Continuation of ARTS 275. Students are expected to demonstrate increased facility and conceptualization. *Su F W Sp*

ARTS 277 Drawing Workshop 3 (4) A continuation of concepts developed in ARTS 275 and ARTS 276. *F W Sp; req. ARTS 276*

ARTS 290 Weaving 1 (4) Introduction to weaving techniques through the construction and use of a simple loom and the use of the table or floor loom. *Offered on demand*

- ARTS 292 Fabric Design 1 (4)** Printing and dyeing fabric as well as applying design to cloth. F W Sp
- ARTS 293 Fabric Design 2 (4)** Continuation of ARTS 292. F W Sp; *preq.* ARTS 292
- ARTS 294 Fabric Design 3 (4)** Continuation of ARTS 293. F W Sp; *preq.* ARTS 293
- ARTS 299 Topics in Art (1-4)** Opportunity for the student to plan and complete a project which meets with the approval of the staff member supervising this arranged course. Repeatable for credit. Su F W Sp; *preq. permission of staff*
- ARTS 303 Elementary Art Methods (4)** Focus is on implementing studio techniques with the elementary student. *Offered on demand*
- ARTS 304 Secondary Art Methods (4)** The aesthetic rationale and hands-on methodology of teaching art in the upper grades. Included are: studio projects, history, appreciation, and theory.
- ARTS 310 Intermediate Photography 1 (4)** Continuation of ARTS 212 utilizing more advanced dark room and camera techniques. Su F W Sp; *preq.* ARTS 212
- ARTS 311 Intermediate Photography 2 (4)** Utilizes techniques taught in ARTS 310 with emphasis on artistic growth in the medium. Su F W Sp; *preq.* ARTS 310
- ARTS 312 Intermediate Photography 3 (4)** Utilizes techniques taught in ARTS 311. Individualizes instruction promoting continued artistic growth in the medium. Su F W Sp; *preq.* ARTS 311
- ARTS 321 Intermediate Painting 1 (4)** Oil and acrylic painting used to extend concepts developed in earlier painting courses. Individual concepts highly stressed. Su F W Sp; *preq.* ARTS 223
- ARTS 322 Intermediate Painting 2 (4)** Su F W Sp; *preq.* ARTS 321
- ARTS 323 Intermediate Painting 3 (4)** Su F W Sp; *preq.* ARTS 322
- ARTS 324 Watercolor 1 (4)** Series of courses which focuses on the use of transparent watercolors to extend personal imagery. Su F W Sp; *preq.* ARTS 101, 102, or *permission*
- ARTS 325 Watercolor 2 (4)** Continuation of ARTS 324. Su F W Sp; *preq.* ARTS 324
- ARTS 326 Watercolor 3 (4)** Continuation of ARTS 325. Su F W Sp; *preq.* ARTS 325
- ARTS 327 Figure Painting 1 (4)** Painting the human figure from a model in oil or acrylic. F W Sp; *preq.* ARTS 223
- ARTS 328 Figure Painting 2 (4)** Continuation of ARTS 327. F W Sp; *preq.* ARTS 327
- ARTS 329 Figure Painting 3 (4)** Continuation of ARTS 328. Emphasis on individual style and technique as opposed to strictly objective rendering. F W Sp; *preq.* ARTS 328
- ARTS 331 Intermediate Ceramics 1 (4)** Intermediate hand built techniques, including use of clay and glazes. A continuation of ARTS 231. F W Sp; *preq.* ARTS 231
- ARTS 332 Intermediate Ceramics 2 (4)** Intermediate throwing techniques, including decorative techniques. F W Sp; *preq.* ARTS 232 and 233
- ARTS 333 Intermediate Ceramics 3 (4)** A continuation of concepts developed in ARTS 331 and ARTS 332. F W Sp; *preq.* ARTS 332
- ARTS 334 Raku Ceramics (4)** Introduction to the philosophy and techniques of the traditional Japanese ceramic ware called "Raku." Sp; *preq.* ARTS 231, 232, and 233
- ARTS 335 Porcelain Ceramics (4)** For advanced students of the potter's wheel. History, use, and glazing of porcelain. W; *preq. permission of staff*

ARTS 336 Glaze Theory and Practice (4) Understanding of the many standard types of ceramic glazes. *F*

ARTS 338 Mold Making (4) History and development of ceramic mold making. Techniques to be addressed: bisque molds, press molds, sprigging, jigger and jolley processes, casting, ram pressing, and plaster technology.

ARTS 341 Intermediate Sculpture 1 (4) Techniques of sculptural expression in the "additive" mode: clay, wax, found elements. *F W Sp; preq. ARTS 243*

ARTS 342 Intermediate Sculpture 2 (4) Experience with low and high relief sculpture in "subtractive" processes: carving and sandblasting in glass, clay, wood, stone, plastics. *F W Sp; preq. ARTS 341*

ARTS 343 Intermediate Sculpture 3 (4) Relief and small full-round sculpture by casting processes: soft metals, plaster, plastics. *F W Sp; preq. ARTS 342*

ARTS 345 Intermediate Intaglio (4) Continuation of ARTS 245. Intermediate level techniques in etching and plate production combined with use of printing papers in producing an individualized image. *Offered on demand; preq. ARTS 245*

ARTS 346 Intermediate Lithography (4) Continuation of ARTS 246. Individual styles and techniques in lithography and advances by understanding more advanced methods of register paper ink use. *Offered on demand; preq. ARTS 246*

ARTS 347 Intermediate Screen Printing (4) Continuation of ARTS 247. Introduction of new techniques in manual and photo screen print production. *Offered on demand; preq. ARTS 247*

ARTS 371 Intermediate Life Drawing 1 (4) Working from a model developing a unique personal approach to drawing. Repeatable for credit—maximum of two quarters. *Su F W Sp; preq. ARTS 101*

ARTS 372 Intermediate Life Drawing 2 (4) Continuation of ARTS 371. Repeatable for credit—maximum of two quarters. *Su F W Sp; preq. ARTS 101*

ARTS 373 Intermediate Life Drawing 3 (4) Continuation of ARTS 372. Repeatable for credit—maximum of two quarters. *Su F W Sp; preq. ARTS 101*

ARTS 375 Intermediate Drawing Workshop 1 (4) Development of a personal style of expression in two-dimensional drawing mediums. *Su F W Sp*

ARTS 376 Intermediate Drawing Workshop 2 (4) Continuation of ARTS 375. *Su*

ARTS 399 Topics in Art (2-4) Opportunity for the student to plan and complete a project which meets with the approval of the staff member supervising this arranged course. Repeatable for credit. *Su F W Sp; preq. permission of staff*

ARTS 410 Advanced Photography 1 (4) Advanced techniques in individualized areas such as lighting, color, and photographing the figure. *F W Sp; preq. ARTS 312*

ARTS 411 Advanced Photography 2 (4) Continuation of ARTS 410. *W Sp; preq. ARTS 410*

ARTS 412 Advanced Photography 3 (4) Continuation of ARTS 411 and presentation of senior portfolio. *Sp; preq. ARTS 411*

ARTS 421 Advanced Painting 1 (4) *F W Sp; preq. ARTS 326*

ARTS 422 Advanced Painting 2 (4) *F W Sp; preq. ARTS 421*

ARTS 423 Advanced Painting 3 (4) Focus on helping the artist develop a coherent/cohesive body of work (developing an individual style). *F W Sp; preq. ARTS 422*

ARTS 424 Advanced Watercolor 1 (4) Continuation of ARTS 326 with more emphasis on individual style and use of more advanced materials such as special papers, etc. *Su F W Sp; preq. ARTS 326*

ARTS 425 Advanced Watercolor 2 (4) Continuation of ARTS 424 with a widening dialog of expression based on individual style. Combined with experiments in the medium. *Su F W Sp; preq. ARTS 424*

ARTS 426 Advanced Watercolor 3 (4) Continuation of ARTS 425 combined with a presentation of senior portfolio. *Su F W Sp; preq. ARTS 425*

ARTS 427 Advanced Figure Painting 1 (4) Painting from a model in oil or acrylic. *F W Sp; preq. ARTS 329*

ARTS 428 Advanced Figure Painting 2 (4) Painting from a model in oil or acrylic. *F W Sp; preq. ARTS 427*

ARTS 429 Advanced Figure Painting 3 (4) Continuation of ARTS 428. Considerable progress in a personal style is encouraged with emphasis on using the human form as a basis for advanced work. *F W Sp; preq. ARTS 428*

ARTS 434 Advanced Raku (4) Continuation of ARTS 334. The Raku philosophy as applied to modern and western forms. *Offered on demand; preq. permission of staff*

ARTS 435 Advanced Porcelain (4) Continuation of ARTS 335. Commercial and self-formulated porcelain applied to larger works. *Offered on demand; preq. permission of staff*

ARTS 436 Advanced Glaze Theory and Practice (4) Continuation of ARTS 336. Compounding and testing of self-designed glazes. *Offered on demand; preq. ARTS 336*

ARTS 441 Advanced Sculpture 1 (4) Techniques of casting in full-round, high-temperature, "harder" metals (bronze, aluminum) using the *cire perdue* process. *F W Sp; preq. ARTS 343*

ARTS 442 Advanced Sculpture 2 (4) Emphasizes personal expression and the development of style in combinations of the foregoing technical processes. *F W Sp; preq. ARTS 441*

ARTS 443 Advanced Sculpture 3 (4) Continuation of personal development. Introduction to land art, monument art, environment art, happenings, performance art. *F W Sp; preq. ARTS 442*

ARTS 475 Advanced Drawing Workshop (4) Continuation of ARTS 376. *Su F W Sp*

ARTS 476 Advanced Drawing Workshop (4) Continuation of ARTS 475. *Su F W Sp*

ARTS 480 Senior Studio 1 (4) This course (and ARTS 481) must be taken the senior year in the area of the student's concentration. *Arranged time. Offered on demand*

ARTS 481 Senior Studio 2 (4) This course must be in the area of the student's concentration. *Arranged time. Offered on demand; preq. ARTS 480*

ARTS 499 Topics in Art (2-4) Opportunity for the student to plan and complete a project which meets with the approval of the staff member supervising this arranged course. Repeatable for credit. *Su F W Sp; preq. permission of staff*

BADM 485S Community Involvement (Core Course) (2) Community Involvement is an outgrowth of the purposes and objectives of the University. The series of activities integral to the Community Involvement course enhance the education of the student, complement the senior seminar, and promote reflection on the student's obligation to human beings in need and society at large. *(not offered summer quarter)*

BADM 490S Senior Seminar (Core Course) (4) This course provides an opportunity for students to place their chosen field of study in an interdisciplinary context with intellectual, ethical, and historical perspectives. The seminar focuses on the synthesis and integration of various concepts by applying them to the analysis and solution of problems chosen in the context of their academic disciplines. Oral and written presentations of the seminar paper are required. *Preq. senior standing and 44 core hours*

BAFT 101 Principles of Banking and Finance (4) Monetary standards, commercial and central banking. Federal Reserve functions and statements, monetary and income theory, problems of monetary and fiscal stabilization, international payments, and the International Bank and Monetary Fund. *F*

BAFT 102 Introduction to Commercial Lending (4) An overview of the commercial lending function. Four sections cover commercial lending overview, the lending process, portfolio management, and regulation and business development. Specific contents include the commercial loan customer, types of commercial loans, the loan decision process, cost analysis, control and profitability, and the regulatory and legal environment. *W*

BAFT 105 Installment Credit (4) Procedures, forms, government regulations, delinquency and collections, interest rates, background of installment credit. *W*

BAFT 106 Principles of Bank Operations (4) Basic course stating a history of banking, developing of Federal Reserve System; three main duties, safekeeping, transfer of funds, lending. Examination and governmental examination. Field work and problems concerning the operation of commercial bank and savings and loan institutions. *Sp*

BAFT 202 Home Mortgage Lending (4) A course covering the basic principles of home mortgage lending. A study of the procedures used from the opening to closing of mortgages. A complete study of all necessary forms, rules, and regulations the buyer should know in obtaining a loan. *Not regularly offered.*

BAFT 204 Introduction to Investments (4) A study of the various types of investments, including stocks, bonds, mutual funds, commercial paper, options, and commodities. Particular emphasis is given to return and risk in developing investment strategies. *F*

BAFT 299 Special Topics in Banking (1-4) Opportunity for the student to work on special projects under the supervision of an instructor with expertise in the area of the student's project. *Not regularly offered; preq. instructor permission; see special note on page 84.*

BIOL 099 Fundamental Biology (4) Designed for students with an inadequate background in biological science or those students with no high school biology who plan to enter one of the allied health programs. Material presented is intended to increase familiarity with terms and chemical processes. *Su F W Sp*

BIOL 101 Introduction to Biology (3) An introduction to basic concepts of biology for allied health and nursing students. *F W*

BIOL 110S Life Sciences Core Course (4) Students have the opportunity to gain familiarity with the characteristics of life on earth, consider physiological and anatomical features of their own body systems, analyze examples of the impact of biologic phenomena on the individual and society, and apply the scientific method. *F W Sp; 2 lec. 2 discussion/activity*

BIOL 151 Principles of Biology (5) Introduction to principles and concepts of life; emphasis on interrelationships of structural, functional, reproductive, evolutionary, and ecological principles related to cells and organisms. *Su F; 3 lec. 4 lab*

BIOL 162 Human Anatomy and Physiology (5) A general survey of the structure and function of the human body. Not applicable for students requiring BIOL 310 and BIOL 320. *W Sp; preq. BIOL 101 or 151; 4 lec. 2 lab*

BIOL 170 Field Biology (4) An introduction to basic life processes including the structure and function of plants and animals. Laboratory emphasis is on the identification and natural history of local flora and fauna, with special attention to trees and shrubs. *Sp even years*

BIOL 202 Principles of Plant Biology (5) Anatomy and morphology of seed plants are related to the functional aspects of photosynthesis, growth, transport, and reproduction. Practical emphasis on plant/man interactions. Brief survey of plant kingdom with focus on life histories and evolutionary relationships. *Sp; preq. BIOL 151; 3 lec. 4 lab*

BIOL 203 Principles of Animal Biology (6) Principles of animal taxonomy, structure, function, development, and behavior. Laboratory survey of major phyla. *W; preq. BIOL 151; 4 lec. 4 lab*

BIOL 210 Taxonomy of Vascular Plants (4) Principles of classification of extinct and extant seed plants with emphasis on family recognition. Collection, identification, and preservation of seed plants. *W odd years; 3 lec. 3 lab*

BIOL 212 Forestry Management and Practices (4) Investigation of the development and the existing practices of modern forestry in the U. S. Basic management practices are discussed with laboratory exercises designed to improve forest management skills. *Offered on demand; preq. BIOL 110S and 202; 3 lec. 2 lab*

BIOL 220 Wildlife Management (4) A study of ecological principles of the management of wild animals, both game and non-game species. The economic importance of wildlife and the role of various wildlife agencies are also considered. *Offered on demand; preq. BIOL 110S or permission; 3 lec. 2 lab*

BIOL 260 Neurobiology of Behavior (4) Basic neurology, neurophysiology, and neuropharmacology, with emphasis on how they relate to human behavior. *Sp; preq. BIOL 110S and PSYC 101*

BIOL 271 Field Ornithology (4) A study of the classification, adaptation, and habitat requirements of birds with particular emphasis on Ohio species. Field identification is emphasized in lab. *Sp odd years; 3 lec. 3 lab*

BIOL 272 Ohio's Natural Heritage (3) An exploration of the natural history of Ohio. Arranged field trips visit all five of Ohio's physiographic regions. *Sp even years; 2 lec. 3 lab arranged*

BIOL 290 Seminar in the Life Sciences (1-4) Discussion of advanced topics in the life sciences.

BIOL 295 Independent Study (1-4) Independent life science investigation under the direction of a faculty member. *Su F W Sp*

BIOL 302 Dendrology (4) Collection, identification, nomenclature, classification, and ecological relationship of native, introduced, and cultivated woody plants. *As needed; 2 lec. 4 lab*

BIOL 303 Spring Flora (4) Identification, nomenclature, and classification of spring flowering plants. Origin and evolution of flora in Ohio. *Sp even years; 2 lec. 4 lab*

BIOL 307 General Entomology (5) An introduction to the morphology and classification of insects. The major orders, families, and species of economic importance, both beneficial and pest, are emphasized. Students collect and identify local species. *F as needed; 2 lec. 6 lab*

BIOL 310 Principles of Anatomy (5) An introduction to morphology of tissues and systems of the human body. *W Sp; preq. BIOL 101 or 151; 4 lec. 3 lab*

BIOL 311 Kinesiology (4) Concentration on skeletal and muscle systems and their functional interplay in the analysis of motion. *Sp; preq. BIOL 162 or 310; 3 lec. 2 lab*

BIOL 312 Sectional Anatomy (3) An introduction to sectional human anatomy. *Sp; preq. BIOL 162 or 310; 2 lec. 2 lab*

BIOL 314 Human Neuroanatomy (5) A detailed anatomy of the human nervous system with attention to functional and clinical considerations. Students complete a brain dissection and view prosected human spinal cord. Students are assessed by lab practicals and written exams. *W; preq. BIOL 162 or 310; 4 lec. 2 lab*

BIOL 315 Histology (5) Study of the microscopic structure of cells, tissues, and organ systems and their physiological properties. *F; preq. BIOL 310; 4 lec. 2 lab*

BIOL 320 Principles of Physiology (5) An introduction to human systems physiology. *F Sp; preq. BIOL 310*

BIOL 321 Human Physiology Lab (2) Laboratory designed to complement BIOL 320. Exercises illustrate basic physiological principles and techniques, with emphasis on the human. *Preq. or Coreq. BIOL 320; 4 lab*

BIOL 330 Ecology (4) A study of the interrelationships among the many elements in an environment. A historical approach to the concept of evolution, man's impact upon the environment, and common ecological problems faced by society. Labs introduce common and basic ecological techniques. *W; preq. BIOL 202; 3 lec. 3 lab*

BIOL 331 Advanced Field Biology (4) Examination of the principles and techniques of biological field investigation. *Offered on demand; preq. BIOL 330; 2 lec. 4 lab*

BIOL 340 Genetics (5) Principles and concepts of genetics as revealed by classical and modern investigation. Transmission, molecular, and population genetics are examined. *F; preq. BIOL 151*

BIOL 341 Genetics Lab (2) Experiments and experiences designed to illustrate principles of genetics. *F; preq. or coreq. BIOL 340; 4 lab*

BIOL 350 Microbiology (5) A survey of representative types of microorganisms. Emphasis is placed on cellular structure and physiology, nutritional, and environmental requirements and methods of reproduction. Introduction to the role of pathogenic organisms in diseases. Principles of immunity and resistance to disease. Laboratory includes methods of sterilization, culture staining, and identification. *Su F; preq. BIOL 101 or 151; 4 lec. 3 lab*

BIOL 351 Microbiology Lab (1) Additional laboratory experience for the student intending to major in the life sciences. Introduces student to media preparation, collection of lab data, and its graphic interpretation. *Offered on demand; preq. or coreq. BIOL 350; 3 lab*

BIOL 360 Plant Anatomy and Morphology (5) Detailed study of vascular plant anatomy and morphology considered from an evolutionary viewpoint. Labs involve study of anatomy and morphology of all major vascular plant groups, extinct and extant. *Offered on demand or by arrangement; preq. BIOL 202; 2 lec. 4 lab*

BIOL 365 Phycology (4) An introduction to the taxonomy, morphology, evolution, and ecology of terrestrial, freshwater, and marine algae. Practice in identifying local species. *W odd years; preq. BIOL 151; 2 lec. 4 lab*

BIOL 370 Marine Biology (5) An introduction to marine biology, including the areas of oceanography and ecology. All biological principles are infused into discussions with marine themes. *W; preq. BIOL 110S or 151; 4 lec. 2 lab*

BIOL 390 Seminar in Life Sciences (1-4) Discussion of advanced topics in life sciences. *Preq. junior or senior standing*

BIOL 395 Special Topics in Biology (1-4) Individual or small-group study, under the supervision of instructor, of topics not otherwise available to students. *Preq. BIOL 110S*

BIOL 407 Diagnostic Microbiology (5) Diagnostic procedures for the recovery and identification of medically important bacteria and fungi. Emphasis is on the morphological, cultural, biochemical, and serological characteristics of various pathogenic bacteria and fungi. *Sp; preq. BIOL 350; 3 lec. 6 lab*

BIOL 410 Advanced Human Anatomy (5) A regional approach to the anatomy of the human body utilizing cadaver dissection. *W even years; preq. BIOL 310 or 162; 3 lec. 4 lab*

BIOL 411 Biochemistry (4) Cross-listed as CHEM 411. General principles of the structural and functional properties of carbohydrates, lipids, nucleic acids, and proteins. This course can be counted as a concentration area in biology or chemistry. *Sp odd years; preq. CHEM 307; 4 lec.*

BIOL 432 Cell Biology (5) Current survey of the structure and function of eukaryotic and prokaryotic cells, including recent advances in molecular biology and tissue culture technique. *F even years; preq. BIOL 151 and CHEM 122 or 142*

BIOL 450 Immunology (4) Study of antigen and antibodies with emphasis on in vivo and in vitro reactions, including recent information in immunogenetics and monoclonal strategies. *Preq. BIOL 350*

BIOL 470 Plant Physiology (5) A general introduction, including plant/soil, plant/water relationships, mineral nutrition, photosynthesis, and growth integrated with related aspects of biophysics. *W even years; preq. BIOL 202 and 360; 3 lec. 3 lab*

BIOL 485 Senior Project (1-4) In-depth study of a selected topic in the life sciences, culminating in the preparation of a senior paper. *Su F W Sp; preq. junior or senior standing*

BIOL 490 Seminar in the Life Sciences (1-4) Discussion of advanced topics in the life sciences. *preq. junior or senior standing*

BIOL 495 Undergraduate Research (1-4) Independent life science investigation under the direction of a faculty member. *Su F W Sp; preq. junior or senior standing*

BIOL 499 Special Topics in Life Science (1-4) Individual or small-group study, under the supervision of instructor, of topics not otherwise available to students.

BMNT 101 Introduction to Business (4) A survey course of the basic functions of American business with an emphasis on the responsibility of business as a vital segment of society. Introduction to the American economic system and the role of profits as the motivating force behind U.S. business activity. (Not open to juniors and seniors.) *F W Sp*

BMNT 102 Marketing Concepts (4) A study of marketing fundamentals, consumption, consumer behavior, retailing, wholesaling structures, the functions performed in marketing, marketing policies, and a critical appraisal of the field of marketing. *F W*

BMNT 201 Management Concepts (4) An introductory course in management concepts, organization, and principles with a detailed analysis of the management functions of planning, organizing, staffing, directing, and controlling. Communications, decision making, and motivation are emphasized as integral concepts in performing the management functions. *F W Sp*

BMNT 202 Personnel Management (4) The philosophy, principles, and methods of personnel management stressing human resource planning, recruiting, selection, placement, training, evaluation, wage and salary administration, and benefit programs. *F W Sp*

BMNT 241 Labor Relations (4) Topics related to collective bargaining, contract or labor agreements, workers' compensation laws, apprentice training, and jurisdictional disputes. *W*

BMNT 242 Business Communications (4) Principles and techniques of effective letter writing, letter mechanics, writing of personal business letters, including application letters, methods of writing business reports and letters, and internal and external reports as a means of communication. *F W Sp*

BMNT 299 Special Topics in General Business (1-4) Opportunity for the student to work on special projects under the supervision of an instructor with expertise in the area of the student's project. *Not regularly offered; preq. instructor permission; see special note on page 84.*

BUSL 250 Business Law 1 (4) An introduction to the legal environment of business based on the uniform commercial code, including the forms and classifications of law, an overview of the court systems, court procedure, social forces and the law, torts and crimes, and the principles of contract law. *F W Sp*

BUSL 260 Business Law 2 (4) Includes the study of the law covering sales, agency and employment, commercial paper, personal property, and bailments. *W Sp*

BUSL 270 The Legal Environment of Business (4) An examination of the creation and evolution of principles and rules of law, emphasizing an understanding of the court system and court procedure, the role of administrative agencies and government regulations, and the study of criminal, tort, and the substantive law of contracts. *Sp*

BUSL 299 Special Topics in Legal Environment (1-4) Opportunity for the student to work on special projects under the supervision of an instructor with expertise in the area of the student's project. *Not regularly offered; preq. instructor permission; see special note on page 84.*

CHEM 101 Fundamental Chemistry (4) A course designed for students with an inadequate background in chemistry or students who have not had high school chemistry. Topics and material presented are intended to increase student's familiarity with the periodic table, chemical processes, and chemical calculations. *Su F W Sp; preq. one year of high school algebra or MATH 101*

CHEM 121 Introduction to General Chemistry 1 (4) An introductory course in fundamental concepts of chemistry for nonscience majors. Topics include atomic structure, compound formation, chemical equations, stoichiometry, inorganic nomenclature, and gas laws. Credit allowed for only one of these introductory courses: CHEM 101, 121, or 141. Recommended for students requiring only one year of chemistry. *F W; preq. one year of high school chemistry or CHEM 101 or successful completion of MATH 130; 3 lec. 3 lab*

CHEM 122 Introduction to General Chemistry 2 (4) An introduction to the properties of solutions, reactions in solution, acids and bases, equilibrium oxidation-reduction reactions, and nuclear chemistry. Credit not allowed for both CHEM 122 and 142. *W Sp; preq. CHEM 121 or permission; 3 lec. 3 lab*

CHEM 141 General Chemistry 1 (4) An introduction to chemistry through the study of fundamental chemical concepts, atomic structure, periodic classification, mole concept, stoichiometry with problem solving, chemical bonding, and nuclear chemistry. Credit not allowed for both CHEM 121 and 141. *F W; preq. one year of high school chemistry or CHEM 121 and placement in MATH 130; 3 lec. 3 lab*

CHEM 142 General Chemistry 2 (4) An introduction to states of matter, chemical reactions in water solutions, properties of liquids and solutions, and nuclear chemistry. Credit not allowed for both CHEM 122 and 142. *W Sp; preq. CHEM 122 or 141 and placement in MATH 130 or above; 3 lec. 3 lab*

CHEM 143 General Chemistry 3 (4) An introduction to chemical thermodynamics and kinetics, acid-base theory, ionic equilibria, electrochemistry, coordination compounds, and qualitative analysis. *F Sp; preq. CHEM 142 and placement in MATH 131 or above; 3 lec. 3 lab*

CHEM 200 Introduction to Organic Chemistry (4) A course in fundamental organic chemistry. The study of the major functional groups: saturated and unsaturated hydrocarbons, alcohols and ethers, aldehydes and ketones, carboxylic acids, amines, carboxylic acid derivatives. The organic chemistry of carbohydrates, lipids, and proteins. *Sp*; *preq.* CHEM 121 or 141; 3 lec. 3 lab

CHEM 223 Quantitative Analysis (5) An introduction to methods of chemical analysis by classical, gravimetric, and volumetric techniques. Colorimetry and potentiometry with emphasis on solution equilibria and stoichiometric calculations. *W*; *preq.* CHEM 143 and MATH 132; 3 lec. 6 lab

CHEM 240 Introduction to Environmental Science (4) Cross-listed as NTSC 240. Survey of the nature and scope of environmental problems. Emphasis on the physical, biological, and human aspects of environmental science. *Sp*; *preq.* *sophomore standing with coursework in the basic sciences, BIOL 151, CHEM 143, or GEOL 201*; 3 lec. 2 lab

CHEM 305 Organic Chemistry 1 (4) A course for science majors wishing to acquire a sound knowledge of classical and modern organic chemistry. Credit not allowed for both CHEM 200 and 305. *F*; *preq. or coreq.* CHEM 143; 3 lec. 3 lab

CHEM 306 Organic Chemistry 2 (4) Continuation of CHEM 305. *W*; *preq.* CHEM 305; 3 lec. 3 lab

CHEM 307 Organic Chemistry 3 (4) Continuation of CHEM 305 and 306. *Sp*; *preq.* CHEM 306; 3 lec. 3 lab

CHEM 325 Instrumental Analysis (5) An introduction to methods of chemical analysis by spectrophotometric, spectrographic, chromatographic, and electrometric techniques. *Sp*; *preq.* CHEM 223; 3 lec. 6 lab

CHEM 331 Introduction to Physical Chemistry (4) Survey of thermodynamics, kinetics, gas laws, quantum mechanics, and spectroscopy. *F*; *preq.* PHYS 213 or permission

CHEM 341 Introduction to Inorganic Chemistry (4) Survey of periodic table, bonding theories, etc. *Preq.* CHEM 307; *preq. or coreq.* CHEM 331; 4 lec.

CHEM 411 Biochemistry (4) Cross-listed as BIOL 411. General principles of the structural and functional properties of carbohydrates, lipids, nucleic acids, and proteins. This course can be counted as a concentration area in biology or chemistry. *Sp odd years*; *preq.* CHEM 307; 4 lec.

CHEM 432 Physical Chemistry 1 (4) Topics include equilibrium, liquids, solids, spectroscopy, etc. Application of experimental principles to lecture theory. A bridge course between chemistry and physics. *W*; *preq.* CHEM 331; 3 lec. 3 lab

CHEM 433 Physical Chemistry 2 (4) Topics include thermodynamics, kinetics, quantum mechanics, and areas of recent research advances (e.g. semiconductors). *Sp*; *preq.* CHEM 432; 3 lec. 3 lab

CHEM 485 Senior Project (1-4; maximum 4) In-depth study of a selected topic in chemistry, culminating in the preparation of a senior paper. *F W Sp*; *preq. senior standing and instructor permission*

CHEM 490 Seminar in Chemistry (1-4; maximum 4) Study of a specific advanced topic in chemistry. *Preq. junior or senior standing and instructor permission*

CHEM 495 Undergraduate Research (1-4; maximum 9) Independent chemistry investigation under the direction of a faculty member. A written report is required. *Preq. senior standing, 2.75 grade point average in chemistry, and instructor permission*

CHEM 499 Special Topics in Chemistry (1-4) The study of topics not otherwise available to students.

CISB 101 Introduction to Computer Information Systems (4) Computer theory presented via lectures as well as practical hands-on experiences in a work setting. Introduction to topics such as computer history, hardware, software, and business applications. Instruction in the use of computer software, including the DOS operating system, word processing, spreadsheets, data base management, and beginning BASIC programming. *Su F W Sp*

CISB 103 BASIC Language 1 (4) Introduction of topics such as principles of computer programming, flowcharts, pseudocode, and algorithm development. Students learn beginning advanced concepts in the BASIC language and write functional programs in a hands-on work environment. *Su F W Sp; preq. CISB 101*

CISB 104 BASIC Language 2 (4) Advanced BASIC programming techniques. Students learn how to optimize file creation and access. *Sp; preq. CISB 103*

CISB 105 COBOL Programming 1 (4) In-depth study of the COBOL language. Use of files on disks, print routines, terminals, and documentation. Many problems are assigned to move theory into practice. *F; preq. CISB 101*

CISB 106 COBOL Programming 2 (4) A deeper study of COBOL. More complex problems using tables and various utility programs available from the manufacturer; new instructions and different ways of using them. *W; preq. CISB 105*

CISB 201 C Language (4) Introduction to Microsoft QUICK C programming. Engineering and business programs are assigned and programmed. Arrays and pointers are introduced and mastered. *F Sp; preq. one computer language course or sophomore standing.*

CISB 202 Computer Operations Management (3) Personnel policies, computer management procedures, equipment acquisition, and management of resources related to data processing. Basic management principles to effectively manage a computer system, computer personnel, and resources. *W; preq. two programming languages and sophomore standing*

CISB 203 Business Computer Projects (4) Research projects are assigned on both an individual and group basis. Students learn to function in a group setting as they conduct research related to the assigned topics. Theoretical systems concepts are explored in the classroom. A formal presentation is required. *W; preq. sophomore standing*

CISB 204 Microcomputer Applications (4) Advanced topics and techniques of several popular business application software packages. Word processing, spreadsheets, and data base management tools are utilized. *W; preq. CISB 101*

CISB 205 Business Data Systems and Communications (3) A study of modern data communication systems, including theory of telecommunications and communications software. Emphasis on networking and LANs. Laboratory project. *Sp; preq. one computer language and sophomore standing*

CISB 206 Fortran 77 (4) A basic course in FORTRAN, including FORTRAN arithmetic, formats, loops, arrays, program flow charting, testing, debugging, and documentation. The student is assigned several programs to solve statistical mathematics and business problems. *F; preq. one computer language*

CISB 207 PASCAL Language (4) An introduction to the programming language PASCAL. Some knowledge of basic algebra is helpful. Use of Input/Output statements, loops, subprograms, arrays, and files. This course is recommended for the natural science degree. *Sp*

CISB 208 RPG II Language (4) A computer language normally used to produce reports for management. All rules of programming apply, but various forms are required to produce output. *Sp; preq. sophomore standing*

CISB 299 Special Topics in Computer Information Systems in Business (1-4) Opportunity for the student to work on special projects under the supervision of an instructor with expertise in the area of the student's project. *Not regularly offered; preq. instructor permission; see special note on page 84.*

DTHY 101 Radiology 1 (2) Didactic instruction in dental radiology. Topics include: characteristics of radiation, components and functions of the x-ray machine, and x-ray production. Emphasis on exposure factors and their effects on radiographs, effects of radiation exposure, and radiation protection. Dental x-ray films and film processing are also covered. *W*

DTHY 102 General and Oral Histology and Embryology (3) Study of the development of tissues and structures from a histological and embryological basis. Emphasis on development of tissues of the teeth and the periodontal supporting structures. *W; req. BIOL 101*

DTHY 103 Nutrition (3) The principles of basic human nutrition with emphasis on nutritional diets and their relation to general and oral health. The study of valid nutritional information and healthful food selection. *F*

DTHY 111 Oral Anatomy 1 (3) A study of tooth form, function, and occlusion, including the supporting tissues of the teeth and oral environment. Emphasis on dental vocabulary, terminology, and the relationship of the permanent and deciduous dentition to clinical dental hygiene. *F*

DTHY 112 Oral Anatomy 2 (2) Detailed study of the anatomy of the head and neck. Topics include facial bones, muscles of the head and neck, nerve supply, and blood supply. Detailed study of the topographical and functional anatomy of the oral cavity and pharynx. *W*

DTHY 113 Radiology 2 (2) Continuation of DTHY 101. Emphasis on radiographic technique through lecture and lab experiences. Lab experiences include bisection of the angle and paralleling techniques as well as extra-oral radiographs on training models. Students process and mount film, as well as learn to recognize processing and technical errors, normal anatomical landmarks, and pathology. *Sp; req. DTHY 101*

DTHY 121 Clinical Dental Hygiene 1 (4) Introduction to the profession and history of dental hygiene. The principles of preventive dentistry regarding etiology of deposits, caries, inflammation, and oral physiotherapy methods. Aseptic techniques are outlined. Basic instrumentation principles are demonstrated on typodonts followed by demonstration on partners. *F*

DTHY 122 Clinical Dental Hygiene 2 (4) Continuation of DTHY 121. Clinical skills include intra/extra oral examinations, dental/periodontal charting, scaling and polishing techniques, periodontal probing, and fluoride techniques. Skills are transferred from typodont to partner. *W*

DTHY 123 Clinical Dental Hygiene 3 (4) Continuation of DTHY 122. Techniques for dental hygiene care are performed in clinical patient treatment. Advanced skills include desensitization techniques, instrument sharpening, sequencing and planning patient treatment, and methods of motivating to prevent oral disease. *Sp*

DTHY 201 General and Oral Pathology (3) An introduction to pathology. Discussion of processes of inflammation, necrosis, retrograde changes, and wound healing. Etiologies, diagnosis, treatment, and prognosis of oral lesions. Pathology of diseases affecting teeth and their supporting structures. *F; req. BIOL 101 and 162*

DTHY 202 Periodontics (3) A study of the periodontal supporting structures of the teeth. Etiologies and classifications of periodontal disease are discussed. The treatment of periodontal disease is discussed in relation to the etiologies. *Sp*

DTHY 203 Dental Materials (3) Didactic and laboratory instruction on the physical properties of materials used in dentistry. Basic principles of the preparation and use of certain restorative materials, impression materials, and laboratory procedures, including chemical sealants, preliminary impressions, and study models. *Su*



DTHY 204 Pharmacology and Anesthesiology (3) Drugs and anesthetics used and encountered in dentistry. Discussion of the origin, physical and chemical properties, effects on body systems, indications and contraindications for use, and methods of administration and elimination. *W; preq. AHNR 103 or CHEM 121*

DTHY 205 Dental Health Education (3) Analysis of goals for the development of dental health education programs. Major emphasis is on preparation and use of lesson plans and instructional materials for teaching groups. Involves classroom instruction of dental health in public schools. *Su*

DTHY 206 Public Health (3) An introduction to the broad field of public health with emphasis on dental public health. A basic approach for designing and implementing a public dental health program to promote dental health and prevent dental diseases in the community. *W*

DTHY 220 Oral Microbiology/Immunology (3) A study of general microbiology as applied to oral disease and immunity. An in-depth study of ecology of the oral flora in health and disease. Applied microbiology principles are used in topics of sterilization and asepsis. *Sp; preq. BIOL 101 and 162*

DTHY 224 Clinical Dental Hygiene 4 (5) Continuation of DTHY 123. Techniques and procedures of dental hygiene care and services performed in the clinic atmosphere as they would be in practice. Lecture topics concern medical emergencies in the dental office. *Su*

DTHY 225 Clinical Dental Hygiene 5/Special Needs (5) Continuation of DTHY 224. Dental hygiene clinical practice includes applied nutrition as it relates to current concepts in preventive dentistry for the dental hygienist. *F*

DTHY 226 Clinical Dental Hygiene 6/Preventive Dentistry and Jurisprudence (5) Continuation of DTHY 225 with emphasis on prevention and trial state board patients. Ethics, jurisprudence, state laws, malpractice, and professional organizations are discussed as they relate to the dental hygiene profession. Career placement is investigated. *W*

DTHY 227 Clinical Dental Hygiene 7/Career Management (5) Continuation of DTHY 226. Complete dental hygiene care involving the use of advanced skills and techniques learned in previous dental hygiene courses. Special needs patients are discussed. Selected topics through seminars and lectures are presented to aid professional growth. *Sp*

DTHY 290 Seminar in Advanced Periodontics (1-3) Current concepts regarding nonsurgical treatment of periodontal disease. Major emphasis is placed on assessment of root planing techniques and maintenance and care of patients with periodontal disease. *Su; preq. DTHY 202 or permission of the program director*

ECON 101 Principles of Economics 1 (4) An introduction to the elementary principles of macroeconomics. Includes a study of the economic system and an analysis of national income concepts, fiscal and monetary policies, and economic growth. *Su F W Sp*

ECON 102 Principles of Economics 2 (4) An elementary analysis of the principles of microeconomics. Includes a study of consumer behavior, different types of products and resource markets, and an analysis of certain economic problems. *F W Sp*

ECON 301 Intermediate Microeconomics (4) A study of the economic theories of the consumer and the firm. Analysis of price and output behavior under various product and market structures and resource market analysis. *W even years; preq. ECON 101 and 102*

ECON 302 Intermediate Macroeconomics (4) National income analysis; fiscal and monetary policies for economic stabilization. *W odd years; preq. ECON 101 and 102*

ECON 310 Money and Banking (4) Cross-listed as FINA 310. Development of banking and the role of the Federal Reserve system in the U.S. Analysis of monetary policy for purpose of stabilization. *F odd years; preq. ECON 101 and 102*

ECON 325 Economic History of the U.S. (4) Analysis of the changes in the economic structure and development of the U.S. from colonial days to the present. Includes a survey of American economic life and the role of entrepreneurship in economic development. *F even years; preq. ECON 101 and 102*

ECON 332 Managerial Economics (4) Cross-listed as MGNT 332. Use of economic theory and decision making techniques in business management. Production and consumer theory, applied price theory, pricing of final products, theory of profits, profit management, capital budgeting, cost and demand analysis theory to provide a solid foundation of economic understanding for use in managerial decision making. *Not regularly offered; preq. ECON 101, 102, and MATH 201.*

ECON 405 Economic Development (4) Analysis of economic problems and prospects for development in general and of less developed nations in particular. *Preq. ECON 101 and 102*

ECON 411 Comparative Economic Systems (4) An analysis of the different economic systems: capitalism, socialism, communism, and mixed systems. Survey of the differences and similarities of the economic institutions among these systems. *Sp odd years; preq. ECON 101 and 102*

ECON 450 International Trade (4) Theoretical framework of international trade; problems and policies for free trade; roles of international institutions. *Sp even years; preq. ECON 101 and 102*

ECON 499 Special Topics in Economics (1-4) Individual or small-group study, under the supervision of instructor, of topics not otherwise available to students. Repeatable for credit. *Preq. ECON 101 and 102*

EDUC 110 The Teacher as an Inquiring Professional 1: Strategies for Observation and Reflection (2) An introduction to an explicit concept of teaching. The cycle of plan/act/observe/reflect is developed. An introduction to norms, conventions, expectations, and rewards for teachers. The distinctive nature, scope, sequence, and demands of Shawnee State University's program are outlined. *F W Sp*

EDUC 210 The Teacher as an Inquiring Professional 2: Strategies for Action Research (2) Continuation of the plan/act/observe/reflect cycle. Basic elements of action research are introduced by having students validate observations and data collection with one another in inquiry teams. *F W Sp; preq. EDUC 110*

EDUC 220 Social/Physical/Intellectual Growth and Development (3) Designed to bring prospective teachers face-to-face with their own development. It explores patterns of behavior, both verbal and nonverbal, which developed within the student's families-of-origin. Also explored are personality types, cognitive development, and life span development, all with thought regarding how these affect the teaching process. *F W Sp; preq. EDUC 110*

EDUC 230 Instructional Media, Technology, and Computers (2) A study of how media can be used both instructionally and to observe and reflect on practice. Operation of media, production of instructional aids, and selection of media appropriate to particular instructional strategies and objectives. *F W Sp; preq. EDUC 110*

EDUC 240 Foundations and Competing Epistemologies 1 (2) Examines the history of education in the U.S. as well as contemporary views of the relationship between school and society. *F W Sp; preq. EDUC 110*

EDUC 295 Independent Study (1-4) Exploration of special topics not included in the standard curriculum. *F W Sp*

EDUC 310 The Teacher as an Inquiring Professional 3: Measurement, Diagnosis, and Evaluation (3) Examines a wide range of diagnostic, formative, and summative evaluation techniques to be used as an integral part of the teaching/learning process. The emphasis is on selection and utilization of appropriate evaluation for individual learners. *F W Sp; preq. admission to teacher education program*

EDUC 320 Interdisciplinary Teaching Methods 1: Literacy and Social Studies (7) Incorporation of the general knowledge base for teaching. Problem solving and inquiry are emphasized in literacy and social studies. Content-specific and general methods, patterns of instruction, and diagnostic techniques are used in a laboratory context and practiced in field experiences. Inquiry and reflective activities focus planning and action on the moral and ethical intentions and consequences of classroom thinking, actions, and conditions. *F W Sp; req. admission to teacher education program; to be taken concurrently with EDUC 420*

EDUC 321 Advanced Developmental Reading (4) Designed to provide preservice teachers with the foundational knowledge of reading process, emergent literacy, and the principles underlying effective, holistic literacy instruction. *Req. EDUC 320*

EDUC 322 Teaching of Writing for Elementary Educators (4) This process-oriented course is designed to provide preservice and/or inservice teachers with in-depth treatment of the theoretical and practical knowledge base on the teaching of writing to children in elementary school settings. Grounded in current child development and literacy theories, this course builds on the foundational principles of literacy acquisition established in EDUC 320. *Req. EDUC 320.*

EDUC 323 Literature for Young Adults (4) A survey and methods course designed to give secondary and middle-school level preservice teachers experience in the range, quality, genres, and styles of literature suitable for use in classrooms. The course also offers experience in curriculum design, instructional deliveries, evaluation, and recordkeeping, as well as field-based practice with students in grades seven through twelve. *Req. admission to teacher education program*

EDUC 325 Instructing Adults (3) Cross-listed as AHNH 325. Study of adult learning needs and participation patterns. Teaching styles and techniques best suited to adults are analyzed and demonstrated.

EDUC 327 Methods of Teaching in Health and Occupations (3) Cross-listed as AHNH 327. The subject matter and teaching methodologies of health instruction in classrooms, laboratories, and community settings are analyzed and demonstrated.

EDUC 340 Foundations and Competing Epistemologies 2 (2) Examines the ethical dimensions of teaching. Foundational knowledge regarding ethics is used to discuss moral issues which commonly occur in schools. Methods of teaching moral education in the classroom are also explored. *F W Sp; req. EDUC 240 and admission to teacher education program*

EDUC 402 Community Health Education (3) Cross-listed as AHNH 402. Philosophy of community health education with emphasis on historical, conceptual, and legal precepts.

EDUC 420 Interdisciplinary Teaching Methods 2: Science and Mathematics (7) Incorporation of the general knowledge base for teaching. Problem solving and inquiry are emphasized in science and mathematics. Content-specific and general methods, patterns of instruction, and diagnostic techniques are used in a laboratory context and practiced in field experiences. Inquiry and reflective activities focus planning and action on the moral and ethical intentions and consequences of classroom thinking and actions. *F W Sp; req. admission to teacher education program and MATH 110S, 120, and 121; to be taken concurrently with EDUC 320*

EDUC 450 Directed Teaching and Seminar (15) A cumulative experience of ten weeks in area schools which includes a weekly seminar, both topical and process-oriented. *F W Sp; req. admission to the teacher education program and admission to student teaching*

EDUC 451 Internship in Health Management/Education (1-6) Cross-listed as AHNH 451. Health care management/education experience is obtained in selected institutions or agencies related to the student's health management/education interest and ability. Written reports are required. *Req. approval from the College of Health Sciences dean*

EDUC 461 Research Problems in Health and Recreational Education (3) Cross-listed as AHNR 461. Exploration of research methodologies, issues, and problems peculiar to health professions.

EDUC 495 Special Topics (2-4) Cross-listed as AHNR 495. Provides students an opportunity to gain additional knowledge or experience in a specific area or field.

EMTP 101 First Aid and CPR (2) Cross-listed as HPER 101. Includes the American Red Cross Standard First Aid Course related to bleeding control, obstructed airway management, splinting and bandaging techniques, and other emergency care procedures. Also includes the American Red Cross Adult CPR course. American Red Cross Standard First Aid certification and Red Cross Adult CPR certification are granted upon successful completion of course.

EMTP 102 CPR (1) Cross-listed as HPER 102. Techniques of cardiopulmonary resuscitation. American Red Cross or American Heart Association CPR certification is granted upon successful completion of this course.

EMTP 110 Emergency Victim Care (10) The Ohio Basic Emergency Medical Technician training course which provides the framework upon which all other skills and knowledge are developed. Principles of emergency care, CPR, vital signs, and patient handling techniques are included.

EMTP 120 EMS Systems (3) Introduction to pre-hospital emergency medical systems, including EMS history, types of systems, medical control, dispatch, quality assurance, communications systems, and record keeping.

EMTP 130 Major Incident Response (2) Provides the student with the theoretical and practical foundations necessary to manage multiple casualty situations in the pre-hospital environment.

EMTP 210 Paramedic Skills 1 (5) Expansion of basic skills and knowledge gained in the Basic EMTA course in the areas of shock and fluid therapy, anatomy and physiology, patient assessment, and respiratory emergencies. Advanced skills include IV therapy, esophageal intubation, and MAST. Includes DOT Paramedic Program Division 1 (Prehospital Environment, Sections 1-4) and Division 2 (Preparatory, Sections 1-5) and the administration of subcutaneous epinephrine for allergic reactions to insect stings.

EMTP 211 Paramedic Skills 1 Lab (1) Laboratory and clinical experience which correlate with Paramedic Skills 1.

EMTP 212 Paramedic Skills 1 Clinical (1) Hospital and field clinical experiences for EMTP 210.

EMTP 215 Advanced EMT Defibrillation (4) Prehospital diagnosis and treatment of various forms of sudden cardiac death. Focuses on prehospital defibrillation. Includes cardiovascular anatomy and electrophysiology, cardiopulmonary resuscitation, assessment and management of cardiac arrest, including electrical defibrillation. Successful completion allows the Ohio certified Advanced EMT to perform defibrillation. *Req. Ohio certified Advanced EMT-A; six months A-EMTA experience*

EMTP 220 Paramedic Skills 2 (3) Emphasizes gaining access to, rescuing, and transporting a patient. Recognition and control of certain hazards, such as explosive material, downed electrical wires, toxic gases, and radiation. Use of radio equipment, protocols, and procedures for the transfer of information to the supervising physician. Includes DOT Paramedic Program Division 1 (Prehospital Environment, Sections 5-6).

EMTP 230 Paramedic Skills 3 (8) Intensive emergency coronary care emphasis. Topics include pathophysiology, symptomatology, and emergency treatment of coronary artery disease, MI, angina pectoris, congestive heart failure, and other cardiac emergencies. Introduction to the general groups of drugs and the classification of each. Therapeutic effects, indications, contraindications, correct dosage, and side effects of specific drugs used in cardiac emergencies. Includes DOT Paramedic Program Division 2 (Preparatory, Section 5), Division 4 (Medical, Sections 1 and 2), and the American Heart Association Advanced Cardiac Life Support Provider course.

EMTP 231 Paramedic Skills 3 Lab (1) Laboratory and clinical experiences which correlate with Paramedic Skills 3.

EMTP 232 Paramedic Skills 3 Clinical (1) Hospital and field clinical experiences for EMTP 230.

EMTP 240 Paramedic Skills 4 (8) Builds advanced skills and knowledge in the areas of medical emergencies, trauma emergencies, obstetric/gynecologic emergencies, pediatrics, and neonatal transport. Emphasis placed on clinical and on-squad experience. Includes DOT Paramedic Program Division 3 (Trauma), Division 4 (Medical, Sections 3-11), Division 5 (OB/Gyn/Neonatal), and Division 6 (Behavioral).

EMTP 241 Paramedic Skills 4 Lab (1) Laboratory and clinical experiences which correlate with Paramedic Skills 4.

EMTP 242 Paramedic Skills 4 Clinical (1) Hospital and field clinical experiences for EMTP 240.

EMTP 250 Advanced Emergency Procedures (3) Didactic and laboratory instruction in advanced emergency procedures, such as nasotracheal intubation, cricothyrotomy, intraosseous infusion, external cardiac pacing, and other procedures.

EMTP 260 EMS Field Studies (3) Course relates field clinical experience of student to theory. Utilizes case review, discussion, and lecture for integration of theory with practice.

EMTP 270 EMS Management (3) Course develops knowledge and skills relative to management of an emergency medical service.

EMTP 295 Special Topics in EMS (1-4) Individual or small group study, under the supervision of an instructor, of topics not otherwise available to students.

ENGLISH PREREQUISITES: The communication sequence in the General Education Core is prerequisite for advanced courses in English/Humanities.

ENGL 095 Basic Writing 1: Mechanics (4) Provides intensive practice with the basics of written expression: grammar, punctuation, usage, spelling, and sentence structure. Emphasis on correct use of standard English. Also focuses on basic summary and paragraph writing. *Su F W Sp*

ENGL 097 Reading Development 1 (4) Initial reading course in developmental education. Major focus is on comprehension and vocabulary improvement, adaptability of reading rate, and test-taking skills. Includes recognition of patterns of organization, text structure/written discourse, metacomprehension, modes of thinking/writing, and aids to reading textbooks; strategies for building vocabulary, test taking, and controlling test anxiety. Recreational and journal reading are required. *Su F W Sp*

ENGL 098 Reading Development 2 (4) Second level reading course in developmental education. Major focus is on increased comprehension and vocabulary growth in content area reading. Includes identification and use of three levels of comprehension; recognition of cohesive ties; use of three-stage reading plans, ReQuest, PReP, reciprocal teaching, and questioning techniques; reading visual material; mapping, summarizing, and outlining textbook material; becoming metacomprehensive readers; building specialized vocabulary in the content areas; learning strategies for word association and grouping; test-taking skills; and controlling test anxiety. Reading fiction and non-fiction is required. *Su F W Sp*

ENGL 099 Basic Writing 2: Paragraphs and Essays (4) Provides practice in the process of writing and revising paragraphs and short essays. Standard organizational patterns for paragraphs and essays are required with an emphasis on the correct use of standard English. *Su F W Sp*

ENGL 105 Information Access (1) Prepares the student to find information using the Library's print and electronic indexes and bibliographies. The student formats a bibliography using a topic of his or her choice. *F W Sp*

SPECIAL NOTE: The university placement/assessment test is prerequisite to enrolling in ENGL 111S. Students completing developmental courses are required to pass not only the course itself; but also the course exit exam before enrolling in English 111S. ENGL 111S, 112S, and 115S **must** be taken in sequence, beginning with 111S. **This composition sequence is a prerequisite for advanced coursework in English (including the civilization and literature series).**

ENGL 111S Discourse and Composition¹ (4) An introduction to discourse in both public and academic settings. *Su F W Sp; req. placement or the appropriate developmental course(s), which may include ENGL 095, 097, 098, 099, and 100*

ENGL 112S Composition and Research¹ (4) An introduction to the relationship between research and composition. *Su F W Sp; req. ENGL 111S*

ENGL 115S Composition and Literature (4) An introduction to the genres of literary discourse and critical analysis. *Su F W Sp; req. ENGL 112S*

ENGL 120 Vocabulary Expansion (2) A non-developmental course intended primarily to enhance the vocabulary skills of students with a reasonable range of existing vocabulary. *F Sp*

ENGL 121 Technical Writing (3) A course which stresses clarity in technical communications with emphasis on the improvement of writing style and the mastery of exact organization. Types of writing include reports (formal and informal), proposals, resumes, and specifications. Because of the textbook and specific writing assignments, this course is not open to liberal arts students. *Su F W Sp; req. sophomore standing in a technical program*

ENGL 199 Topics in Literature (1-4) Study of selected topics not otherwise available. *Offered on demand*

ENGL 200 Introduction to Literature (4) An analysis of selected literary works which aims to develop reading and interpretive skills and to familiarize students with the language of literary study. *F*

ENGL 203 Introduction to Drama (4) Modern dramatic forms are analyzed in an attempt to define the genre. *Offered on demand*

ENGL 210 Introduction to Fiction (4) A study of forms and techniques of the novel, novella, and short story. *Offered on demand*

ENGL 211 Survey of English Literature 1 (4) Survey of the development of English literary traditions from the Medieval Period through the eighteenth century. *F*

ENGL 212 Survey of English Literature 2 (4) Survey of the development of English literature beginning with the Romantics and moving into contemporary writers and works. *W*

ENGL 222 Business Writing (4) A study of writing skills essential to the business world with special emphasis on the practical application of those skills to "real world" writing tasks. *Offered on demand*

ENGL 225S Civilization and Literature 1 (4) Cross-listed as HIST 225S. General education core requirement. Part of a three-course sequence designed to introduce students to western, American, and non-western cultures. This course is an interdisciplinary introduction to the major thoughts important in the development of western civilization. *Su F W Sp*

ENGL 226S Civilization and Literature 2 (4) Cross-listed as HIST 226S. General education core requirement. An interdisciplinary introduction to the major thoughts important in the development of American civilization. *Su F W Sp*

¹ In keeping with the General Education Core program's commitment to computer literacy (see *Catalog* p. 47), several sections of this course use computers in the teaching of composition.

- ENGL 227S Civilization and Literature 3 (4)** Cross-listed as HIST 227S. General education core requirement. An interdisciplinary introduction to the major thoughts of various non-western civilizations. *Su F W Sp*
- ENGL 232 Creative Writing (Poetry) (3)** A poetry writing course in which conventional, blank, and free verse, as well as techniques of poetic expression are taught. *F Sp*
- ENGL 240 Screenwriting (3)** An introduction to the elements of screenwriting. Students develop a screen adaptation of a published fictional work as well as study important distinctions between visual and linguistic art forms. *Offered on demand*
- ENGL 245 Creative Writing (Fiction) (3)** An introduction to the elements of fiction writing. Students critique their own manuscripts as well as study selected works of published writers. *Sp*
- ENGL 249 Native American Literature (4)** Study of works written by Native American writers.
- ENGL 251 Survey of American Literature 1 (4)** Study of major works and major authors from the Colonial Period through American Romanticism. *F*
- ENGL 252 Survey of American Literature 2 (4)** Study of major works and major authors from the Age of Realism to the twentieth century. *Sp*
- ENGL 273 Modern American Poetry (4)** Study of themes and forms prevalent in modern American poetry. *Offered on demand*
- ENGL 275 American Film History (4)** Chronological study of the influence of American history upon American film, and vice versa. Students will become acquainted with the work and themes of some of America's significant film directors and major genres of American popular film.
- ENGL 280 Introduction to American Studies 1 (4)** Interdisciplinary study of American culture. *Offered on demand*
- ENGL 281 Introduction to American Studies 2 (4)** Interdisciplinary study of American culture. *Offered on demand*
- ENGL 299 Topics in English (1-4)** Study of selected topics not otherwise available. *Offered on demand*
- ENGL 300 Children's Literature (4)** Readings in literature that appeals specifically to elementary students. *Sp*
- ENGL 301 Shakespeare 1 (4)** Intensive study of the tragedies and histories. *F*
- ENGL 302 Shakespeare 2 (4)** Intensive study of the comedies and problem plays. *Sp*
- ENGL 311 Major English Authors (Before 1800) (4)** A variable content course which focuses on major authors for the purpose of carefully analyzing their works and detailing their development as writers. *F Sp*
- ENGL 312 Major English Authors (After 1800) (4)** A variable content course which focuses on major authors for the purpose of carefully analyzing their works and detailing their development as writers. *Offered on demand*
- ENGL 315 Theory and Practice in Composition (4)** Study of varied methods and strategies for teaching composition with special attention to classroom application for teachers. *W*
- ENGL 321 The English Novel (4)** A variable content course which examines the emergence and development of the English novel. *Offered on demand*
- ENGL 322 Modern English Drama (4)** Study of the developments in English theatre in the 20th century. *Offered on demand*

- ENGL 332 Poetry Workshop (3)** An advanced poetry writing course with a major emphasis placed on critiquing the writing of the students in the class for the sake of successfully marketing their work. *W*
- ENGL 341 Literature of Initiation and Experience (4)** Study of literary works which detail growth and development of character. *Offered on demand.*
- ENGL 342 Women in Literature (4)** Study of works by and about women. *W*
- ENGL 343 Black Authors (4)** Study of works about the Black experience. *Offered on demand*
- ENGL 344 Literature of Appalachia (4)** Exploration of southern Appalachian experience in literature. Includes works by authors past and present who are themselves products of the region or who have focused on the region in their prose or poetry. *Sp*
- ENGL 346 River Literature (4)** Study of literary works in which rivers are central factors influencing experience. *Offered on demand*
- ENGL 349 Regional American Literature (4)** A variable content course of literary works which are distinct to a region and which provide a social perspective unique to a particular time and place. *Offered on demand*
- ENGL 351 Major American Authors (4)** Intensive study of one or two major authors to provide a detailed understanding of works, thought, and literary development. *Sp*
- ENGL 360 Introduction to Language and Linguistics (4)** Cross-listed as LING 270. An introduction to the fundamental properties and processes of the world's languages. A review of the major systems and features which constitute language. A discussion of language change, typology, and aspects of language acquisition. *F Sp*
- ENGL 362 Patterns of English (4)** Cross-listed as LING 362. A survey of various components of English phrase, clause, and sentence structure and an examination of questions of usage. *W Sp; suggested preq. ENGL 360*
- ENGL 365 History of English (4)** Cross-listed as LING 365. A survey of the patterns and events which have shaped the English language from the time of the Anglo-Saxon to the present. *W; suggested preq. ENGL 360*
- ENGL 371 The American Novel (4)** A variable content course which examines the emergence and development of the American novel. *Offered on demand*
- ENGL 380 Fundamentals of Rhetoric (4)** Study of both ancient and modern theories of rhetoric. *Offered on demand.*
- ENGL 381 Fundamentals of Criticism (4)** Study of both ancient and modern theories of criticism. *Offered on demand*
- ENGL 383 The English Teacher and Society (4)** Analysis of the role of the English teacher in modern society, of the philosophies which underlie various methods of English teaching, and of the rationales for choosing various texts and methods. *W*
- ENGL 411 16th Century Renaissance Literature (4)** Study of the major works of selected authors such as More, Sidney, Spenser, Marlowe, Shakespeare, Shelton, Wyatt, Surrey, and others. *Sp*
- ENGL 421 17th Century Poetry and Prose (4)** Study of the major works of selected authors such as Bacon, Carew, Cowley, Donne, Herrick, Jonson, Marvell, Webster, and Milton. *W*
- ENGL 441 The Romantics (4)** Study of the poetry and prose of major Romantic writers, including Blake, Wordsworth, Coleridge, Shelly, Byron, and Keats. *Offered on demand*
- ENGL 446 The Victorians (4)** Study of English poetry and prose from 1830 to 1900. *Offered on demand*

ENGL 449 Native American Literature (4) Study of works written by Native American writers.

ENGL 460 Topics in Linguistics (4) Senior seminar in selected topics in linguistics: linguistics and literature, social aspects of language, psychological aspects of language, varieties of English, English as a second language, and Black English (including Pidgin and Creole). Can be taken more than once when different themes are offered. *Offered on demand; preq. ENGL 360 and 365*

ENGL 461 19th Century American Literature (4) Intensive study of major authors and works of the 19th century. *F*

ENGL 471 20th Century American Literature (4) Intensive study of major authors and works of the 20th Century. *W*

ENGL 485S Community Involvement (Core Course) (2) Community Involvement is an outgrowth of the purposes and objectives of the University. The series of activities integral to the Community Involvement course enhance the education of the student, complement the senior seminar, and promote reflection on the student's obligation to human beings in need and society at large. *(not offered summer quarter)*

ENGL 490S Senior Seminar (Core Course) (4) Provides an opportunity for students to place their chosen field of study in an interdisciplinary context with intellectual, ethical, and historical perspectives. The seminar focuses on the synthesis and integration of various concepts by applying them to the analysis and solution of problems chosen in the context of their academic disciplines. Oral and written presentations of the seminar paper are required. *Su F W Sp; preq. senior standing and 44 core hours*

ENGL 495 Independent Study (4) Independent investigation of literary topics under the direction of a faculty member. *Offered on demand*

ENGL 499 Topics in Literature (1-4) A seminar course in selected topics in literature. Specific topic chosen by the instructor. *W Sp*

ESL 91 Elementary English 1 (4) Development of elementary listening, comprehension, speaking, reading, and writing skills in English. Laboratory exercises are used to reinforce these skills. *Offered on demand*

ESL 92 Elementary English 2 (4) Continuation of ESL 91. *Offered on demand; preq. ESL 91*

ESL 93 Elementary English 3 (4) Continuation of ESL 92. *Offered on demand; preq. ESL 92*

ESL 94 Intermediate English 1 (4) Development of intermediate oral communication skills in English, but with increased emphasis in reading and writing. May be taken concurrently with ESL 93. *Offered on demand; preq. ESL 93 or satisfactory score on ESL assessment test*

ESL 95 Intermediate English 2 (4) Continuation of ESL 94. *Offered on demand; preq. ESL 94 or satisfactory score on ESL assessment test*

ESL 96 Intermediate English 3 (4) Development of advanced communicative skills in English. May be taken concurrently with ESL 97, 98, and 99. *Offered on demand; preq. ESL 95 or satisfactory score on ESL assessment test*

ESL 97 Advanced English 1 (4) A follow-up to ESL 96. A course emphasizing oral proficiency and applied grammatical concepts. Improvement of speed and comprehension in reading through conscious analysis of paragraph structure and recognizing the progressive development of ideas. May be taken concurrently with ESL 96, 98, and 99. *Offered on demand; preq. ESL 96 or satisfactory score on ESL assessment test*

ESL 98 Advanced English 2 (4) Training in the fundamental skills, including grammar, usage, organization, and development. For international students, includes idiomatic expressions and problems common to non-native speakers of English. Utilizes methodologies appropriate for international students. Designed to prepare international students for Discourse and Composition. *Offered on demand; preq. ESL 96 or satisfactory score on ESL assessment test*

ESL 101 English for International Students (Equivalent to ENGL 111S) (4) Review of sentence structure, mechanics and usage, paragraph development, and short essay organization. For international students, includes reading and analysis of prose models and work on other English fundamentals. Emphasis on revising for clarity, coherence, and organization. Utilizes methods appropriate for ESL students. *Offered on demand*

ETCA 101 Introduction to CADD (3) Hands on experience using industrial standard hardware and software for computer aided drafting. Students learn to set up, edit, and output drawings using the latest in CADD technology. Introduction to file management techniques and the disk operating system (DOS). All classes focus on the use of AutoCAD[®] unless otherwise stated. *F W Sp; coreq. ETEG 101 or advisor approval; 2 lec. 3 lab*

ETCA 102 Mechanical Drafting with CADD (3) Students further develop and refine skills in operating a CADD workstation. Additional commands and more advanced techniques are introduced involving typical 2-D mechanical drafting and design techniques. *W; preq. ETCA 101 or advisor approval; 2 lec. 3 lab*

ETCA 103 CADD Menu Customization (3) Students develop symbol libraries and icons to be used with student developed tablet and screen menus. *W; preq. ETCA 101 or advisor approval; 2 lec. 3 lab*

ETCA 104 Advanced Drafting with CADD (3) Advanced drafting and CADD concepts to include surface design and development and advanced descriptive geometry techniques. *Sp; preq. ETCA 102 or advisor approval; 2 lec. 3 lab*

ETCA 105 3-D Modeling with CADD (3) Wireframe modeling, surface modeling, and solid modeling are taught with an emphasis on mechanical parts design. Students gain an appreciation for the capabilities and limitations of each modeling technique. *Sp; preq. ETCA 101 or advisor approval; 2 lec. 3 lab*

ETCA 120 Introduction to CADKEY[®] (3) Introduction to 3-D modeling concepts using alternate CADD package(s) to help the student progress into the design of plastics mold cavities. *Sp; preq. or coreq. ETEG 101; 2 lec. 3 lab*

ETCA 150 Computer Aided Machining (3) Introduction to Computer Aided Machining (CAM), intended for students having no prior CAM experience. The course focuses on the creation and editing of tool path geometry, display control, file manipulation, verification of data, output of hardcopy, and generation of CNC code. *Preq. ETCA 101 or advisor approval*

ETCA 201 Small Building Design with CADD (3) Introduction to architectural drafting through the design of a residential structure. Students create the drawings necessary to complete a typical set of house plans. Topics include, but are not limited to, design techniques, floor plans, foundation plans, elevations, wall sections, window and door schedules. *Sp; preq. ETCA 103; 2 lec. 3 lab*

ETCA 202 Piping Drawings with CADD (3) Representation of piping in single and double line diagrams, isometric and orthographic diagrams. Design of pipe flanges given the size of pipe and the operating pressure. Template layouts for cutting pipe to form turns of various angles. *F; preq. ETCA 103; 2 lec. 3 lab*

ETCA 203 Welded Parts Design with CADD (3) Welding processes and procedures are covered to the extent necessary to make production weldment drawings. Delineating weld symbols is emphasized. *W; preq. ETCA 103; 2 lec. 3 lab*

ETCA 204 Casting and Mold Design with CADD (3) Completion of a set of plans giving the specifications a foundry would need to manufacture a part. The plans include: a pattern drawing with gates, a core box drawing, the casting drawing of the part, and machined part drawing. *Sp; preq. ETCA 103; 2 lec. 3 lab*

ETCA 205 LISP Programming (3) A wide range of design problems are solved using LISP programming, subsequent to a thorough study of LISP functions, variable naming conventions, entity access, and device access. A variety of existing LISP routines and student written routines are analyzed. *F; preq. ETCA 103 or advisor approval; 2 lec. 3 lab*

ETCA 220 Intergraph MicroStation (3) An introductory course on the methods and techniques of using Intergraph MicroStation. Students develop skills in both 2-D drafting and 3-D design. *W; Preq. ETCA 101 or advisor approval*

ETCA 230 Rendering and Animation (3) Advanced techniques in rendering and animating 3-D CAD models for presentation graphics. Animated "fly-bys" and "walk-throughs" allow the operator to view the CAD model as though walking through it or flying past it. Rendering techniques include the use of AutoDesk's 3-D Studio. *Preq. ETCA 105 or advisor approval*

ETCA 250 Solid Modeling (3) In-depth instruction in solid modeling using constructive solid geometry and Boolean operations. Students create solid models and calculate mass properties to solve mechanical design problems. *Sp; preq. ETCA 105*

ETCA 299 Special Topics in CADD (1-5) Offered as an elective for CADD students. Covers topics of special interest. *Preq. instructor permission*

ETCO 110 Computer Software and DOS (2) Computer hardware and software concepts and fundamentals, including operating systems (DOS), the use of windows and integrated applications software for word processing, spreadsheeting, and data bases. *F W Sp*

ETCO 115 Computer Programming for Technology (3) Utilization of computer hardware, a high level programming language, algorithms, and flowcharting to develop modular and structured programs for engineering technology applications. The emphasis of the laboratory work is to develop, debug, execute, and document BASIC language programs. Some knowledge of algebra is necessary. *F W Sp; coreq. ETCO 110; 2 lec. 3 lab*

ETCO 202 Statics and Strength of Materials (4) A study of the principles of torque and displacement in a wide variety of gearing applications along with the analysis of forces or loads acting upon the system. Analysis of stress and strain, strength of materials, friction, torsion, and moment of inertia. *F; preq. PHYS 201 or advisor approval; 3 lec. 3 lab*

ETCO 210 Occupational Safety and Health Management (3) Industrial safety, occupational health issues, accident prevention, working conditions, provisions and policies of OSHA. Compliance with OSHA regulations. *F Sp; preq. sophomore standing and GPA of 2.0 or advisor approval*

ETCO 220 Hydraulics and Pneumatics (3) A study of the functions of various hydraulic and pneumatic components and methods of combining them to build complex systems. Emphasis on understanding the physical properties of fluids and gases and their use for power transmission and for control. *W Sp; preq. MATH 131, PHYS 201, or advisor approval; 2 lec. 3 lab*

ETCO 225 Industrial Management (3) Understanding the attributes and skills necessary to be an effective team builder, communicator, supervisor, or manager. Prepares the student for leadership positions in industrial and high technology organizations. *F W; preq. sophomore standing and GPA of 2.0 or advisor approval*

ETCO 230 Introduction to Robotics (3) Introduction to applications in industry. Emphasis on types, classifications, types of motion, economic impact, and safety. *Sp; 3 lec. 2 lab*

ETCO 485S Community Involvement (Core Course) (2) Community Involvement is an outgrowth of the purposes and objectives of the University. The series of activities integral to the Community Involvement course enhance the education of the student, complement the senior seminar, and promote reflection on the student's obligation to human beings in need and society at large. *(not offered summer quarter)*

ETCO 490S Senior Seminar (Core Course) (4) Provides an opportunity for students to place their chosen field of study in an interdisciplinary context with intellectual, ethical, and historical perspectives. The seminar focuses on the synthesis and integration of various concepts by applying them to the analysis and solution of problems chosen in the context of their academic disciplines. Oral and written presentations of the seminar paper are required. *Su F W Sp; preq. senior standing and 44 core hours*

ETEC 102 Structured Programming (3) An introduction to the software development process through a modern block-structured language such as Pascal. Computer problem solving and program debugging strategies, data abstraction, modularity, parameter passing, and elementary data structures. *W; preq. ETCO 110 and 115; 2 lec 3 lab*

ETEC 103 Data Structures (3) Fundamentals of computer data structures. Linked lists, stacks, and queues. Recursion and recursively-defined data structures. Tree structures. Advanced methods for searching and sorting, including hashing techniques. Introduction to complexity analysis. *Sp; preq. ETEC 102; coreq. MATH 220; 2 lec. 3 lab*

ETEC 210 Introduction to Electricity/Electronics (4) Fundamental principles of DC and AC electricity. An introduction to motors, generators, relays, and transformers. An introduction to electronics with emphasis on process control applications, including PLCs. Not for electromechanical or electrical/computer majors. *W; preq. MATH 130 or equivalent or advisor approval; 3 lec. 3 lab*

ETEC 211 Assembly Language Programming 1 (3) Machine representation of numeric and non-numeric data, basic CPU architecture, instruction sets, addressing methods, arithmetic operations with integer and floating point data, subroutines, and basic input and output techniques. *F; preq. ETEC 103; 2 lec. 3 lab*

ETEC 212 Assembly Language Programming 2 (3) Continuation of ETEC 211. Advanced input and output techniques, techniques for interrupt handling, subroutine linkage of separately assembled modules, and drivers for custom built interfaces. *W; preq. ETEC 211; 2 lec. 3 lab*

ETEC 241 Microprocessor Circuits 1 (3) The study of small microprocessor based systems. Simple busses, timing, memory systems, and decoding. Techniques for interfacing MSI, LSI, and VLSI chips to system busses. Lab emphasis on building a complete microprocessor based system. *W; preq. ETEC 211; coreq. ETEC 212 and ETEM 211; 2 lec. 3 lab*

ETEC 242 Microprocessor Circuits 2 (3) Continuation of ETEC 241. PLD, EPROM, and EEPROM uses and programming. Basic I/O techniques, signal conditioning and interfacing to the physical world. Lab emphasis on interfacing simple physical devices such as LEDs, switches, and motors to a microprocessor based system. *Sp; preq. ETEC 241 and ETEM 211; 2 lec. 3 lab*

ETEC 275 Systems Programming (3) A study of computer systems software and its role in modern computing systems. Operational and design details of assemblers, compilers, and linking loaders. Command language programming in modern operating systems. User interface design. Large systems programming project required. *Sp; preq. ETEC 212; 2 lec. 3 lab*

ETEC 280 Programming Languages (3) A survey of the major developments and evolution of procedural, functional, logic, object-oriented, and parallel programming languages. Representation of elementary and structured data types, expression evaluation, flow of control, parameter passing techniques, recursion, and run-time storage allocation. *W; preq. ETEC 211; coreq. ETEC 212; 2 lec. 3 lab*

ETEC 315 Computer Architecture 1 (4) Focus on advanced microprocessor architectures. Lecture topics include internal microprocessor architectures, advanced busses, system components, system interconnect and comparative microprocessor evaluation. Lab emphasis on building advanced microprocessor based systems. *W; preq. ETEC 242; 2 lec. 6 lab*

ETEC 316 Computer Architecture 2 (4) Continuation of ETEC 315. Microprocessor applications and advanced interfacing techniques. Interrupts, DMA, and programmable timers. Lab emphasis on using advanced microprocessor based systems to build applications that interact with the physical world. *Sp; preq. ETEC 315; 2 lec. 6 lab*

ETEC 350 Computer System Integration (4) Hardware and software integration techniques for stand alone and networked computer systems. Lecture covers motherboards, floppy drives, hard drives, video boards, network adaptor cards, cabling, and network system software. Lab emphasis on assembling and integrating a networked computer system. *F; preq. ETCO 110 and 115; 2 lec. 6 lab*

- EETEC 355 Management of Technology (3)** Study of the aspects of technology management including trends in technology, product and process risks, effective communication, understanding government regulation and socio-political involvement, effective resource management, international technology transfer, and ethics. *W; preq. junior standing or instructor approval*
- EETEC 361 Advanced Circuit Analysis (3)** Application of calculus to the modeling of systems. Mathematical approach to initial conditions. Introduction to (and application of) integral-differential equations to modeling of circuits and systems. Frequency domain analysis and Laplace transforms are introduced as an analysis tool. Application of PSPICE, BASIC, and/or 'C' computer programming to modeling of different systems. *F; preq. ETEM 112; coreq. MATH 202; 3 lec.*
- EETEC 362 Advanced Circuit Analysis 2 (4)** Application of Laplace transforms to system differential equations in the time and frequency domains with sinusoidal and complete harmonic signals. Topics include transfer functions, frequency response, and BODE plots, transients in DC/AC networks, initial conditions, mesh analysis, superposition, the Initial and Final Value Theorems and the Shifting Theorem. A laboratory component is directed at demonstrating the transient effects of both AC and DC stimulus. *W; preq. EETEC 361; 3 lec. 3 lab*
- EETEC 371 Operating Systems 1 (3)** An initial study of the concepts and structure of operating systems. Device management and interrupt processing. Sequential and concurrent processes. Virtual machines and memory management. Job and processor scheduling. *F; preq. EETEC 275; 2 lec. 3 lab*
- EETEC 372 Operating Systems 2 (3)** Continuation of EETEC 371. I/O systems and control. Multiprocessing organizations. Algorithms for distributed processing. Operating system security and protection. Current areas of research. *W; preq. EETEC 371; 2 lec. 3 lab*
- EETEC 373 Advanced Operating Systems (3)** A study of operating systems design principles. Particular attention is devoted to memory management, interprocess communication and synchronization, device drivers and device management, the file system, clock management, and the user interface. Actual source code for a fully-functional operating system is examined and modified. *Sp; preq. EETEC 372; 2 lec. 3 lab*
- EETEC 375 Networking and Communications 1 (3)** Interfaces from a computer system to external devices which support asynchronous and synchronous communications, flow-control paths, data transfer, packets, and physical interfaces. *F; preq. EETEC 242 and 275; 2 lec. 3 lab*
- EETEC 376 Networking and Communications 2 (3)** A study of the ISO model protocols, logical connections and services, streams and datagrams, internetworking and routing, and servers. *W; preq. EETEC 375; 2 lec. 3 lab*
- EETEC 408 Algorithms and Problem Solving (3)** A study of computer algorithms and their effective design, analysis, and realization. Solvable and unsolvable problems. Computationally easy versus computationally hard problems. Consideration of both scientific and creative problem solving strategies used to derive efficient algorithms. Application of abstract algorithms to problems which occur frequently in computing and the real world. Methods for analyzing and improving program performance. *F; preq. EETEC 212; 2 lec. 3 lab*
- EETEC 430 Database Systems (3)** A study of database management systems including the design, implementation, and maintenance of databases, applications, and programming techniques. Including the logical and physical representations of hierarchical, simple, and complex data and file relationships and their application in the major data models with a focus on the relational model. *F; preq. EETEC 371 or advisor approval; 2 lec. 3 lab*
- EETEC 460 Digital Control Systems (4)** A study of the methods used to implement control theory concepts on digital machines. Analog vs. digital machines, open and closed loop systems, block diagrams, PID control algorithms. Lab emphasis on controlling physical devices using computer based control algorithms. *F; preq. EETEC 316 and 362; 2 lec. 6 lab*

ETEC 477 Concurrency (3) Principles of concurrent programming. Synchronization and interference. Data parallel algorithms and barriers. The mutual exclusion problem. Semaphores, monitors, and conditional critical regions. Synchronous and asynchronous message passing. Remote procedure call and rendezvous. Exploration of popular process interaction paradigms. *Sp; preq. ETEC 372; 2 lec. 3 lab*

ETEC 480 Compiler Design and Implementation (3) Application of finite state automata as regular expressions to programming language design and analysis of the use of context-free grammars as a formal device for language syntax. Techniques of lexical analysis and parsing (top-down and bottom-up), symbol table management, code generation, and error handling. *W; preq. ETEC 275 and 280; 2 lec. 3 lab*

ETEC 483 Software Engineering (3) An introduction to models and issues concerned with the development of high quality software including the life-cycle models, requirements analysis, specification and design techniques, implementation, documentation, configuration management, reliability, verification and validation, and maintenance. *F; preq. ETEC 355 and ENGL 121; 2 lec. 3 lab*

ETEC 490 Senior Project 1 (4) Real-world detailed applied design project combining theoretical and experimental elements in advanced development of the primary area of student interest under the guidance of faculty mentor. Includes a thesis. *W; preq. senior standing; 1 lec. 9 lab*

ETEC 491 Design Laboratory 1 (4) A capstone experience in computer engineering technology involving the application of hardware and software components. The student demonstrates computer engineering technology competence by using the deductive method to apply computing concepts from the computer engineering program to an applications design project under the guidance of a faculty mentor. *W; preq. senior standing; 1 lec. 9 lab*

ETEC 492 Design Laboratory 2 (4) Continuation of ETEC 491. *Sp; preq. ETEC 491; 1 lec. 9 lab*

ETEC 495 Topics in Computing (3) A survey of contemporary developments in computer technology focusing on emerging hardware, software, and integrated systems. Discussions of new communications technology, architectures, processors, and applications guide the student in planning for future career decisions. *W; preq. senior standing or advisor approval; 2 lec. 3 lab*

ETEG 101 Engineering Drawing 1 (3) A basic course for students who have had little or no experience in engineering drawing. Develops fundamental principles through actual experience in both freehand sketching and scaled machine drawings. Includes orthographic, multiview drawings, geometric constructions, dimensioning practice, sectional views, and auxiliary views. *F W; 2 lec. 3 lab*

ETEG 102 Engineering Drawing 2 (3) Application of basic principles to solve practical engineering problems. Surface design and development and applied descriptive geometry are used to determine the relationship between points, lines, and surfaces in spaces. *W; preq. ETEG 101 or advisor approval; 2 lec. 3 lab*

ETEG 103 Engineering Drawing 3 (3) Advanced drafting course. Includes detail and assembly drawings, parts lists, thread details and specifications, gear details, classes of fit and tolerances, and geometric dimensioning and tolerancing. *Sp; preq. ETEG 102 or instructor approval; 2 lec. 3 lab*

ETEG 105 Blueprint Reading (2) Fundamentals in reading and interpreting engineering drawings, blueprints, and schematics (pneumatic, hydraulic, electrical, and electronic). Using drawings to understand specification sheets, installation details, and to develop bills-of-material. Recognizing and understanding standard drawing symbols and terminology. *W; 2 lec.*

ETEG 299 Special Topics in Engineering Drawing (1-5) Offered as an elective for engineering drawing students. Covers topics of special interest. *Preq. instructor permission*

ETEM 096 Electro Concepts (4) A course in the concepts of electricity and electronics. Introduction to concepts of Ohm's Law, resistance, capacitance, inductance, power, and energy. Study of reactance, impedance, phasors, and power factors. DC and AC rotating machines are surveyed. Elementary solid state electronics. This course is not for electromechanical or electrical/computer majors and is not applicable toward an associate degree.



- ETEM 111 Electrical Fundamentals 1 (DC) (4)** An introductory course in the study of electricity. Basic definitions of energy and electricity are introduced which lead to studies of resistance, Ohm's Law, series and parallel circuits, magnetism, simple meters, inductance, and capacitance. Direct current effects only. *F; coreq. MATH 130 or equivalent or advisor approval; 3 lec. 3 lab*
- ETEM 112 Electrical Fundamentals 2 (AC) (4)** Simple inductance-resistance and capacitance-resistance transient circuits; studies of alternating current fundamentals, phasor algebra, AC circuit analysis, power factor, and resonance. *W; preq. ETEM 111 or advisor approval; 3 lec. 3 lab*
- ETEM 115 Electromechanical Devices (3)** An introduction to devices where both electrical and mechanical principles are utilized. Includes DC motors and generators, 3-phase circuits, transformers, induction motors, alternators, and synchronous motors. *W; coreq. ETEM 112 or advisor approval; 2 lec. 3 lab*
- ETEM 121 Electronics 1 (3)** Introduction to discrete, bipolar solid state electronic devices and basic electronic circuits, including small signal amplifiers, transistor biasing, equivalent circuits, electronic unregulated DC power supplies, and special solid state devices. *Sp; preq. ETEM 112 or advisor approval; 2 lec. 4 lab*
- ETEM 122 Electronics 2 (3)** Continuation of ETEM 121. Frequency response; decibels; cascaded, feedback, power, and field effect amplifiers; unijunction transistors; control circuits; four-layer devices; op amps; and regulated DC power supplies. *F; preq. ETEM 121 or advisor approval; 2 lec. 3 lab*
- ETEM 130 Electromechanical Drawing (2)** The study of mechanical drawing of both electrical and electronic circuits and components using electrical and electronic symbols. Includes power distribution, logic diagrams, printed circuits, schematics, and pictorial views. *Sp; preq. ETEG 101 or advisor approval; coreq. ETEM 121; 1 lec. 3 lab*
- ETEM 201 Electromechanical Systems (3)** An introduction to systems which use both electrical and mechanical principles. Thermal, hydraulic, pneumatic, vacuum, magnetic, and optic systems are utilized to stress the coordinated combination of previously learned concepts. *F; coreq. ETEM 122 or advisor approval; 2 lec. 3 lab*
- ETEM 208 Automation Fundamentals (3)** A study of electromechanical open and closed loop analog and digital systems. The microcomputer and programmable logic controller are used to interface a variety of input and output transducers to build complete automatic control systems. Emphasis on understanding interfacing feedback signals to process control. *W; preq. ETEM 115, 122, and 201; coreq. ETCO 220 and ETEM 211; 2 lec. 3 lab*
- ETEM 209 Robotics (3)** A survey course in Robotics which studies types of industrial robots, control schemes, and applications. *W; coreq. ETEM 208, ETEM 211, ETCO 220, or advisor approval; 2 lec. 3 lab*
- ETEM 211 Electronic Logic Circuits 1 (4)** An introduction to solid state, integrated electronic logic. Practical applications of Boolean algebra, logic gates, binary pulse circuits, number systems, and computer arithmetic. *W; preq. ETEM 121 or advisor approval; 3 lec. 3 lab*
- ETEM 212 Electronic Logic Circuits 2 (4)** Continuation of ETEM 211. Integrated circuit applications which include combinational and sequential logic, printed circuits, counters, registers, decoders, signal converters, and an introduction to microcomputers. *Sp; preq. ETEM 211 or advisor approval; 3 lec. 3 lab*
- ETEM 215 Electromechanical Design (3)** Designed to provide the time and opportunity for students to work on the design, fabrication, assembly, and testing of electromechanical devices or systems. Promotes independent study, initiative, and creativity by requiring the student to develop the design with minimal staff supervision. *Sp; preq. ETEM 201 and 211; coreq. ETEM 212; 1 lec. 6 lab*
- ETEM 220 Technical Presentations (2)** Encompasses all of the principles which have been considered previously in the program. Electromechanical systems are analyzed and presented by the student. A thorough understanding of the applied principles is required. *Sp; preq. ETEM 115, 122, 201, 208, and 211, ETCO 220, or advisor approval; 1 lec. 3 lab*

ETIN 103 Industrial Electricity (3) Designed to familiarize the student with the National Electrical Code and practices used in industry to install electrical conductors, switching equipment, and overload protection and equipment. Course study includes motors, generators, and machine controls. *Sp; preq. ETEM 111 and 112; 2 lec. 3 lab*

ETIN 111 Industrial Electronics (3) Designed to familiarize the student with industrial electronic circuits, including amplifiers, DC power supplies, and integrated circuits. *Sp; preq. ETEM 111 and 112; 2 lec. 3 lab*

ETIN 120 Process Instrumentation (4) Introduction to measurement and control systems for temperature, pressure, and fluid flow. Dynamic response characteristics of instruments and calibration methods. Introduction to transducers, transmitters, controllers, and control systems. Both electrical and pneumatic systems are included. *Sp; 3 lec. 3 lab*

ETIN 185 Instrumentation Internship (6) Eleven weeks of supervised work experience in industry which relates directly to the student's field of study. Supervisory visits by the instructor are coordinated with periodic evaluations by the industry to critique the performance of the student. *40 lab*

ETIN 201 Instrumentation Electronics (4) Designed to familiarize the student with the electronic equipment and devices found in electronic instrumentation. High voltage power supplies, amplifiers, input and output transducers, recording devices, ultrasonics, synchros, telemetering, remote control, and optical electronics are included. *F; preq. ETIN 111; 2 lec. 5 lab*

ETIN 202 Programmable Controllers 1 (4) Introduction to basic industrial control circuits and schemes using the programmable controller as a control device. Instruction on the proper methods of programming the controller for the desired scheme. *F; preq. ETIN 111; 2 lec. 5 lab*

ETIN 203 Programmable Controllers 2 (4) A continuation of ETIN 202, including more advanced control using the controller as a programmable controller. Proper methods of interfacing the programmable controller to the controlled device and peripheral devices. *W; preq. ETIN 111 and advisor approval; 2 lec. 5 lab*

ETIN 221 Instrument Fundamentals (4) Designed to provide the student with a knowledge of instruments. Introduction to the field, ship and industrial safety, care and use of hand and power tools, soldering techniques, reading and interpreting instrumentation drawings, measurement and control devices, final control elements, and standards and calibration. *F; preq. ETIN 120; 3 lec. 3 lab*

ETIN 223 Measurement Principles (4) Industrial methods of measuring pressure, temperature, and flow with various types of measuring devices. The theory of operation of manometers, thermometers, strain gauges, and other precision measuring equipment. *Sp; preq. ETIN 201 and 221; 3 lec. 3 lab*

ETIN 224 Industrial Control (4) Introduction to basic industrial control circuits and schemes. Pneumatic, hydraulic, electrical, and electronic control. *W; 3 lec. 3 lab*

ETIN 225 Distributive Control Systems (4) The procedures of using and configuring a distributive process control system. The student is required to implement the control system. *Sp; preq. ETIN 224; 3 lec. 3 lab*

ETIN 251 Biomedical Instrumentation (4) Study of cardiovascular instruments; pacemakers; defibrillators; and respiratory, ultrasound, and other life-supporting and life-saving instruments. *3 lec. 2 lab*

ETIN 252 Techniques and Devices for Electronic Troubleshooting (4) Instructs the student in procedures for finding malfunctioning cards and components in electronic instruments. Test equipment is used to find the malfunctioning components. *Preq. ETIN 210 and 251; 3 lec. 2 lab*

ETIN 253 Internship 1 Work in Hospital (3) Students work in a hospital with biomedical personnel, under the direct supervision of the hospital. *Preq. ETIN 252; coreq. ETIN 251; 1 lec. 14 lab*

- ETIN 261 Instrumentation for Circulatory Systems (3)** Study of instruments used in the circulatory system—acoustic, ultrasonic, electronic, and radiologic devices. *Preq.* ETIN 252; 2 lec. 2 lab
- ETIN 262 Bio Voltages (3)** Study of the origin and usefulness of ECG, ERG, and EEG. *Preq.* ETIN 251; 2 lec. 2 lab
- ETIN 263 Internship 2 Work in Hospital (3)** Continuation of ETIN 253. Safety testing, preventive maintenance, inspection, troubleshooting, and repair of biomedical equipment under the supervision of the hospital clinical engineer or department supervisor. *Preq.* ETIN 253; 1 lec. 14 lab
- ETIN 299 Special Topics in Instrumentation (1-5)** Offered as an elective for instrumentation students. Covers topics of special interest. *Preq. instructor permission*
- ETPL 100 Plastics Manufacturing (3)** An introductory overview of the different plastic resins, processing methods, and terminology. Lectures cover different types of plastic, identification tests, polymerization, molecular growth, and processing methods. Laboratory experiences in extrusion, injection, thermoforming, compression, and other molding and fabricating operations. F; 2 lec. 3 lab
- ETPL 200 Injection Molding (4)** Basic topics in the processing of thermoplastic resins. Hands-on operation of injection molding machines and introduction to principles of injection molding processing of thermoplastics. *Sp; preq.* ETPL 100 or advisor approval; 3 lec. 3 lab
- ETPL 205 Extrusion/Blow Molding (4)** Continuation of ETPL 200. Basic topics in processing; study of the extrusion and blow molding processes of thermoplastic resins. F; *preq.* ETPL 200 or advisor approval; 3 lec. 3 lab
- ETPL 210 Thermoforming/Finishing (4)** Continuation of ETPL 100 and ETPL 205. Basic topics in the thermoforming area and the study of industrial manufacturing methods not encountered in the previous courses. Includes printing, cementing, electroplating, metalizing, hot stamping, polishing, engraving, machining, and other decorating and finishing processes. W; *preq.* ETPL 205 or advisor approval; 3 lec. 3 lab
- ETPL 215 Thermosetting Processes (4)** Study dealing with processing of thermoset materials. Hands-on operation of thermoset molding machines and introduction to principles of processing thermoset resins. *Sp; preq.* ETPL 210 or advisor approval; 3 lec. 3 lab
- ETPL 230 Properties of Polymeric Materials (4)** Basic design considerations in use of polymeric materials. Because of applications-oriented approach, the reasons for using designs and polymers are presented. Extensive usage of tables on properties and shapes. F; *preq.* ETPL 100, CHEM 200, or advisor approval; 3 lec. 3 lab
- ETPL 240 Testing of Plastics (3)** Study of testing materials and the mechanical, thermal, electrical, optical, weathering, flammable, and environmental characteristics of plastic resins. ASTM experiments and written technical reports on the property changes of plastics under various conditions. Introduction of statistical quality control methods as related to material testing. F; *preq.* ETPL 100, MATH 130, or advisor approval; 2 lec. 3 lab
- ETPL 290 Machine Tools (3)** The basics of metal chip making technology. Topics include safety, measurements, bench work, drilling, tuning, shaping, planing, milling, and grinding. Properties and uses of ferrous and non-ferrous alloys, cutting fluids, welding, and foundry practices. Laboratory experiences include chip making processes and tooling methods. F; *preq.* advisor approval; 2 lec. 3 lab
- ETPL 300 Plastics in Society (2)** Study of current trends in policy formation in the plastics industry, including problem solving processes and procedures. Topics include recycling, waste management, public policies, and landfills. F; *preq.* ETPL 100
- ETPL 310 Plant Layout and Material Handling (3)** Principles of plant layout and materials handling, including utilization of workers, materials, and machines for efficient application of all resources. CADD exercises as related to P.L. development. F; *preq.* ETCA 120 or advisor approval; 2 lec. 3 lab

ETPL 320 Production Cost Analysis (3) Understanding the fundamentals of production cost accumulation systems, methods engineering, work measurement, and manufacturing cost control. *Sp; preq. ETPL 100, MATH 132 or equivalent, or advisor approval*

ETPL 330 Material Science (3) Introduction to a broad field of materials, including metals, ceramics, and wood. Emphasis on their nature and behavior to provide a basis for comparison used in the development of new markets for polymers. *F; preq. ETPL 230 or advisor approval; 2 lec. 3 lab*

ETPL 400 Statistical Process/Quality Control 1 (4) Study of probability and statistical theory and the relationships of these concepts to applications in a production environment through statistical process/quality control. *F; preq. MATH 132 or advisor approval; 3 lec. 3 lab*

ETPL 405 Statistical Process/Quality Control 2 (4) Study of the methods used on SQC and SPC, including X bar and R charts (variables), p and np charts (attributes), interpretation of charts, Pareto analysis, Histograms and curve fitting, and Demming's fourteen points for quality. Lab sessions focus on computer analysis of statistical production data. *W; preq. ETPL 400 or advisor approval; 3 lec. 3 lab*

ETPL 410 Applied Statistical Experimentation (4) Study of the methods used in formalized design of experiments. Develops ability to construct, conduct, and analyze a statistically sound experiment. Taguchi's, Plackett's, and Burman's methodologies are studied. Orthogonal arrays, variance, and experiment structure are explored through the use of two software packages designed specifically for D.O.E. *Sp; preq. ETPL 405 or advisor approval; 3 lec. 3 lab*

ETPL 420 Plastics Part Design (3) Study of thermoplastic and thermoset part designs. Assigned projects develop an understanding of design parameters. Emphasis is placed on combining several areas of knowledge to design a plastic part. *F; preq. ETPL 230, 330, ETCA 120, or advisor approval; 2 lec. 3 lab*

ETPL 425 Mold Design and Analysis 1 (4) Development of a mold using the part designed by the student in ETPL 420. Design and analysis of thermoplastic injection molds, extrusion dies, and blow molding using Moldflow Design and Analysis and Cadkey programs. Includes geometric dimensioning, cams, and other special techniques. May include hot runner systems. *W; preq. ETPL 420 or advisor approval; 3 lec. 3 lab*

ETPL 430 Mold Design and Analysis 2 (4) Continuation of ETPL 425. Development of a mold using the part designed by the student in ETPL 420. Design and analysis of thermoplastic injection molds using Moldflow Design and Analysis programs. *Sp; preq. ETPL 425; 3 lec. 3 lab*

ETPL 440 Advanced Manufacturing Techniques (3) Develops the student's ability to recognize and distinguish the following production disciplines: MRP, MRP II, JIT, CIM, MPS, capacity planning, and scheduling. *F; preq. ETPL 215, 310, 320, or advisor approval*

ETPL 450 Advanced Processing 1 (4) A detailed study of the various theories of processing and polymer rheology. Theoretical aspects of material transfer, melting mechanisms, and part formation. *W; preq. ETPL 215, 330, or advisor approval; 3 lec. 3 lab*

ETPL 455 Advanced Processing 2 (4) Continuation of ETPL 450. Integration of previously acquired processing knowledge with the theoretical knowledge acquired in ETPL 450. *Sp; preq. ETPL 450 or advisor approval; 3 lec. 3 lab*

ETPL 460 Composites (3) Provides a unified view of the composite industry. Topics include: raw materials, curing agents, fillers, various fiber reinforcements, and the various processing methods. *F; preq. ETPL 330 or advisor approval; 2 lec. 3 lab*

ETPL 470 Senior Project (4) Provides knowledge necessary to construct a basic plastic mold developed in ETPL 420. Lab experience involves interpretation of tool prints, materials, and processing used in the actual construction of this plastic mold. *F; preq. ETPL 290, 420, 425, and 430; 2 lec. 6 lab*

ETPL 499 Special Topics in Plastics (1-5) Offered as an elective for plastics students. Covers topics of special interest. *Preq. instructor permission*

- ETRO 211 Robotic Interfacing (4)** Study of hardware and software for interfacing programmable controllers, microprocessors, and computer control to a robotic arm with interaction of peripheral machines and equipment. *Preq. ETEM 209 or ETCO 230; 3 lec. 2 lab*
- ETRO 212 Robotic Applications (4)** Advanced study and training in high technology robot operations and applications with emphasis on continuous and controlled path robots, programmable logic control systems, and production systems and operation. Extended practice in off-line programmable set-up, adjustment, and operation of robotic work cells and materials handling systems. *Preq. ETRO 211; 3 lec. 2 lab*
- ETRO 213 Robotic Maintenance & Servicing (4)** Instruction in servicing and troubleshooting robotic and peripheral automated systems. Emphasis on mechanics, hydraulics, and associated electrical and electronics. *Preq. ETRO 212; 3 lec. 2 lab*
- FINA 201 Principles of Finance (4)** A study of the forms of business organization, cash flow projections, budgeting and financial planning, and analysis of financial statements. *F Su; preq. ACCT 102 or 201*
- FINA 240 Personal Finance (4)** Takes the student through the topics of financial planning, budgeting, housing, transportation, insurance, investments, retirement, and estate planning. *F*
- FINA 299 Special Topics in Finance 1 (1-4)** Opportunity for the student to work on special projects under the supervision of an instructor with expertise in the area of the student's project. *Not regularly offered; preq. instructor permission; see special note on page 84.*
- FINA 301 Principles of Insurance (4)** Basic insurance course includes the nature of risk; the legal environment; life, health, income, property liability, business risk, government, and international insurance. *W*
- FINA 304 Investments (4)** A study of various investment alternatives and the general and specific information that must be considered before thought is directed toward specific industries and businesses. Included is the study of the tools and sources needed for analysis in making wise investment decisions. *F; preq. ECON 102 and ACCT 102 or 201*
- FINA 310 Money and Banking (4)** Cross-listed as ECON 310. Development of banking and the role of the Federal Reserve System in the U.S. Analysis of monetary policy for purpose of stabilization. *Sp; preq. ECON 101 and 102*
- FINA 311 Financial Statement Analysis (4)** A detailed study involving the analysis and interpretation of financial information contained in financial reports of various entities, including measurements of the firm's profitability, solvency, and degree of safety. *Not regularly offered; preq. ACCT 103 or 210*
- FINA 315 Financial Institutions (4)** An integrated and comprehensive analysis of financial markets and institutions emphasizing financial intermediaries and their operation in the markets. *Sp; preq. ECON 102, ACCT 102, or 201*
- FINA 345 Managerial Finance (4)** An analysis of financial information for the purpose of facilitating the planning, organizing, and controlling functions of management. Includes financial statement analysis, budgeting, concepts of present and future value, cash flow analysis, and capital budgeting decisions. *F Su; preq. MGNT 310 and ACCT 210*
- FINA 481 International Finance (4)** A survey of the institutions, methods, instruments, and procedures involved in international finance, including the nature of the foreign money market, foreign legal and tax environment, and foreign subsidiary operations. *Not regularly offered; preq. FINA 345*
- FINA 499 Special Topics in Finance 2 (1-4)** Opportunity for the junior or senior student to work on special projects under the supervision of an instructor with expertise in the area of the student's project. *Not regularly offered; preq. instructor permission; see special note on page 84.*
- FREN 111 Elementary French 1 (4)** Beginning course of a three-quarter, first-year sequence. Basic grammatical concepts and patterns. Emphasis is on development of reading, listening, comprehension, speaking, and writing skills. *Su F W Sp*

- FREN 112 Elementary French 2 (4)** Continuation of FREN 111. *W Sp; preq. FREN 111*
- FREN 113 Elementary French 3 (4)** Continuation of FREN 112. *Sp; preq. FREN 112*
- FREN 211 Intermediate French 1 (4)** An intensive review of grammar and sentence structure and introduction to selected readings in French literature. Oral expression is stressed. *Offered on demand; preq. FREN 113*
- FREN 212 Intermediate French 2 (4)** Continued intensive review of grammar. Sight translation is stressed. Conversational drills include advanced idiomatic expressions. *Offered on demand; preq. FREN 211 or instructor approval*
- FREN 213 Intermediate French 3 (4)** Advanced vocabulary and sentence structure are stressed. Emphasis is on writing and free composition. *Offered on demand; preq. FREN 212 or instructor approval*
- GEOG 125 World Geography (4)** Concerns world's regions and nations, resource use, cultural groups, and political patterns. Designed to develop an understanding of world affairs and the applications of geography in general. *F Sp*
- GEOG 130 Economic Geography (4)** Systematic survey of locational economic patterns and their interrelationships. *F W*
- GEOG 201 Cultural Geography (4)** Impact of various cultures on landscape, distribution of cultural traits, ecological adaptations, and cultural areas throughout the world. *F Sp*
- GEOG 225 Physical Geography (4)** Systematic survey of earth-sun relationships, land forms, climate, soils, and natural vegetation. *Su W*
- GEOG 230 Urban Geography (4)** Study of city function, patterns, and past and current problems confronting the city, including planning, zoning, housing, and urban renewal.
- GEOG 242 Geography of Ohio (4)** Detailed regional study of physical background, settlement, and economic development.
- GEOG 243 Geography of Appalachia (4)** A study of Appalachia from a geographical approach, including a detailed examination of physical aspects (climate, soil, vegetation, minerals, and water resources), historical development both past and present, settlement patterns, and economic patterns of the region. *Offered as demand indicates.*
- GEOG 299 Special Topics in Geography (1-4)** Individual or small-group study, under the supervision of instructor, of topics not otherwise available to students. Separate courses, repeatable for credit. *Preq. GEOG 101, 125, 130, or 201*
- GEOG 310 Medical Geography: Geography of Life or Death (4)** Relationship between disease and the physical and socio-economic environ. Topics include disease ecology, historical patterns of cholera and plague, tropical disease, weather and health, cancer and heart disease in the U.S., hunger and the environment, distribution of resources, and introduction to facilities location planning. *Su alternate years, Sp*
- GEOG 311 Air Pollution (4)** Examination of air pollutants and their social and economic impacts, control strategies, and air pollution planning.
- GEOG 350 Regional Geography: Geography of North America (4)** The U.S. and Canada studied from a geographical perspective, including detailed examination of climate, soil, vegetation, minerals, water resources, historical development, settlement patterns, and economic aspects of the region. *W*
- GEOG 351 Regional Geography of the Middle East (4)** The Middle East — a cradle of civilization, birthplace of three world religions, crossroads, oil resource area, site of persistent conflict since WWII. The course addresses these aspects within the context of regional geography. *Sp*

GEOG 399 Special Topics in Geography (1-4) Individual or small-group study, under the supervision of instructor, of topics not otherwise available to students.

GEOG 404 Transportation Geography and Management (4) Examination of the geography of transport routeways and the geographic factors governing their evolution and use. Various modes (e.g. rail, water, highway) are discussed in terms of facilities, environmental impacts, rate structures, and commodities shipped. Decision processes of shippers, carriers, and government are examined. *F alternate years; preq. one course in GEOG or ECON*

GEOG 499 Special Topics in Geography (1-4) Individual or small-group study, under supervision of instructor, of topics not otherwise available to students. Separate courses are repeatable for credit. *Preq. GEOG 125, 130, or 201.*

GEOL 111 Rocks, Minerals, and Fossils (4) Introduction to earth materials. Strong emphasis on laboratory identification of rocks, minerals, and fossils. Lecture topics include several key earth processes and important geologic theories. Course includes laboratory assignments and a field trip to fossil localities near Portsmouth. *F W; 3 lec. 2 lab*

GEOL 112 Environmental Geology (4) Analysis of complex interaction between Earth and man. Emphasis on natural hazards such as floods, earthquakes, volcanic eruptions; waste disposal; and groundwater, mineral, and energy resources. Course includes laboratory assignments and a field trip. *F Sp; 3 lec. 2 lab*

GEOL 201 Physical Geology (4) Introduction to earth materials and the processes that shape the Earth's surface. Emphasis on important earth processes such as volcanism, weathering, glaciation, and earthquakes; and theories which have modified our explanation of geologic phenomena. Course includes laboratory assignments and a field trip to Hocking Hills. *F W; 3 lec. 2 lab*

GEOL 202 Historical Geology (4) The history of the Earth and its inhabitants. Emphasis on major physical and biological events that have profoundly affected the Earth, on causal mechanisms of geological events, and on the theories that have changed our interpretation of the Earth's history. Course includes lecture, lab, and field trip to localities in southern Ohio. *W; preq. GEOL 201 or instructor permission; 3 lec. 2 lab*

GEOL 290 Seminar in Geology (1-4) Discussion of advanced topics in geology.

GEOL 295 Independent Study (1-4) Independent geology investigation, under the direction of a faculty member.

GEOL 299 Special Topics in Geology (1-4) Individual or small-group study, under the supervision of instructor, of topics not otherwise available to students.

GEOL 301 Invertebrate Paleobiology (4) An introduction to major groups of invertebrates that are commonly preserved in rocks. Emphasis on preservation, morphology, collection, and geological and biological significance of invertebrate micro- and mega-fossils. *Sp odd years; preq. GEOL 202 or instructor permission; 3 lec. 2 lab*

GEOL 303 Sedimentary Rocks (4) Advanced study of siliciclastic and carbonate rocks. Emphasis on interpretation of depositional environments of sedimentary rocks by using modern analogues. *Sp even years; preq. GEOL 202 or instructor permission; 2 lec. 2 lab*

GEOL 390 Seminar in Geology (1-4) Discussion of advanced topics in geology.

GEOL 401 Field Methods (4) Study and use of the essential methods of field observations, description, and mapping. Course consists of lecture and detailed field projects in the Portsmouth area. *F odd years*

GEOL 485 Senior Project (1-4) In-depth study of a selected topic in geology, culminating in the preparation of a senior paper. *Preq. junior or senior standing*

GEOL 490 Seminar in Geology (1-4) Discussion of advanced topics in geology. *Preq. junior or senior standing*

GEOL 495 Independent Study (1-4) Independent geology investigation, under the direction of a faculty member. *Preq. junior or senior standing*

GEOL 499 Special Topics in Geology (1-4) Individual or small-group study, under the supervision of instructor, of topics not otherwise available to students. *Preq. junior or senior standing*

GOVT 101 National Government (4) An analysis of the constitutional basis and development of American politics in light of classical democratic theory and contemporary practices; emphasis on the structures, processes, and functions of the national government. *F*

GOVT 102 National Policy Issues (4) Study of the politics of policy formation and implementation by the national government in selected areas (e.g., foreign policy, welfare, political economy, and environment.) *W*

GOVT 199 Special Topics in Government (1-4) Individual or small-group study, under the supervision of instructor, of topics not otherwise available to students. Repeatable for credit. *Offered by arrangement*

GOVT 240 Contemporary Political Ideologies (4) A survey of political thinking, movements, and regimes. Examines the relationship between political visions and the shaping of attitudes, beliefs, and political practice. *One session, offered fall quarter, 1993*

GOVT 250 Introduction to Political Science (4) This course, required for all social science majors, explains the fundamentals of the field of political science and offers introductory treatments on the four sub-fields of the discipline (i.e., political theory, comparative politics, international relations, and American government). *F W Sp*

GOVT 270 Global Politics (4) Emphasis on international conflict and cooperation, interdependency, and the increasing importance of economic and transnational relations in the contemporary world. A critical examination of a variety of analytic concepts concerning types of international systems and political behavior. *One session, offered winter quarter, 1994*

GOVT 299 Special Topics in Government (1-4) Individual or small-group study, under the supervision of instructor, of topics not otherwise available to students. Repeatable for credit. *Offered by arrangement*

GOVT 310 United States Foreign Policy (4) The conceptual bases underlying the development of post-World War II foreign policy, its changing concerns, and its various modes of policy implementation in selected cases and geographic areas (e.g., the Cold War, the Third World, and North/South issues.)

GOVT 320 Third World Politics (4) The individual and collective study of the causes of development and underdevelopment, crisis politics, and the prospects for the future of nations in Asia, Latin America, and Africa. *W*

GOVT 330 Mass Media Politics (4) A study of the globalization of the media and its effects on local, national, and international politics; economics; and socialization processes in the United States and other nations. *W*

GOVT 340 European Politics (4) Examines the historical, political, and economic realities of selected nations from an individual and a cross-national perspective with additional attention to the current European Economic Community's supranational integration development process. *One session, offered spring quarter, 1994*

GOVT 399 Special Topics in Government (1-4) Individual or small-group study, under the supervision of instructor, of topics not otherwise available to students. Repeatable for credit. *Offered by arrangement*

GOVT 401 State of the World (4) A critical analysis of the relationship between humans and their physical environment at the local, regional, and global level. Surveys issues, identifies problems, and examines actual and possible solutions pertinent to this relationship by utilizing an interdisciplinary approach incorporating students' backgrounds from previous social science courses. Required course for all social science majors. *Sp F; preq. junior standing*

- GOVT 420 International Political Economy (4)** Historical development of the world economy from 1700s to the present with emphasis on international and transnational actors and institutions, dependency and imperialism, and other selected issues and problems (e.g., trade, debt, and finance). *One session, next offered fall quarter, 1994; preq. junior standing*
- GOVT 499 Special Topics in Government (1-4)** Individual or small-group study, under the supervision of instructor, of topics not otherwise available to students. Repeatable for credit. *Offered by arrangement; preq. eight hours GOVT*
- HIST 111 American History to 1828 (4)** Exploration and colonization; political, social, and economic life of the English colonies to 1763; struggle for independence; constitutional development and the Federalist era; Jeffersonian democracy and the War of 1812; rise of Jackson. *F*
- HIST 112 American History, 1828-1900 (4)** Jacksonian democracy, territorial expansion, growth of sectionalism, Civil War, reconstruction, impact of expanded Industrial Revolution. *W*
- HIST 113 American History Since 1900 (4)** Progressive movement, WWI, Republican prosperity, the Great Depression and the New Deal, WWII and problems of the cold war era, turmoil and reform in the 1960's, crisis of confidence in the 1970's, and renewal in the 1980's. *Sp*
- HIST 199 Special Topics in History (1-4)** Individual or small-group study, under the supervision of instructor, of topics not otherwise available to students.
- HIST 201 Ancient History (4)** A survey of antiquity from the rise of civilization in ancient Sumeria and Egypt to the end of the Roman empire. *F*
- HIST 202 Medieval and Early Modern Europe (4)** A survey of European history from the beginning of the Middle Ages to 1789. *W*
- HIST 203 Modern Europe (4)** A survey of European history from the French Revolution to the present. *Sp*
- HIST 225S Civilization and Literature 1 (4)** Cross-listed as ENGL 225S. General education core requirement. Part of a three-course sequence designed to introduce students to western, American, and non-western cultures. This course is an interdisciplinary introduction to the major thoughts important in the development of western civilization. *Su F W Sp*
- HIST 226S Civilization and Literature 2 (4)** Cross-listed as ENGL 226S. General education core requirement. An interdisciplinary introduction to the major thoughts important in the development of American civilization. *Su F W Sp*
- HIST 227S Civilization and Literature 3 (4)** Cross-listed as ENGL 227S. General education core requirement. An interdisciplinary introduction to the major thoughts of various non-western civilizations. *Su F W Sp*
- HIST 260 East Asian History (4)** A survey of the history of China and Japan. *Offered on demand*
- HIST 299 Special Topics (1-4)** Separate courses repeatable for credit. *Preq. HIST 111, 112, and 113, or HIST 201, 202, and 203*
- HIST 301 Formation of the American Nation, 1750-1815 (4)** Causes and consequences of the American revolution, Confederation period and establishment of new constitutional order, survival and development of the republic in an unfriendly world, 1789-1815. *Offered on demand; preq. HIST 111 or instructor permission*
- HIST 305 From FDR to Reagan (4)** A survey of domestic history from the New Deal to the present. The Great Depression and the New Deal, domestic consequences of World War II and the Cold War, reform efforts of the 1960's, Vietnam trauma, exhaustion of liberalism in the 1970's. *Offered on demand; preq. HIST 113 or instructor permission*

HIST 310 Nazi Germany (4) An examination of Adolph Hitler, Nazi ideology, World War II, the concentration camps, and genocide. *Offered on demand*

HIST 320 History of American Foreign Relations (4) A survey of U.S. foreign relations since 1914. World War I and the Versailles Treaty, interwar efforts to avoid the responsibilities of hegemony, World War II diplomacy and the origins of the cold war, Soviet-American conflict in the Third World, Vietnam War and efforts at detente, exhaustion of the cold war in the 1980's, and possible "end of history." *Offered on demand; req. HIST 113 or instructor permission*

HIST 325 History of Russia (4) An overview of Russian history since the Age of Peter the Great. Emphasis on the period from the Crimean War to the present, examining the ambivalent modernization efforts of the late Empire, the collapse of the autocracy in WWI, and subsequent triumphs and travails of the Soviet Experiment. *Offered on demand; req. HIST 203 or instructor permission*

HIST 330 History of Southern Africa (4) A survey of the African and European experiences in southern Africa from the 17th Century to the present. *Offered on demand*

HIST 399 Special Topics in History (1-4) Individual or small-group study, under the supervision of instructor, of topics not otherwise available to students.

HIST 401 History of Medicine (4) An in-depth survey of the history of medicine from antiquity to the modern era. Topics include shamanism and magical methods of healing, exorcism, Chinese acupuncture, classical Greek medicine, and the rise of modern dentistry, obstetrics, surgery, and psychiatry. *F*

HIST 410 Intellectual History 1 (4) Part one of a course examining humanity's ideas about the cosmos, the earth, and the human species. Topics in this course include creation myths, the history of astronomy, concepts of the afterlife, and the ideas about "imaginary places" (from Atlantis to Shambala). *W*

HIST 411 Intellectual History 2 (4) Topics in this course include the history of geology and ideas about the earth, "creation of man" legends and the ideology of Darwinism, "the devil, the Antichrist, and perceptions of evil," ideas about "imaginary creatures" (from unicorns to vampires), and scientific theories about the "end of the world." *Sp*

HIST 420 Middle East in Modern Times (4) An examination of recent conflicts and turmoil in the Middle East through the following sequence: concise overview of Middle East history, relationships between today's turmoil and the development of nationalism and emergence of nation-states, specific conflicts like the Soviet invasion of Afghanistan, Arab-Israeli conflict, and the Gulf war. *Offered on demand*

HIST 499 Special Topics in History (1-4) Individual or small-group study, under the supervision of instructor, of topics not otherwise available to students. Separate courses repeatable for credit. *Req. HIST 111, 112, and 113, or HIST 201, 202, and 203*

HPER 101 First Aid and CPR (2) Cross-listed as EMTP 101. Includes the American Red Cross Standard First Aid Course related to bleeding control, obstructed airway management, splinting and bandaging techniques, and other emergency care procedures. Also includes the American Red Cross Adult CPR course. American Red Cross Standard First Aid certification and Red Cross Adult CPR certification are granted upon successful completion of course.

HPER 102 CPR (1) Cross-listed as EMTP 102. Techniques of cardiopulmonary resuscitation. American Red Cross or American Heart Association CPR certification is granted upon successful completion of this course.

HPER 103 Introduction to Human Nutrition (2) Study of nutrients, nutritional diets, deficiencies, and the role of nutrition in promoting health. *F*

- HPER** **Physical Education Activities (1)** Basic rules and fundamentals for each of the following activities. Special emphasis on strategies, team, and individual play. An appreciation of each of the activities is developed to carry over into later life.
- HPER 105 Archery *F W Sp*
 HPER 111 Basketball *W Sp*
 HPER 113 Billiards *F W Sp*
 HPER 115 Bowling *F W Sp*
 HPER 117 Volleyball *F W Sp*
 HPER 119 Walleyball *Su F W Sp*
 HPER 120 Beginning Golf *Su F Sp*
 HPER 121 Intermediate Golf *Sp*
 HPER 122 Handball *F*
 HPER 124 Softball *Sp*
 HPER 130 Beginning Racquetball *Su F W Sp*
 HPER 131 Intermediate Racquetball *F W Sp*
 HPER 132 Advanced Racquetball *Sp*
 HPER 140 Beginning Tennis *Su F Sp*
 HPER 141 Intermediate Tennis *Su Sp*
 HPER 142 Advanced Tennis *Su Sp*
 HPER 149 Badminton *F*
 HPER 150 Swimming *Su F W Sp*
 HPER 151 Intermediate Swimming *Su F W Sp*
 HPER 152 Life Saving *Su F W Sp*
 HPER 153 Advanced Life Saving *Su F W Sp*
 HPER 154 Life Guard Training *Su F W Sp*
 HPER 155 Advanced Swimming *Su F W Sp*
 HPER 156 Fitness Swimming *F*
 HPER 157 Swimmercize *F W Sp*
 HPER 158 Diving *F Sp*
 HPER 159 Water Volleyball *Sp*
 HPER 160 Dance *F W Sp*
 HPER 162 Yoga *Su F W Sp*
 HPER 162 Advanced Yoga *Su F W Sp*
 HPER 165 Beginning Gymnastics *F*
 HPER 170 Karate *Su F W Sp*
 HPER 171 Judo *Sp*
 HPER 172 Women's Self Defense *F W Sp*
 HPER 180 Jogging *Su F Sp*
 HPER 181 Skiing *W*
 HPER 182 Orienteering *F Sp*
 HPER 183 Rock Climbing *F Sp*
 HPER 184 Caving *F Sp*
 HPER 185 Backpacking *F Sp*
 HPER 186 Cycling *Su F Sp*
 HPER 187 Conditioning and Weight Training *Su F W Sp*
 HPER 188 Conditioning and Weight Training/Nautilus *Su F W Sp*
 HPER 189 Horseback Riding
 HPER 190 Beginning Scuba *F*
 HPER 191 Scuba—Open Water *W*
 HPER 197 Canoeing *Sp*
- HPER 200 **Introduction to Recreation (3)** A study of the general concepts of recreation, including definitions, history, legal basis, current development, and present importance of recreation in our society. Management and administration of parks and recreation organizations. Laboratory introduction to a number of recreation experiences. *F W Sp*;
 3 lec. 3 lab

HPER 202 Personal and Community Health (4) Fundamentals, practices, and appreciation of healthful living. Designed to incorporate the principles of scientific health information and promote desirable attitudes and practices in individuals, parents, and teachers. *Su F W Sp*

HPER 203 Human Nutrition (4) A study of nutrients, including sources, composition, function, and metabolism in the human body. The human life cycle is considered in planning appropriate diets. *Su F W Sp*

HPER 220 Introduction to Athletic Training (3) Introduction to prevention, treatment, care, and rehabilitation of athletic injuries. *Su F Sp*

HPER 222 Practicum Sportsmedicine (2) Study of strapping and taping techniques, construction of orthotics and orthopedic appliances, and fitting protective equipment commonly used in the profession of sportsmedicine. *Su W*

HPER 227 First Aid (4) The standard and personal safety American Red Cross first aid course, involving CPR, bleeding control, shock treatment, proper methods of transportation, bandaging, and splinting. The course involves lectures, practical work, and group work. The standard American Red Cross certificate, as well as CPR certification, is granted if at least 20 hours of classwork are completed and all requirements are met. *F W Sp*

HPER 234 Laboratory Experience in Physical Education (2) Observation and research in physical education in the elementary and secondary levels. *F W Sp arranged*

HPER 235 Orientation to Recreation Employment (1) Resume writing, job application, interviewing, contact follow-up, letter writing, job hunting strategies, and potential employers. *Sp; 1 lec. 1 lab*

HPER 236 Field Experience in Recreation (2-6) Supervised work experience while gaining skills and knowledge in the field of recreation.

HPER 239 Athletic Officiating—Football (3) Rules, mechanics, and procedures in officiating. Practice under actual game conditions. State certification upon successful completion of state examination. OHSSA fee for certification and books. *F*

HPER 240 Athletic Officiating—Basketball (3) Rules, mechanics, and procedures in officiating. Practice under actual game conditions. State certification upon successful completion of state examination. OHSSA fee for certification and books. *W*

HPER 241 Athletic Officiating—Baseball (3) Rules, mechanics, and procedures in officiating. Practice under actual game conditions. State certification upon successful completion of state examination. OHSSA fee for certification and books. *Sp*

HPER 242 Athletic Officiating—Volleyball (3) Rules, mechanics, and procedures in officiating. Practice under actual game conditions. State certification upon successful completion of state examination. OHSSA fee for certification and books. *F*

HPER 245 Introduction to Coaching (2) Introduction to high school interscholastic athletics, including history, structures, job opportunities, and contemporary programs. *F W Sp*

HPER 250 Recreation Leadership (4) Lectures, discussion, and group dynamics in social recreation, including games, sports skills, dance, arts and crafts, nature studies, setting up various types of tournaments, and practical work in community organizations. *F W Sp*

HPER 252 Youth and Sports (3) Exploration of opportunities, controversies, organization, safety, values, rules, leadership, benefits, and settings of youth sports programs. *Sp*

HPER 255 Aquatic Recreation Leadership (4) Study of water-related recreational facilities such as marinas, swimming areas, and fishing. Consideration is given to boating laws, boat operation and safety, and all forms of water recreation. *F W Sp; 2 lec. 6 lab*

- HPER 260 Outdoor Recreation (4)** Several aspects of outdoor recreation, including concepts of feasibility, interpretation, and personal recreation equipment use and care. Laboratory exercises. *F Sp; Coreq. HPER 200 or permission of instructor; 2 lec. 6 lab*
- HPER 261 Introduction to Physical Education and Health (2)** Lectures, discussion, and visual aids pertaining to scope and content of a professional physical educator.
- HPER 270 Physical Education for the Elementary Classroom (4)** Lab and lecture experience for teaching physical education in the elementary schools. Lab experience revolves around methods of presenting games, self-testing activities, rhythmic, and innovative devices in the elementary grades. Designed for elementary education majors. *F W Sp; Preq. EDUC 110*
- HPER 281 Administration of Intramural Athletics (4)** Organizing and administering a program of intramural sports for all age levels. Designed especially for elementary and secondary teachers. *F W; Preq. Ed. and P.E. majors/minors*
- HPER 295 Independent Study (2)** Study, observation, and research in selected physical education fields. Under the direction of HPER faculty member. *Su F W Sp; Preq. upper division HPER classes*
- HPER 320 Advanced Athletic Training (3)** Development of competencies in the prevention, treatment, care, and rehabilitation of athletic injuries. *Su W Sp; Preq. HPER 220*
- HPER 322 Advanced Sportsmedicine 1 (4)** Study of techniques in evaluating, preventing, and managing common lower body injuries and illnesses in athletics. *Su W Sp; Preq. HPER 222*
- HPER 325 Rehabilitation of Athletic Injuries (3)** Study of principles and procedures of therapeutic exercises. Topics include muscle testing, goniometry, flexibility, and progressive resistance exercises in the rehabilitation of common injuries occurring in athletics. *Su W Sp; Preq. HPER 320*
- HPER 326 Therapeutic Modalities in Sportsmedicine (3)** Theory and therapeutic application of modalities such as cryotherapy, thermotherapy, low and high volt electrical currents, diathermy, intermittent compression, traction, and massage in the rehabilitation of athletic injuries. *Su W Sp; Preq. HPER 320*
- HPER 340 Coaching of Volleyball (2)** Theory of coaching volleyball. Analysis of skills, strategies, methods, duties, and responsibilities. *F*
- HPER 341 Coaching of Basketball (2)** Theory of coaching basketball. Analysis of skills, strategies, methods, duties, and responsibilities. *W*
- HPER 342 Coaching of Football (2)** Theory of coaching football. Analysis of skills, strategies, methods, duties, and responsibilities. *F*
- HPER 343 Coaching of Track (2)** Theory of coaching track. Analysis of skills, strategies, methods, duties, and responsibilities. *Sp*
- HPER 344 Coaching of Softball (2)** Theory of coaching softball. Analysis of skills, strategies, methods, duties, and responsibilities. *Sp*
- HPER 360 Drugs/Substance Abuse (4)** Cross-listed as PSYC 360 and SOCI 360. An in-depth study of alcohol, tobacco, and other drugs and how chemical dependency on these drugs can affect individual performance and behavior. *Su F W Sp*
- HPER 420 Physiology of Exercise (4)** Study of the physiological response of the cardiovascular, respiratory, endocrine, neural, and muscular systems in the human body during exercise. *Su Sp; Preq. BIOL 162*
- HPER 422 Advanced Sportsmedicine 2 (4)** Study of techniques in evaluating, preventing, and managing common upper body injuries and illnesses in athletics. *Su Sp; Preq. HPER 222*
- HPER 495 Special Topics (2-4)** Independent research project of an individual topic in the field of sportsmedicine, recreation, or physical education. *Su Sp*

HUMN 201 Tradition of Great Books 1 (4) Classics of ancient Greek, Roman, and Hebrew. Discussion and practice in critical thinking, reading, and writing about these great works.

HUMN 202 Tradition of Great Books 2 (4) Classics from the ancient world, middle ages, age of reason, and Romantic period.

HUMN 203 Tradition of Great Books 3 (4) Classics of the ancient world and middle ages and writings of more recent times, including the present.

JOUR 105 Introduction to Mass Communication (4) Introduces all forms of mass communication, including newspapers, magazines, radio/television, book publishing, public relations, advertising, and photojournalism. Begins with an analysis of the communication process and ends with media career opportunities. *Offered on demand*

JOUR 199 Topics in Journalism (4) Study of selected newspaper topics not otherwise available. Includes hands-on experience in various newspaper positions. *Offered on demand*

JOUR 231 News Reporting and Writing (4) Methods of gathering and evaluating news and writing news stories. Practice work includes covering assignments and writing news copy. *Offered on demand; req. typing proficiency*

JOUR 289 Magazine Feature Writing (4) Writing and marketing free-lance magazine articles of various types, including personal narrative, informative, how-to, historical, personality sketch, investigative, and interpretative. Students learn how to generate ideas, get photos, propose article ideas to editors, and survey regional and specialty magazine markets. *Offered on demand*

JOUR 299 Topics in Journalism (3) Study of various topics in journalism not otherwise available to students. *Offered on demand*

LAST 101 Introduction to Legal Assisting (4) Practical introduction to the career of paralegalism. Describes the drafting, digesting, interviewing, investigating, and research skills required to be an effective paralegal or legal assistant. *Su F W Sp*

LAST 212 Real Estate Law for Legal Assistants (4) Provides the essential substantive and practical skills necessary for a legal assistant to participate effectively in real estate transactions. Introduces real property concepts and examines the component parts of a real estate transaction, including entering into the purchase contract, providing a legally sufficient description of the property, preparing the deed, addressing the property's state of title, and conducting the closing. *Not regularly offered; req. LAST 101*

LAST 251 Legal Research and Writing 1 (4) Employs a step-by-step approach in introducing students to the legal system, interpreting court opinions and applying opinions in legal writing. Emphasis is on the study of court opinions through "key fact" identification and using these facts in the application process. *Su F W Sp; req. LAST 101 and ENGL 111S*

LAST 252 Legal Research and Writing 2 (4) A thorough overview of legal research and writing techniques. Covers information on citing cases, finding case law, and interpreting statutes. Instructs students in computer-assisted legal research, using LEXIS. *Su F W Sp; req. LAST 251*

LAST 253 Legal Research and Writing 3 (4) A continuation of the study of legal research and writing, with an emphasis on gaining greater familiarity with a variety of primary and secondary legal authorities and with LEXIS. *Not regularly offered; req. LAST 252*

LAST 261 Tort Law: Personal Injury Litigation (4) Presents an overview of tort law oriented to paralegals. Specific skill assignments in research analysis, drafting, investigation, and interviewing. Students can relate the law outlined in the book to the specific law of a particular state. *Not regularly offered; req. LAST 101*

LAST 262 Introduction to Civil Litigation (4) An introduction to the legal system of dispute resolution in noncriminal matters. Focuses on the process of civil litigation rather than on substantive legal issues. Explains the paralegal's role in interviewing clients, drafting pleadings and pretrial motions, conducting discovery, and preparing for trial. Contains examples of actual documents drafted by paralegals. *Not regularly offered; req. LAST 101*

LAST 263 Introduction to Contracts and Restitution (4) Introduces the laws of contracts and restitution with emphasis on applying the concepts presented to contract analysis and formation. Chapters present the rules of law, examples of how the rules apply to facts, and problems that help students apply the rules. Cases are examined to show how the courts apply the rules. *Not regularly offered; preq. LAST 101*

LAST 264 Computer Application and the Law (3) Provides students and legal professionals with the minimum knowledge about computers that they will need to work efficiently in today's automated law practice. *Su F W Sp*

LAST 265 Family Law (4) Comprehensive overview of family law for the nonlawyer. Practice-oriented text teaches students the skills and techniques in investigation and analysis and includes detailed coverage of child custody, contract cohabitation, property division, and support enforcement laws. *Not regularly offered; preq. LAST 101*

LAST 266 Wills, Trusts, and Estate Administration (4) A paralegal course in probate or estate administration. Contains updated tax laws and tax forms affecting wills and estates. *F Sp; preq. LAST 101*

LAST 267 Legal Assisting Practicum (4) Basic on-the-job training. Students are placed in businesses where their acquired skills can be utilized and tested. This training is closely supervised by the instructor. *F W Sp; preq. 24 credit hours of LAST, including LAST 252; 2.0 cumulative grade point ratio in all coursework and in LAST; and permission of instructor.*

LAST 268 Law Firm Procedure and Management (4) A "how-to" guide for handling all of the administrative functions and routine legal matters in a law office as efficiently and economically as possible through the proper use of non-lawyers, so that the lawyer may free his/her time for the handling of challenging legal tasks. *Not regularly offered; preq. LAST 101*

LAST 269 Criminal Law/Criminal Procedure (4) Basic elements of criminal law and procedure dealing with the interpretation and recognition of the use of the criminal code. Assistance with all aspects of the pretrial through posttrial process. This includes investigations, motions, preparation, and research. Research assignments expand the student's skills in this area. *Not regularly offered; preq. LAST 101*

LAST 270 Evidence (4) Introduces the importance of obtaining evidence through fact investigation and develops skills in discovering and organizing facts for use in litigation. *Not regularly offered; preq. LAST 101*

LAST 271 Legal/Medical Terminology and Applications (3) Introduction to the proper procedures for preparing medical reports, clinical reports, and various types of legal documents. An extensive list of medical and legal terms is utilized. This course is structured around the microcomputer. *Not regularly offered; preq. LAST 269*

LAST 272 Ethics for the Legal Assistant (4) This course gives the student a look at the ABA Code and Rules of Professional Conduct, accepted nationally as the ethical expectations for legal professionals; the case law that has developed on the Codes and Rules; and standards aimed specifically at legal assistants. *Not regularly offered.*

LAST 299 Special Topics in Legal Assisting (1-4) Individual or small-group study, under the supervision of an instructor, of topics not otherwise available to students. *Not regularly offered; preq. LAST 101; see special note on page 84.*

LING 270 Introduction to Language and Linguistics (5) Cross-listed as ENGL 360. An introduction to the fundamental properties and processes of the world's languages. A review of the major systems and features which constitute language. A discussion of language change, typology, and aspects of language acquisition. *F Sp*

LING 362 Patterns of English (4) Cross-listed as ENGL 362. A survey of various components of English phrase, clause, and sentence structure and an examination of questions of usage. *F W; suggested preq. LING 270*

LING 365 History of English (4) Cross-listed as ENGL 365. A survey of the patterns and events which have shaped the English language from the time of the Anglo-Saxon to the present. *W Sp; suggested preq. LING 270*

MATH 099 Fundamental Mathematics (4) A brief review of the fundamentals of arithmetic, including addition, subtraction, multiplication, and division of integers and rational numbers. An introduction to the elementary concepts of basic algebra with emphasis on manipulations of algebraic expressions, solutions to simple equations, graphs, and formula rearrangement. (Does not count toward a degree.) *Su F W Sp; preq. placement*

MATH 101 Basic Algebra (4) A course for students with a good background in arithmetic but little or no background in algebra. Operations with integers, number properties, scientific notation, solving linear equations and inequalities and graphing the solutions on real line, operations with polynomials, laws of exponents, and an introduction to square roots. *Su F W Sp; preq. placement or MATH 099*

MATH 105 Plane Geometry and Algebra (4) A course for students with a good background in algebra but little or no background in geometry. Graphing; logical thinking; problem-solving; measurement; area; perimeter and volume of common geometric figures; properties of lines and polygons; and work at a more advanced level with algebra, including work with geometrically related topics. *Su F W Sp; preq. placement or MATH 101*

MATH 110S Mathematics Core Course (4) This course addresses questions about the nature and historical development of mathematical thought and knowledge and the impact of mathematics on modern life. The course focuses on problem solving techniques, heuristics, critical thinking, and the collection and interpretation of data. In addition, one or more of the following topics is included: probability, statistical inference, symbolic logic, graph theory, numeration systems, measurement, basic programming, linear programming, and spreadsheet software with business applications. *Su F W Sp; preq. placement or MATH 105; 3 lec. 1 discussion/activity*

MATH 120 Elementary Topics in Mathematics 1 (5) Problem-solving, sets, concepts of logic, binary operations, systems of numeration, number theory, rational numbers, real numbers, measurement, and use of calculators and computers. *Su F W Sp; preq. MATH 110S*

MATH 121 Elementary Topics in Mathematics 2 (5) Basic algebraic work with equations and inequalities in one unknown, systems of equations, metric and nonmetric geometry, coordinate geometry, introduction of statistics and probability, problem-solving, and computer use. *Su F W Sp; preq. MATH 120*

MATH 125 Business Mathematics (4) Emphasis on estimating answers, percentages, reconciliation of a checking account, mark-up, taxes, depreciation, payroll and payroll deductions, inventory evaluation, financial statements, simple and compound interest on investments and loans, and use of calculators. *F W Sp; preq. placement or MATH 101*

MATH 130 College Algebra 1 (4) This is the first course in the college algebra sequence and includes algebraic techniques, starting with real numbers operations; properties of exponents and radicals; algebraic expressions such as polynomials and rational expressions and their operations; linear equations and inequalities in one and two variables; absolute value inequalities; quadratic equations; right triangle trigonometry and the law of sine and cosines; and systems of equations in two and three variables. *Su F W Sp; preq. placement or MATH 105*

MATH 131 College Algebra 2 (4) Second in the algebra sequence, this is essentially a precalculus course. Definition and operation of functions are introduced. Various classes of functions, such as linear functions, quadratic functions, polynomial functions, rational functions, and exponential and logarithmic functions are discussed. *Su F W Sp; preq. placement or MATH 130*

MATH 132 Trigonometry and Analytic Geometry (4) Third and last in the algebra sequence, this is also essentially a precalculus course. It is an in-depth study of trigonometry, including the definition of the trigonometry of general angles, graphs, trigonometric identities, and trigonometric equations. Topics also include conic sections and parametric equations, as well as the binomial theorem, simple sequences, and series. *Su F W Sp; preq. placement or MATH 131*

- MATH 150 Principles of Statistics (4)** Cross-listed as PSYC 150 and SOCI 150. Introduction to the vocabulary, concepts, formulas, and presentation of statistics as applied to business, education, and science. Topics include measures of central tendency and dispersion, definition of classical probability, probability distributions with emphasis on Binomial and Normal distribution. Sampling practices and theory, calculator and computer use. *Su F W Sp; req. placement or MATH 101*
- MATH 201 Calculus 1 (4)** The first course in the calculus sequence. The main topics are limit theory and differential calculus of one variable functions with an introduction to integration. Contents include functions and limits, differentiation, properties and application of derivatives, the fundamental theorem of calculus. *Su F W Sp; req. placement or MATH 131*
- MATH 202 Calculus 2 (4)** Second course in the calculus sequence. The emphasis is on integration. Contents include integration of algebraic functions and applications and differentiation and integration of exponential, logarithmic, trigonometric, and hyperbolic functions. *Su F W Sp; req. MATH 132 and 201*
- MATH 203 Calculus 3 (4)** The third course in the calculus sequence. Indeterminate forms, improper integrals, Taylor's Formula and infinite series, plane curves, and polar coordinates. Introduction to vectors. *Su F W Sp; req. MATH 202*
- MATH 204 Calculus 4 (4)** The last course in the calculus sequence. The emphasis is on multivariable calculus. Contents include some discussion and applications of vector-valued functions, partial derivatives, multiple integrals, and other topics in vector calculus. *Su F W Sp; req. MATH 203*
- MATH 220 Discrete Mathematics (4)** Introduces the student to various topics from discrete mathematics. Topics include logic; induction; sets, binary relations, and functions; graph theory; proofs; combinatorics and finite probability. *Su W Sp; coreq. MATH 131*
- MATH 230 Linear Algebra (5)** Solutions to linear systems, matrices and matrix algebra, determinants, n-dimensional real vector spaces and subspaces, linear mappings, diagonalization. Techniques and computational skills emphasized. *Su W Sp; req. MATH 132 and 201*
- MATH 250 Statistics 1 (4)** Applications of probability distributions with emphasis on Binomial, Poisson, and Normal and of hypothesis testing for one and two population means and variances; tests of goodness of fit and independence; experimental design and analysis of variance. Calculator, computer, and statistics software used in student project applications. *Su F W Sp; req. MATH 201 (preferably with a grade of "C" or better)*
- MATH 290 Seminar in Mathematics (1-4)** Discussion of topics in mathematics.
- MATH 299 Special Topics in Mathematics (1-4)** Individual or small-group study, under the supervision of instructor, of topics not otherwise available to students.
- MATH 300 History of Mathematics (4)** Survey from Babylonian and Egyptian mathematics to 20th century mathematics with emphasis on development of algebra, geometry, and number theory. *W 1994; req. MATH 132, 201, or permission*
- MATH 301 Ordinary Differential Equations (4)** An introduction to ordinary differential equations with emphasis on technique and application. Topics include existence and uniqueness of solutions, first order equations, linear differential equations, and systems. Analytical and numerical methods. *F 1993 W 1995; req. MATH 203*
- MATH 305 Mathematics Enrichment for the Teacher (4)** The use of manipulative models in the classroom. Computer software selection and its integration into the curriculum. Introductory programming. An introduction to mathematics games and how to use them in teaching mathematics to children. *F Sp; req. MATH 121 or permission*
- MATH 320 Foundations of Geometry (4)** Introduction to axiomatic mathematics through a variety of geometry types, including a consideration of the postulates of Euclid, surface topology, and finite geometry. The development of plane Euclidean and non-Euclidean geometries using appropriate models and the consideration of various geometric configurations. *W 1995; req. MATH 201*

MATH 325 Introduction to Number Theory (4) Selected number systems. Investigation of properties of natural numbers. Topics include proof techniques, prime factorization, Euclidean algorithm, Diophantine equations, congruences, and divisibility. F; *preq.* MATH 201 and 220

MATH 335 Intermediate Analysis (4) In-depth study of limits, sequence, series, continuity, mean-value theorem, differentiation, and Riemann integration. F 1993; *preq.* MATH 203

MATH 350 Statistics 2 (4) Applications of experimental design and analysis of variance, nonparametric tests, linear regression and correlation, multiple regression, time series analysis and forecasting, decision theory. Calculator, computer, and statistics software used in student project applications. Sp; *preq.* MATH 250

MATH 360 Introduction to Probability (4) Classical probability, probability theory, conditions of probability, random variables and distribution, characteristic function, central limit theorem, and Law of Large Numbers. W 1994; *preq.* MATH 203

MATH 410 Modern Algebra 1 (4) Treatment of groups, permutations, subgroups, isomorphisms, homomorphisms, and quotient groups. W 1994 F 1994; *preq.* MATH 230; MATH 335 also recommended.

MATH 411 Modern Algebra 2 (4) Treatment of rings and fields, subrings, ideals, homomorphisms, isomorphisms, and Galois theory. Sp 1994 W 1995; *preq.* MATH 410

MATH 420 Matrix Theory (4) Brief review of Linear Algebra. Matrix functions and applications, including linear programming, inner products, diagonalization, generalized inverses, and applications to differential equations and optimization. Numerical linear algebra. Sp; *preq.* MATH 230 or permission

MATH 430 Numerical Analysis (5) Polynomial interpolation and approximation, numerical integration and differentiation, numerical solution to differential equations. Computer use emphasized. This course is strongly recommended for those who are interested in or would like to pursue a career in applied mathematics, actuarial or computer sciences. Sp; *preq.* MATH 202 and one computer programming language; MATH 203 and/or 301 are recommended.

MATH 440 Mathematical Models (4) Construction and analysis of mathematical models and their use in investigation of physical, chemical, biological, engineering, statistical, social, and environmental problems. This analysis is conducted using calculus-based techniques and applicable computer models. W; *preq.* MATH 202

MATH 450 Complex Variables (4) Algebra of complex numbers, analytic functions, mappings, Cauchy Integral Theory, Residue theory, and applications. Sp 1995; *preq.* MATH 204

MATH 460 Real Analysis (4) Topics include set theory, real number theory, compactness, completeness, Lebesgue measure and general introduction of metric spaces. W 1994; *preq.* MATH 335

MATH 480 General Topology (4) Concepts of general topological space and metric space, compact and connected spaces, and separation axioms. Sp 1994; *preq.* MATH 335

MATH 490 Advanced Seminar in Mathematics (1-4) Discussion of advanced topics in mathematics.

MATH 495 Undergraduate Research (1-4) Independent mathematics investigation under the direction of a faculty member.

MATH 496 Senior Research Project 1 (1) The first of a two-course sequence, taken near the end of the student's bachelor program. The student's in-depth investigation of a mathematical topic culminates in the presentation of a senior paper. Su F W Sp; *preq.* department permission

MATH 497 Senior Research Project 2 (3) Continuation of MATH 496. Su F W Sp; *preq.* MATH 496

MATH 499 Special Topics in Mathematics (1-4) Individual or small-group study, under the supervision of instructor, of topics not otherwise available to students.

MGNT 310 Management Principles (4) A study of the fundamental principles of management emphasizing the managerial functions, basic concepts of systems, decision making processes, organizational theory and behavior, and its effect on management. F; *preq.* ACCT 203, ECON 101, and 102

MGNT 312 Purchasing and Materials Management (4) A complete exposition of the purchasing/materials management function in all types of profit and not-for-profit organizations. Emphasizes the purchasing decision process and the management of that activity. *Not regularly offered; preq.* MGNT 310

MGNT 320 Data Analysis (4) Computer assisted statistical analysis using SPSS or current statistical application software as a research tool. In-depth use of computer applications for research, emphasizing statistical procedures, graphic design, and interpretation of results. Applications appropriate to business, social and physical sciences, psychology, and education. Special projects to suit student's needs. W; *preq.* any one of the following courses: MATH 150, 201, 250, MGNT 355 (*Suggestion: This course should be taken before MGNT 330.*)

MGNT 330 Organizational Communication (4) A study of the communication demands and skills relevant to the student's future role as a business or professional person. Organizational communication focuses on principles and techniques involved in organizing ideas, writing effective business letters and reports, and oral communication. Applications with computer assisted statistical analysis and graphic design used to enhance business reports. F Sp; *preq.* junior standing; (*suggested preq.* MGNT 320).

MGNT 331 Business Ethics (4) Cross-listed as PHIL 331. Examination of the relationship between economic and moral constraints. *Not regularly offered.*

MGNT 332 Managerial Economics (4) Cross-listed as ECON 332. Use of economic theory and decision making techniques in business management. Production and consumer theory, applied price theory, pricing of final products, theory of profits, profit management, capital budgeting, cost and demand analysis theory to provide a solid foundation of economic understanding for use in managerial decision making. *Not regularly offered; preq.* ECON 101, 102, and MATH 201.

MGNT 335 Human Resource Management (4) Principles and practices of recruiting, selecting, training, developing, compensating, and maintaining a productive employee group through systematic human resource management planning consistent with government regulations. Includes attention to grievance and disciplinary procedures and collective bargaining. *Not regularly offered; preq.* MGNT 310

MGNT 340 International Business (4) Introduces students to international business by exploring a broad spectrum of business activities. Competitive strategy provides the unifying theme. F

MGNT 350 Organizational Behavior (4) An examination of the human problem found in organizations with emphasis on the person who is responsible for the performance of others within an organization. Topics include job satisfaction, leadership styles, people at work, basic attributes of organizations, organizational design, and job design. *Not regularly offered; preq.* MGNT 310

MGNT 355 Quantitative Methods in Business (4) A study of the quantitative tools and techniques applied to business decision-making, including decision analysis, forecasting, linear programming, quality control, inventory, and layout models. Includes the use of standardized computer programs and development of analytical models. F Sp; *preq.* MATH 201, 250, and AISM 101

MGNT 385 Production/Operations Management (4) An overview of production and operations management, including procedures and techniques generally employed in both manufacturing and non-manufacturing organizations. Topics include capacity planning, inventory systems, plant decisions, and operations decisions. Su W; *preq.* MGNT 355

MGNT 410 Business Simulation (4) Explores the analysis of business problems using computer simulations. Outcomes resulting from various inputs are projected and interpreted to aid in decision making. *Not regularly offered; preq.* MGNT 355

MGNT 480 Business and Society (4) A case-oriented course designed to study the social problems facing business organizations. Topics include culture, law, ethics, social norms, corporate and business relations, and models of human value. *Not regularly offered; preq. senior standing and business major*

MGNT 485 Business Policy and Strategy (4) A case-oriented course designed to develop skills in the integration of interdisciplinary areas as applied to problems in business. Includes both written and oral presentation of case problems. *W Sp; preq. FINA 345 and MGNT 385*

MGNT 499 Special Topics in Management (1-4) Opportunity for the junior or senior student to work on special projects under the supervision of an instructor with expertise in the area of the student's project. *Not regularly offered; preq. instructor permission; see special note on page 84.*

MLTC 111 Medical Laboratory Orientation (2) Introduction to the profession of Medical Laboratory Technology, including history, philosophy, development, educational requirements, current trends, and role and responsibilities of the medical lab technicians. Ethics, employment opportunities, certification and licensure, professional organizations, interpersonal relationships, basic medical terminology, as well as the safe handling of potentially infectious materials. *F*

MLTC 112 Basic Laboratory Skills (4) Introduction to basic laboratory procedures and techniques. Emphasis is placed on phlebotomy, microscopy, spectrophotometry, pipetting, use of centrifuges, analytical balances, bookkeeping, lab safety, and basic laboratory instruments. Laboratory mathematics, particularly in solution preparations, dilution, calculation of concentrations, and standard curve are included. *W; preq. BIOL 101 or 151, CHEM 121 or 141, and MLTC 111; 2 lec. 6 lab*

MLTC 201 Urinalysis (3) Physical, chemical, and microscopic examination of urine. Theory and applications of various laboratory tests in relation to kidney function. Brief discussion of other important body fluids. *F; preq. BIOL 162 or 310 and 320 and MLTC 112; 2 lec. 3 lab*

MLTC 202 Immunoserology (3) Introduction to basic immunology with emphasis on the principles and applications of serological techniques in diagnostic tests. *Su; Preq. BIOL 162 or BIOL 310 and 320 and MLTC 112; 2 lec. 3 lab*

MLTC 203 Blood Banking (4) Lectures and laboratory procedures in blood banking. Principles of blood grouping and human blood group genetics. Routine procedures for pretransfusion testing, antibody screening, and identification. Donor selection, blood collection, and processing are discussed. Hemolytic diseases of the newborn, preparations of blood components, and their storage and utilization are also introduced. *F; preq. MLTC 202; 2 lec. 6 lab*

MLTC 204 Parasitology (1) Introduction to medically important human parasites. Emphasis is on collection, preservation, and laboratory identification. *F; preq. BIOL 350; 1 lec. 2 lab*

MLTC 207 Clinical Microbiology (5) Diagnostic procedures for identification of medically important bacteria and fungi. Emphasis is on the morphological, cultural, biochemical, and serological characteristics of various pathogenic bacteria and fungi. *Su; co-req. BIOL 350; 3 lec. 6 lab*

MLTC 209 Hematology 1 (4) Basic laboratory methods in hematology, including cell counting, hemoglobinometry, and cell morphology. Detailed studies of blood cell maturation and development. *Sp; preq. BIOL 162 or BIOL 310 and MLTC 112; 2 lec. 6 lab*

MLTC 210 Hemostasis (2) Study of hemostatic mechanism and hemorrhagic disorders as well as their laboratory evaluations. *Sp; preq. BIOL 162 or BIOL 310 and MLTC 112; 2 lec. 2 lab*

MLTC 211 Hematology 2 (3) Continuation of MLTC 209 with emphasis on blood cell abnormalities, including anemias, leukemias, and special procedures in the study of blood diseases. *Su; preq. MLTC 209; 2 lec. 3 lab*

MLTC 212 Clinical Chemistry 1 (4) Principles, practices, and techniques of analyses of chemical components in serum, as well as other body fluids, are studied. Instrumentation associated with specific analyses is introduced. Emphasis on the specific chemical reactions and/or analytical principles, sources of error, quality control, practical applications, and theoretical aspects of the above procedures as related to normal and abnormal states. *Sp; preq. MLTC 112 and CHEM 121 and 122 or CHEM 141 and 142; 2 lec. 6 lab*

MLTC 213 Clinical Chemistry 2 (4) Continuation of MLTC 212. *F; preq. MLTC 212; 2 lec. 6 lab*

MLTC 215 Lab Simulation (3) A simulated laboratory environment is designed for students to participate in performing various tests in chemistry, hematology, urinalysis, blood banking, coagulation, and microbiology. Students are required to organize their work assignments, complete the assignments efficiently, and monitor quality control within established criteria. *W; preq. all MLTC coursework below 215; 9 lab*

MLTC 216 Medical Technology Seminar (1) Issues and trends in Medical Laboratory Technology, government regulations, professional development, employment opportunities, resume writing, and job-seeking skills are discussed. *W; preq. all MLTC coursework below 215*

MLTC 217 Case Studies (1) In conjunction with MLTC 215, students present case studies assigned in MLTC 215 to interpret and evaluate the clinical correlations and significance of the lab data. *W; preq. all MLTC coursework below 215*

MLTC 220 Clinical Practicum 1 (4) Eighteen weeks of internship providing a practical application of the skill and knowledge learned during the previous quarters of the curriculum. Students are assigned to accredited hospital laboratories as trainees. The rotation schedule consists of three weeks in hematology-coagulation, four weeks in chemistry, four weeks in microbiology, four weeks in blood banking, one week in urinalysis, and one week of elective. *W; preq. completion of all required MLTC courses with a minimum of "C" in the lab and lecture portion of each and a minimum GPA of 2.0*

MLTC 221 Clinical Practicum 2 (8) Continuation of MLTC 220. *Sp*

MLTC 225 Special Problems in Med Lab (2) Review of problems and progress during clinical practicum. Students are required to keep a daily log of the scope and degree of activities in the laboratory. The log book is filed with the department at the end of the clinical practicum. Students are also required to participate in laboratory inservice activities (and/or professional meetings if possible). Review exercises during the clinical rotation and a four-day Registry Exam review at the end of the internship are included. *Sp; preq. MLTC 220*

MLTC 226 Special Topics in Med Lab (2) Individualized study of Medical Laboratory Technology in a selected area of interest: laboratory instrumentation, lab management, quality control, laboratory computer, hematology, clinical chemistry, immunology, immunohematology, microbiology, and histology. The selected topic must be approved by the faculty member and the clinical coordinator. The student is required to do library and/or laboratory studies, and a typewritten report on the topic is submitted to the department before the end of the clinical practicum. *Sp; preq. MLTC 220*

MRKT 310 Marketing Principles (4) A study of the marketing principles, concepts, strategies, and analytical methods used by organizations to market products, services, and ideas in dynamic environments. Emphasis on identifying marketing opportunities, defining target groups, developing appropriate products, promotion distribution, and pricing strategies. *W*

MRKT 315 International Marketing (4) Directed at developing skills to make marketing decisions in a global context. This includes finding new markets, customizing products for the demands of new markets, determining needs, channels of distribution, pricing strategies, and segmentation. *Not regularly offered; preq. MRKT 310*

MRKT 320 Sales Management (4) The principles and practices of planning, organizing, motivating, and controlling the sales force. Selection, training, compensation, analysis of sales potentials, and costs are also covered. *Not regularly offered; preq. MRKT 310*

MRKT 325 Marketing Research (4) Techniques involved in the collection, tabulation, and analysis of marketing information. Includes statistical procedures and their marketing application, brand positioning, and market segmentation using marketing research techniques. Sp; preq. MRKT 310 and MATH 250

MRKT 400 Marketing Management (4) A strategic focus on marketing management with a solid application of basic marketing concepts. Concentrates in the areas of decision making, competitor analysis, formulating a marketing plan, forecasting, and planning. Not regularly offered; preq. MRKT 310

MRKT 499 Special Topics in Marketing (1-4) Opportunity for the junior or senior student to work on special projects under the supervision of an instructor with expertise in the area of the student's project. Not regularly offered; preq. MRKT 310 and instructor permission; see special note on page 84.

MUSI 100 Introduction to Music Theory (3) Developmental theory course used to make up deficiency. Introduction to staff, pitch, rhythmic notations, chords, ear training. F

MUSI 101 Music Theory 1 (3) Melodic, harmonic, and rhythmic principles of music and notation. F; preq. theory placement exam

MUSI 102 Music Theory 2 (3) Continuation of MUSI 101. W; preq. MUSI 101

MUSI 103 Music Theory 3 (3) Continuation of MUSI 102. Sp; preq. MUSI 102

MUSI 120 Introduction to Music Literature (3) Development of listening skills for understanding elements of musical style in historical perspective and significance of music as a fine art. F W Sp

MUSI 121 Introduction to Baroque Music (3) Study of selected works from Baroque style periods through readings, tapes, recordings, and other media. Offered on demand; preq. MUSI 120 or permission; non-humanities majors

MUSI 122 Introduction to Music of the Classical and Romantic Periods (3) Study of selected works from the Classical and Romantic style periods through readings, tapes, recordings, and other media. Offered on demand; preq. MUSI 120 or permission; non-humanities majors

MUSI 123 Introduction to 20th Century Music (3) Study of selected works of 20th Century, both traditional and electronic, through readings, scores, tapes, recordings, and other media. Offered on demand; preq. MUSI 120 or permission; non-humanities majors

MUSI 160 Fundamentals of Music (3) Principles of notation, meter, major, and minor scales, rhythmic and melodic reading, singing, and keyboard. F W Sp

MUSI 161 Music for the Classroom Teacher (3) Methods of teaching elementary music with emphasis on singing, playing instruments, and rhythmic body movements. F W Sp; preq. MUSI 160 and EDUC 110

MUSI 170 Class Voice (1) Basic techniques of voice production: breathing, diction, projection, tone-color, and interpretation. Repeatable for credit—maximum of six quarters. F W Sp; preq. music reading must be taken in sequence or by permission

MUSI 180 College Chorus (2) Repeatable for credit—maximum of three quarters. F W Sp; preq. permission of instructor (audition); 4 lab

MUSI 181 College Band (2) Repeatable for credit—maximum of three quarters. F W; preq. permission of instructor (audition); 4 lab

MUSI 185 Vocal Ensemble (2) Repeatable for credit—maximum of six quarters. F W Sp; preq. permission of instructor (audition); 4 lab

MUSI 186 Instrumental Ensemble (2) Repeatable for credit—maximum of six quarters. F W; preq. permission of instructor (audition); 4 lab

MUSI 190 Piano Class 1 (1) Study of scales and finger techniques for beginning players. F W Sp

MUSI 191 Piano Class 2 (1) Continuation of MUSI 190. F W Sp

- MUSI 192 Piano Class 3 (1)** Continuation of MUSI 191. F W Sp
- MUSI 220 Music Literature (3)** Survey of musical forms, styles, and performance media from Gregorian to present. Humanities majors. F W Sp
- MUSI 221 Music History and Literature 1 (3)** Study of literature and musical styles to 1600. *Offered on demand; req. MUSI 220 or permission*
- MUSI 222 Music History and Literature 2 (3)** Study of literature and musical styles 1600-1850. *Offered on demand; req. MUSI 221 or permission*
- MUSI 223 Music History and Literature 3 (3)** Study of literature and musical styles 1850 to present. *Offered on demand; req. MUSI 222 or permission*
- MUSI 225 Appalachian Music History 1 (4)** Understanding of the history of Appalachian music and the people, locations, and stories that underlie the music. Examines the evolution and influences of Appalachian music.
- MUSI 226 Appalachian Music History 2 (4)** Continuation and expansion of MUSI 225, including study of ballads, children's songs, dance, and musical families.
- MUSI 230 Music-Theater (3)** Participation through production or performance of selected musical theater projects. *Su Sp*
- MUSI 270 Intermediate Class Voice (1)** Continuation of MUSI 170 series. Repeatable for credit—maximum of six quarters. F W Sp; *req. permission of instructor*
- MUSI 280 Intermediate Chorus (2)** Continuation of MUSI 180 series. Repeatable for credit—maximum of three quarters. F W Sp; *req. permission of instructor*
- MUSI 299 Topics in Music (1-4)** Study of various music topics not otherwise available to students: folk and country, rock forum. Repeatable for credit—maximum of three quarters. *Offered on demand*
- MUSI 361 Teaching Music in Elementary Grades (3)** Materials and methods for teaching elementary vocal music. *Offered on demand; req. MUSI 103*
- MUSI 370 Applied Voice (1)** Repeatable for credit—maximum of six quarters. F W Sp; *req. music concentration; permission of instructor*
- MUSI 371 Applied Piano (1)** Repeatable for credit—maximum of six quarters. F W Sp; *req. music concentration; permission of instructor*
- MUSI 372 Applied Organ (1)** Repeatable for credit—maximum of six quarters. F W Sp; *req. music concentration; permission of instructor*
- MUSI 373 Applied Woodwind (1)** Repeatable for credit—maximum of six quarters. *Offered on demand; req. music concentration; permission of instructor*
- MUSI 374 Applied Brass (1)** Repeatable for credit—maximum of six quarters. *Offered on demand; req. music concentration; permission of instructor*
- MUSI 390 Conducting (3)** Conducting basic beat patterns; conducting techniques for choral groups; style and interpretation. *Offered on demand; req. music concentration or permission*
- NTSC 240 Introduction to Environmental Science (4)** Cross-listed as CHEM 240. Survey of the nature and scope of environmental problems. Emphasis on the physical, biological, and human aspects of environmental science. *Sp; req. sophomore standing with coursework in the basic sciences, BIOL 151, CHEM 143, or GEOL 201; 3 lec. 2 lab*
- NTSC 485S Community Involvement (Core Course) (2)** Community Involvement is an outgrowth of the purposes and objectives of the University. The series of activities integral to the Community Involvement course enhance the education of the student, complement the senior seminar, and promote reflection on the student's obligation to human beings in need and society at large. *(not offered summer quarter)*

NTSC 490S Senior Seminar (Core Course) (4) This course provides an opportunity for students to place their chosen field of study in an interdisciplinary context with intellectual, ethical, and historical perspectives. The seminar focuses on the synthesis and integration of various concepts by applying them to the analysis and solution of problems chosen in the context of their academic disciplines. Oral and written presentations of the seminar paper are required. *F W Sp; preq. senior standing and 44 core hours*

OADM 101 Keyboarding 1 (3) A study of the touch system of keyboarding with emphasis on development of speed and accuracy on the microcomputer. Touch system on the ten-key numeric keypad on the microcomputer is included. *Su F W Sp; 3 lec. 1 lab*

OADM 102 Keyboarding 2 (3) Continuation of OADM 101 with application of basic keyboarding techniques to the production of letters, memorandums, outlines, tabulated reports, and manuscripts on the microcomputer. *W; preq. OADM 101; 3 lec. 1 lab*

OADM 103 Keyboarding 3 (3) Continuation of OADM 102 with emphasis on developing the ability to produce mailable copy of technical reports, drafts, and business correspondence. *Sp; preq. OADM 102; 3 lec. 1 lab*

OADM 111 SuperWrite 1 (3) Introduction to reading and writing of SuperWrite, an alphabetical writing system, and the development of transcription skills which include vocabulary development, spelling, punctuation, and grammar. *W; 3 lec. 1 lab*

OADM 112 SuperWrite 2 (3) Continuation of OADM 111 designed to perfect SuperWrite theory, phonetics, word families, abbreviations, and penmanship. Students are encouraged to raise speed and accuracy levels. *Sp; preq. OADM 111; 3 lec. 1 lab*

OADM 130 Records Management (3) Designed to emphasize the principles and practices of effective records management for manual and automated records systems. The ARMA alphabetic indexing rules are applied. *F; 3 lec. 1 lab*

OADM 140 Machine Transcription (3) A course designed to develop the ability to transcribe business documents into mailable copy form using transcription equipment and microcomputers. Emphasis is placed on proofreading skills, correct grammar usage, and use of correct punctuation. *Sp; preq. OADM 102 and 221; 3 lec. 1 lab*

OADM 214 Microcomputer Office Practice (3) An advanced keyboarding simulation allowing students to use the skills attained in keyboarding and word processing classes to work in various departments of a simulated company as a keyboarding specialist. *F; preq. OADM 103 and 222; 3 lec. 1 lab*

OADM 215 Lotus 1-2-3 (3) An introduction to Lotus 1-2-3. *W; preq. keyboarding skills and basic knowledge of microcomputers; 3 lec. 1 lab*

OADM 216 MS Word For Windows (3) An introduction to the MS Word For Windows word processing system. *Sp; preq. keyboarding skills; 3 lec. 1 lab*

OADM 221 Word Processing 1 (3) Word processing concepts and skills are presented to the person with no previous training in word processing. WordPerfect 5.1 software is used. *W; preq. keyboarding skills; 3 lec. 1 lab*

OADM 222 Word Processing 2 (3) Continuation of OADM 221 with more advanced applications of the WordPerfect 5.1 software. *Sp; preq. OADM 221; 3 lec. 1 lab*

OADM 240 Desktop Publishing (3) An introduction to the PageMaker 4.0 desktop publishing software program. *F; preq. basic knowledge of microcomputers; 3 lec. 1 lab*

OADM 241 Office Administration 1 (3) Introduction to the responsibilities and opportunities of an office administration position encompassing a variety of secretarial duties. Lab work is completed on a microcomputer. *F; preq. OADM 103, 140, and 222; coreq. OADM 214; 3 lec. 1 lab*

OADM 242 Office Administration 2 (3) A continuation of OADM 241, including assisting with travel arrangements, planning meetings, presenting business data, and handling financial procedures. *W; preq. OADM 222, and 241; 3 lec. 1 lab*

OADM 243 Office Administration 3 (3) An executive secretarial simulation allowing students to work in a fictitious company using the executive and administrative skills they have attained in their office administration classes. *Sp; preq. OADM 140, 222, and 242; 3 lec. 1 lab*

OADM 244 Medical/Legal Office Administration (3) Introduction to the proper procedures for preparing medical reports, clinical reports, general medical documents, and various types of legal documents using a microcomputer. An extensive list of medical and legal terms and their correct usage in documents is emphasized. *W; preq. OADM 140, 222, and 241; 3 lec. 1 lab*

OADM 299 Special Topics in Office Administration (1-4) Opportunity for the student to work on special projects under the supervision of an instructor with expertise in the area of the student's project. *Not regularly offered; preq. instructor permission; see special note on page 84.*

OTAT 101 Introduction to Occupational Therapy (4) Introduction to the profession of occupational therapy, the roles and functions of occupational therapy personnel, the areas of occupational performance, and the theoretical basis of using goal-directed activities. *W; preq. enrollment in OTA program*

OTAT 102 Therapeutic Media 1 (3) Introduction to the analysis and therapeutic application of activities. Includes skill development in selected activities, instruction of peers in an activity, and participation in proper care and maintenance of equipment and supplies. *W; preq. enrollment in OTA program*

OTAT 103 Disease Pathology (4) Discussion of both physical and psychosocial dysfunctions commonly referred to occupational therapy. Includes the symptoms, etiology, and treatments of various diseases. *Sp; preq. OTAT 101, BIOL 101, and AHNHR 102*

OTAT 108 Practicum 1 (2) Supervised clinical experience under the direction of qualified personnel in a variety of settings. Emphasis is on developing professional communication skills, learning to accurately document observations, developing an understanding of other health care professionals, and instructing a small group in an activity. See academic requirements of OTA program. *W; preq. enrollment in OTA program*

OTAT 109 Applied Anatomy and Kinesiology (2) Study and application of human anatomy and basic movement principles as used in occupational therapy. *Sp; preq. OTAT 103*

OTAT 110 Group Dynamics (2) Study of group behavior. Practice in leading groups, observing group interactions, and participating in various types of groups. *Sp; preq. OTAT 103, PSYC 101, and SOCI 101*

OTAT 203 Occupational Therapy Assistant in Developmental Disabilities (6) Study of conditions which interfere with normal growth and development. Introduction to the application of occupational therapy in the treatment of developmental disabilities. Emphasis on the role of the O.T. assistant in treatment of developmental disabilities particularly in the public school setting. *F; preq. OTAT 108, 109, 110, PSYC 101, and 151*

OTAT 204 Practicum 2 (3) Similar to OTAT 108 but in different types of settings. *Su; preq. OTAT 108, 109, and 110*

OTAT 205 Therapeutic Media 2 (3) Analysis, adaptation, and therapeutic application of activities not covered in OTAT 102. *Su; preq. OTAT 101*

OTAT 206 Contemporary Media in Occupational Therapy (2) Analysis, adaptation, and therapeutic applications of "high-tech" media. Emphasis on computer adaptations, construction of switches, and use of video in patient treatment. *F; preq. Completion of or concurrent with OTAT 102*

OTAT 208 Practicum 3 (3) Supervised clinical experience under the direction of qualified personnel in a variety of settings. Continuation of skill development of OTAT 204 with additional emphasis on case study, treatment planning, and occupational therapy treatment techniques. *F; preq. OTAT 204*

OTAT 209 Occupational Therapy Assistant in Geriatric Program Planning (4) Introduction to and application of occupational therapy in the treatment of older adults. Emphasis is on developing and implementing both activity and rehabilitative programs in agencies serving the elderly. *W; preq. OTAT 210*

OTAT 210 Occupational Therapy Assistant in Physical Disabilities (5) Exploration of occupational therapy theories in the evaluation and treatment of physically disabling conditions. Lab emphasis on instruction of activities of daily living, work simplification, energy conservation, and fabrication of orthotic and adaptive devices. *Su; preq. OTAT 204*

OTAT 211 OTA Seminar (2) Discussion of the professional roles and responsibilities of the occupational therapy assistant. Includes orientation to licensure, certification, legal and ethical issues, peer review, and other current professional issues. *W; preq. OTAT 208 and 210*

OTAT 212 Occupational Therapy Assistant in Mental Health (4) Exploration of occupational therapy theories in the evaluation and treatment of psychosocial dysfunction. Lab emphasis on the development of observation skills, group dynamics, group leadership, effective communication, and therapeutic use of self. *W; preq. OTAT 208, 210, PSYC 101, 151, and SOCI 101*

OTAT 220-221 Clinical Application (6 ea.) Supervised fieldwork placement. Experience in and responsibility for delivery of service to patients/clients. Emphasizes the application of academically acquired knowledge leading to the performance of an entry-level occupational therapy assistant. See academic and clinical requirements of OTA program. *Sp; preq. successful completion of all OTA and other required courses*

OTAT 299 Special Topics in OT (1-3) Provides students an opportunity to gain additional knowledge or experience in a specific area of occupational therapy. *Su F W Sp; preq. admission to OTA program and permission of instructor*

OTST 305 Disease Pathology 2¹ (4) The etiology, clinical course, management, and prognosis of congenital, developmental, acute, and chronic disease processes and traumatic injuries. The effect of such conditions on human functioning throughout the life span. Focus is on neuromuscular, musculoskeletal, and neurological systems. *F; preq. admission to OT program or OTAT 103*

OTST 310 Practicum 1 for OTS¹ (2) Level 1 Fieldwork. The first competency based fieldwork course to develop professional skills in health service delivery. Students gain an appreciation of the role of occupational therapy in health care. Students are assigned to a variety of agencies serving health care needs. *Sp; preq. admission to OT program and OTAT 101*

OTST 330 Orthotics¹ (3) Includes theoretical basis and application of orthotics to enhance independent daily living performance in work, play/leisure, and self care. Designing, fabricating, and using orthotic devices. *W; preq. admission to OT program and OTAT 206*

OTST 410 OT in Physical Disabilities 1¹ (4) Theories, approaches, and principles of occupational therapy programming for physical function throughout the life span. Includes theoretical basis, assessment, and treatment to foster age-appropriate skills in daily living activities, work, and play/leisure. Emphasis is on theory and assessment. *W; preq. OTST 305, BIOL 311, and PHYS 201*

OTST 411 OT in Physical Disabilities 2¹ (4) Continuation of theory application covered in OTST 410, with emphasis on treatment planning, adaptations, prevention, health maintenance, and remediation. *Sp; preq. OTST 410 and BIOL 314*

OTST 412 OT in Mental Health 1¹ (4) Theories, approaches, and principles of occupational therapy programming for mental health services throughout the life span. Includes theoretical basis, assessment, and treatment to foster age-appropriate skills in daily living activities, work, and play/leisure. Emphasis is on theory and assessment. *W; preq. OTST 305 and PSYC 400*

¹ Pending approval by the Ohio Board of Regents.

OTST 413 OT in Mental Health 2¹ (4) Continuation of theory application covered in OTST 412, with emphasis on treatment planning, adaptation, prevention, health maintenance, and remediation. *Sp; preq. OTST 412 and BIOL 314*

OTST 416 OT in Gerontology¹ (4) Theories, approaches, and principles of gerontic occupational therapy. Theories of aging, normal physiological and psychological changes of aging, specific diseases and conditions, and common problems of the aging population. Includes quality assurance, consultative role of the OTR in nursing homes, and legal issues regarding aging. *Sp; preq. OTST 410 and 412 and BIOL 314*

OTST 420 Practicum 2 for OTS¹ (2) Level 1 Fieldwork. The second competency based fieldwork to develop professional skills in occupational therapy service delivery. Focus on observation, evaluation, and documentation of client abilities. Students are assigned to agencies different from those in OTST 310. *Sp; preq. OTST 410 and 412*

OTST 421 Practicum 3 for OTS¹ (2) Level 1 Fieldwork. The third competency based fieldwork to develop professional skills in occupational therapy service delivery. Focus on treatment planning and implementation. Students are assigned to agencies different from those in OTST 310 and OTST 420. *Su; preq. OTST 420*

OTST 430 OT in Developmental Disabilities 1¹ (5) Theories, approaches, and principles of occupational therapy programming for issues related to normal and abnormal patterns of human development. Evaluation, program planning, and treatment application as it pertains to individuals and their families. *Su; preq. OTST 411 and 413, BIOL 314, and PSYC 151*

OTST 431 OT in Developmental Disabilities 2¹ (4) Continuation of material covered in OTST 430, with emphasis on neurodevelopmental and sensory integration theory and treatment. *F; preq. OTST 430*

OTST 450 Research Designs and Methods in OT¹ (4) Students learn to be consumers of research data, conduct literature searches, examine methods of research design and data collection, and prepare a research proposal related to occupational therapy. *F; preq. OTST 411, 413, 416, 430, and MATH 150*

OTST 451 Occupational Therapy Management and Program Planning¹ (4) Occupational therapy service management skills. Includes health care trends, quality assurance, and legal issues. Students develop a model for the delivery of occupational therapy services in a selected agency or facility. *F; preq. OTST 430 and CISB 101*

OTST 495 Clinical Application 1¹ (12) Level 2 Fieldwork. Three months of supervised, in-depth field experience in a selected practice area of occupational therapy. Student is supervised by a Registered Occupational Therapist. *W; preq. successful completion of all required courses in OT curriculum.*

OTST 496 Clinical Application 2¹ (12) Level 2 Fieldwork. Three months of supervised, in-depth field experience in a practice area different from OTST 495. Student is supervised by a Registered Occupational Therapist. *Sp; preq. OTST 495*

OTST 497 Clinical Application 3¹ (Optional) (4, 8, or 12) Level 2 Fieldwork. One to three months of supervised, in-depth field experience in a specialty practice area of occupational therapy. Student is supervised by a Registered Occupational Therapist. *Su; preq. OTST 496*

PHIL 100 Introduction to Philosophy (4) An introduction to the varieties of philosophy through selected primary texts from ancient Greece through the present. Presents basic problems, concepts, and methods. *Su*

PHIL 103 Introduction to Ethics (4) Classic and modern philosophical views of the nature of morality. Recognizing the moral dimension of a choice and reasoning about alternatives. *Offered on demand*

¹ Pending approval by the Ohio Board of Regents.

- PHIL 105 Rhetoric and Reasoning (4)** The use and abuse of language in everyday life, especially in advertising, politics, and education. *Offered on demand*
- PHIL 170 Introduction to Formal Logic (4)** Deductive and inductive reasoning; translation from natural to formal language; sentential logic, Aristotelian logic, predicate logic; logic and computers. *Offered on demand*
- PHIL 280 The Judeo-Christian Tradition (4)** How our culture is informed by this tradition. Application to selected contemporary issues. *Offered on demand*
- PHIL 285 Oriental Philosophy (4)** The spiritual traditions of Hinduism, Buddhism, Confucianism, and Taoism. *Offered on demand*
- PHIL 300 Philosophy in Film (4)** Viewing and discussion of international films to raise moral, aesthetic, and ethical issues. *W*
- PHIL 316 Existentialism (4)** The unique individual vs. the crowd; total freedom and unlimited responsibility; creating the self vs. bad faith; the solitary individual before God or the superman who can face the death of God. Primary readings from Kierkegaard and Nietzsche. *Offered on demand*
- PHIL 320S Ethics in Public and Private Life (4)** Personal, familial, social, and professional value decisions: how to recognize and make them. *F W Sp*
- PHIL 331 Business Ethics (4)** Cross-listed as BAMN 331. Examination of the relationship between economic and moral constraints. *F*
- PHIL 332 Biomedical Ethics (4)** Ethical issues in medicine, medical research, and biotechnology: medical models of treatment, relations within the health team, physician-patient relations, death and dying, wellness and illness, informed consent, refusal of treatment; right to health care, experimental treatment, bioengineering of plants, animals, and humans. *W*
- PHIL 333 Philosophy and Technology (4)** Social and political implications of contemporary information processing, bioengineering, surveillance, and warfare. Rights and responsibilities of technological experts. *Offered on demand*
- PHIL 334 Environmental Ethics (4)** Theories of the environment; alternative views of our responsibility for the environment; environmental vs. economic values; methods of deciding environmental questions. *Sp*
- PHIL 335 Philosophy and Education (4)** Theories of teaching and learning from ancient Greece to the contemporary classroom. *Offered on demand*
- PHIL 430 Capitalism, Socialism, and Democracy (4)** Rights and justice in business; alternative theories of economics; leadership vs. participation. *Sp*
- PHYS 099 Fundamental Physics (4)** A course intended for special programs and not considered a prerequisite for the college entry-level physics courses. Students desiring a basic course in physics should refer to PHYS 201. *Offered on demand.*
- PHYS 201 Physics 1 (Mechanics) (4)** Newton's Laws of Motion. Other appropriate topics may be included. Laboratory and demonstrations related to lecture. *F W; preq. MATH 130 or equivalent; 3 lec. 3 lab*
- PHYS 202 Physics 2 (Electricity and Magnetism) (4)** Basic properties of electric and magnetic fields. Other appropriate topics may be included. Laboratory and demonstrations related to lecture. *Sp; preq. PHYS 201; 3 lec. 3 lab*
- PHYS 203 Physics 3 (Energy) (4)** First and second laws of thermodynamics. Other appropriate topics may be included. Laboratory and demonstrations related to lecture. *W Sp; preq. PHYS 201; 3 lec. 3 lab*
- PHYS 210 Astronomy (4)** Fundamental ideas of astronomy. Topics include the solar system, stars, galaxies, black holes, and the history of ideas about the universe. *Sp; preq. PSCI 110S; 3 lec. 3 lab*

- PHYS 211 Calculus-Based Physics 1 (4)** Introductory survey of mechanics for science and engineering students. Introduces the use of calculus in interpreting physical phenomena. Topics include vectors, kinematics, and Newton's theory of motion. *Preq. or coreq. MATH 201*
- PHYS 212 Calculus-Based Physics 2 (4)** Introductory survey of thermodynamics for science and engineering students. Introduces the use of calculus in interpreting physical phenomena. Topics include the first and second laws of thermodynamics. *Preq. PHYS 211 or instructor permission; preq. or coreq. MATH 202*
- PHYS 213 Calculus-Based Physics 3 (4)** Introductory survey of electricity and magnetism for science and engineering students. Introduces the use of calculus in interpreting physical phenomena. Topics include some of Maxwell's equations. *Preq. MATH 202 and PHYS 212 or instructor permission*
- PHYS 290 Seminar in Physics (1-4)** Discussion of advanced topics in physics.
- PHYS 295 Independent Study (1-4)** Independent physics investigation under the direction of a faculty member.
- PHYS 299 Special Topics in Physics (1-4)** Individual or small-group study, under the supervision of instructor, of topics not otherwise available to students.
- PHYS 390 Seminar in Physics (1-4)** Discussion of advanced topics in physics.
- PHYS 485 Senior Project (1-4)** In-depth study of a selected topic in physics culminating in the preparation of a senior paper. *Preq. junior or senior standing*
- PHYS 490 Seminar in Physics (1-4)** Discussion of advanced topics in physics. *Preq. junior or senior standing*
- PHYS 495 Undergraduate Research (1-4)** Independent physics investigation under the direction of a faculty member. *Preq. junior or senior standing*
- PHYS 499 Special Topics in Physics (1-4)** Individual or small-group study, under the supervision of instructor, of topics not otherwise available to students. *Preq. junior or senior standing*
- PSCI 101 Physical World (4)** Designed for non-science majors. Fundamental topics in meteorology include atmosphere, winds, clouds, storms, and weather. Topics in geology include rocks and minerals, gradation, earthquakes, continental drift, and the ocean. *3 lec. 3 lab*
- PSCI 105 Physical Science (5)** A course designed for students of nursing and other health technologies, stressing the principles of physics and chemistry relevant to the health sciences. Credit earned may be applied toward degrees only in the School of Allied Health and Nursing. *Preq. MATH 101 or placement MATH 105; 3 lec. 3 lab*
- PSCI 110S Physical Science Core Course (4)** Explores the depth and breadth of the physical sciences. Science is presented as a human activity that helps us perceive order in our surroundings, making our world understandable. The relationship between science, society, and current issues is examined. *F W Sp*
- PSCI 251 Physical Science by Inquiry 1 (4)** An inquiry-based (lab-oriented) course in the physical sciences designed primarily for those students who expect to teach the physical sciences (K-12) or those who learn better with a hands-on approach to science. Topics include properties of matter (mass, volume, density, concentration, and solubility) and heat and temperature (calorimetry, phase change, and heat transfer). *6 lab*
- PSCI 252 Physical Science by Inquiry 2 (4)** A continuation of PSCI 251. Topics include electric circuits (current, voltage, power, energy, d.c. circuits) and light and optics (refraction, reflection, image formation, and color). *6 lab*
- PSCI 295 Independent Study (1-4)** Independent physical science investigation under the direction of a faculty member.

PSCI 299 Topics in Physical Science (1-4) Individual or small-group study, under the supervision of instructor, of topics not otherwise available to students.

PSYC 098 Learning Orientation (4) Techniques for learning definitions, vocabulary, lists, etc. to assist in academic achievement. (The four hours of credit do not apply toward a degree but do apply toward total hours accumulated at the University.)

PSYC 101 Introduction to Psychology (4) A study of the individual in terms of maturational, learning, thinking, emotional, motivational, sensory, and perceptual processes. Required course for all social science majors.

PSYC 105 Career Planning (4) This course helps students explore their values, interests, and skills in relation to careers and choosing a college major. Special emphasis on career counseling. Career exploration on the computer is available.

PSYC 150 Principles of Statistics (4) Cross-listed as MATH 150 and SOCI 150. Introduction to the vocabulary, concepts, formulas, and presentation of statistics as applied to business, education, and science. Topics include measures of central tendency and dispersion, probability applied to joint probability tables and Bayes' Theorem, probability distributions with emphasis on Binomial and Normal, sampling practices and theory, and calculator and computer use. *Preq.* MATH 101

PSYC 151 Human Growth and Development (4) Study of the factors affecting human growth and development through the life cycle from infancy to advanced maturity. *Preq.* PSYC 101

PSYC 199 Special Topics in Psychology (1-4) Individual or small-group study, under the supervision of instructor, of topics not otherwise available to students. Separate courses repeatable for credit

PSYC 260 Neurobiology of Behavior (4) Cross-listed as BIOL 260. Basic neurology, neurophysiology, and neuropharmacology, with emphasis on how they relate to human behavior. *Preq.* BIOL 110S and PSYC 101

PSYC 273 Psychology of Human Adjustment (4) An examination of the individual's adjustments and conflicts in modern society. Considers problem-solving strategies and anxiety reducing behavior. Required course for all social science majors. *Preq.* PSYC 101

PSYC 290 Psychological Tests and Measurements (4) Study of the nature, construction, and use of tests and measurements in education, industry, and government, including aptitude, ability, and achievement tests; attitude and rating scales; and opinion surveys. *Preq.* PSYC 101

PSYC 299 Special Topics in Psychology (1-4) Courses repeatable for credit. *Preq.* PSYC 101 and/or permission

PSYC 300 Theories of Personality (4) Understanding of human personality through examination of psychoanalytic, humanistic, and learning theories and current biologically-based research on personality. *W; preq.* PSYC 101

PSYC 303 Introduction to Social Psychology (4) Cross-listed as SOCI 303. Behavior of the individual as influenced by other individuals, social groups, and culture. Examines group dynamics, leadership, attitude, and group conflict. *Preq.* PSYC 101

PSYC 304 Psychology of Learning (4) Study of learning: classical and instrumental conditioning, discrimination, generalization, verbal, information processing, memory, problem solving, and concept formation. *F; preq.* PSYC 101

PSYC 310 Child Psychology (4) A survey of the course of development during the first 12 years of life, with emphasis on patterns of physical, cognitive, and mental development; parent/child relations; and the influences of TV and divorce on children. *F Sp; preq.* PSYC 101

- PSYC 311 Human Sexuality (4)** Cross-listed as SOCI 311. An in-depth view of the current status of human sexuality in the U.S. Examines current research; modes of sexual expression and enhancement; physiological, sociological, and psychological basis of human sexuality; sexual variations; and sex ethics.
- PSYC 312 Adolescent Psychology (4)** Study of major theories of adolescent development and explanation of biological, cognitive, social, emotional, and personality processes. Focus is on recent trends and changes in family relationships, adolescent autonomy, educational and vocational roles, moral development and religion, teenage creativity, depression, substance abuse, eating disorders, runaways, suicide, pregnancy, and parenthood. *Sp; preq. PSYC 101*
- PSYC 316 Behavior Problems in Children (4)** Analysis of personal and school-related problems of children. Cases of behavior problems with specific intervention techniques. *Sp; preq. PSYC 101*
- PSYC 340 Psychology of the Adult (4)** Theoretical study of adulthood with an emphasis on the applications of psychological research for a better understanding of later life. Class presentations and discussions cover age-related changes in physical, cognitive, social, and personality development and address issues in adult psychopathology, death, and dying. *Preq. PSYC 101*
- PSYC 360 Drugs/Substance Abuse (4)** Cross-listed as HPER 360 and SOCI 360. An in-depth study of alcohol, tobacco, and other drugs and how chemical dependency on these drugs can affect individual performance and behavior.
- PSYC 361 Industrial Psychology (4)** Applies social/psychological approach to individual's work behavior. Topics include management approaches to organizational processes resulting in productivity and satisfaction, change, turbulent environment, and psychologist's role. *Preq. PSYC 101 or SOCI 101*
- PSYC 375 Educational Psychology (4)** Psychological foundations of education with emphasis on learning, transfer, motivation, and evaluation. *F W Sp; preq. PSYC 101*
- PSYC 380 Psychology of Exceptional Children and Youth (4)** Psychological study of exceptionality, including the physically, socially, and emotionally handicapped, and the intellectually handicapped and gifted. The psychological characteristics of the exceptional children and youth are investigated, and current programs used to help them are identified and evaluated. *Preq. 12 credit hours of PSYC and/or instructor permission*
- PSYC 399 Special Topics in Psychology (1-4)** Individual or small-group study, under the supervision of instructor, of topics not otherwise available to students.
- PSYC 400 Abnormal Psychology (4)** Study of anxiety, mood, psychotic, personality, and psychoactive substance use disorders as well as substance-induced organic mental disorders. Several theories and strategies of psychotherapy are examined during discussion of each disorder. *F W Sp; preq. at least 12 credit hours of PSYC*
- PSYC 405 Death and Dying (4)** Cross-listed as SOCI 405. Focus on increased ability to deal with one's own mortality; skills for working with terminally ill and their families; understanding the complex social system of death in American society; and moral, ethical, and philosophical issues surrounding death. *Preq. PSYC 101 or SOCI 101*
- PSYC 410 Psychology of Counseling (4)** Survey of the basic concepts and theories of counseling: psychodynamic, behavioral, cognitive, and humanistic. Focus is on individual and group counseling, including school, career, family and marriage, mental health, cross-cultural, crisis intervention, and consultation. *Sp; preq. 20 credit hours of PSYC and/or instructor permission*
- PSYC 420 Community Psychology (4)** Analysis of historical precedents, epidemiology, community resources, primary prevention programs, and the role of psychologists as agents of social change. *Preq. PSYC 101*

PSYC 440 Environmental Psychology (4) Psychological investigation of the relationship between individual behavior and physical environment with analysis of the impact of crowding, noise, temperature, lighting, pollution, and architecture on individual behavior. *Preq.* 16 credit hours of PSYC and/or instructor permission

PSYC 475 Psychological Study of Contemporary Problems (4) In-depth analysis of current issues, problems, and controversies in psychology. *Preq.* 24 credit hours of PSYC (senior students in psychology)

PSYC 499 Special Topics in Psychology (1-4) Individual or small-group study, under the supervision of instructor, of topics not otherwise available to students. *Preq.* senior standing and permission

PTAT 111 Principles of Physical Therapist Assistant (3) The purpose, philosophy, history, and development of the physical therapy profession. Includes medical ethics, the function of the American Physical Therapy Association, and the development of the physical therapist assistant (duties, function, legal responsibilities, and limitations). *Preq.* admission to PTA program

PTAT 112 Physical Therapist Assistant Procedures 1 (5) The first of three sequential procedure courses. Basic physiology and theory of heat, hydrotherapy, cold, massage, body mechanics, burns, patient positioning, and traction. Therapeutic application of these modalities. *Preq.* AHN 102 and PTAT 111; 3 lec. 6 lab

PTAT 113 Physical Therapist Assistant Procedures 2 (5) Theory and therapeutic application of modalities, such as low and high frequency currents, biofeedback, TENS, Jobst extremity pump, and diathermy. *Preq.* PTAT 112; 3 lec. 6 lab

PTAT 114 Anatomy and Kinesiology (5) Advanced anatomy course designed specifically for the physical therapist assistant. Origin, insertion, function, and dysfunction. *Preq.* PTAT 113 and BIOL 311; 3 lec. 6 lab

PTAT 115 P.T. in Physical Dysfunction (3) Discussion of physical dysfunctions commonly referred to physical therapy. Includes symptoms, etiology, and treatments of various diseases. *Preq.* PTAT 111; 3 lec.

PTAT 202 Physical Therapist Assistant Procedures 3 (5) Theory and application of principles of muscle testing and goniometry. Includes study and use of rehabilitation skills relating to prosthetics, orthotics, postural deviations, cardiac conditions, and pre and post partum condition. *Preq.* PTAT 113; 3 lec. 6 lab

PTAT 212 Clinical Practicum 1 (4) Second experience in clinical setting in which the student performs theories and techniques for patient care under close supervision of a licensed physical therapist. *Preq.* PTAT 114, 115, and 216; 2 lec. 12 clinical

PTAT 213 Clinical Practicum 2 (4) Intermediate experience in clinical settings performing previously learned theories and techniques under supervision of a licensed physical therapist. *Preq.* PTAT 202, 212, and 231; 2 lec. 12 clinical

PTAT 214 Clinical Practicum 3 (6) Advanced experience in clinical setting. *Preq.* PTAT 213, 232, and 255; 38 clinical

PTAT 216 Clinical Practicum Seminar (2) Introductory experience in clinical setting. Students perform theories and techniques of patient care under close supervision of licensed physical therapist. Procedures and techniques discussed in seminar. *Preq.* PTAT 111 and 112; 1 lec. 4 clinical

PTAT 231 Rehabilitation Procedures 1 (4) The first of two sequential, therapeutic, exercise classes. Exercises for specific joints and orthopedic conditions. Includes joint range of motion, flexibility, coordination, and gait training. *Preq.* PTAT 113; 3 lec. 3 lab

PTAT 232 Rehabilitation Procedures 2 (4) Rehabilitation skills needed for treatment of central nervous, peripheral nervous, and respiratory systems. Included are stroke rehabilitation, spinal cord injuries, pediatrics, and postural drainage. *Preq.* PTAT 231; 3 lec. 3 lab

- PTAT 235 Physical Therapy Trends and Administrative Procedures (2)** Identification of concepts, techniques, and administrative skills used in the efficient operation of physical therapy department. Special emphasis on establishing and maintaining patient records. *Preq.* PTAT 212
- PTAT 255 PTA Seminar (2)** Students present case studies of patients treated in their clinical assignments. Special procedures, techniques, and problems encountered are discussed. *Coreq.* PTAT 214
- RDLT 101 Radiologic Technology 1 (4)** A course designed to acquaint the student with the goals, philosophies, and organizations of the radiography program and the radiology department. Medical ethics, medicolegal considerations, elementary radiation protection, fundamentals of radiographic exposure, and radiographic positioning of the chest and abdomen are covered. *F; preq. admission to radiologic technology program*
- RDLT 102 Radiologic Technology 2 (4)** Concentration on radiographic positioning of the appendicular skeleton with application of theory in the laboratory. Selected clinical experiences reinforce learning and provide the opportunity to apply principles and techniques. *W; preq. RDLT 101*
- RDLT 103 Radiologic Technology 3 (3)** Concentration on radiographic positioning of the axial skeleton with application of theory in the laboratory. *Sp; preq. RDLT 102*
- RDLT 104 Radiologic Technology 4 (3)** Concentration on radiographic procedures using contrast media, radiographic practices for surgery, pediatric radiography, and other specialized areas of radiography. *Su; preq. RDLT 103 and 201*
- RDLT 105 Radiologic Technology 5 (3)** Continuation of RDLT 104 with emphasis on vascular and neurological examination, including analysis of equipment used. *F; preq. RDLT 104*
- RDLT 106 Radiologic Technology 6 (3)** Examination of advanced radiographic techniques and imaging modalities, quality control, fluoroscopy, image intensifiers, conventional tomography, stereo radiography, xeroradiography, computed tomography, magnetic resonance imaging, ultrasound, and other specialized areas of imaging. *W; preq. RDLT 105*
- RDLT 107 Radiologic Technology 7 (3)** A series of lectures on pathologic conditions and their impact on the radiographic process. Includes student participation in film evaluation and case studies. *Sp; preq. RDLT 106*
- RDLT 108 Radiologic Technology 8 (2)** Designed as a self assessment of the independent cognitive areas utilized in the clinical situation. *Su; preq. RDLT 107 and 113*
- RDLT 111 Radiologic Physics (4)** A study of the fundamentals of matter, electrostatics, electrostatics, magnetism, rectification, production, and properties of x-rays, x-ray tubes, and x-ray circuitry. *F; preq. MATH 130 and RDLT 104*
- RDLT 112 Radiobiology and Radiation Protection (3)** Lectures on the radiobiological areas of radiation interactions, radiosensitivity, radiation dose/response relationships, early and late radiation effects, radiation protection, and health physics. *W; preq. RDLT 111*
- RDLT 113 Radiographic Processing (2)** Includes discussions of film characteristics, artifacts, film storage and handling, processing room design and function, methods, principles and chemistry of processing systems, silver reclamation, and quality control. *Sp; preq. RDLT 112 and 201*
- RDLT 200 Basic Patient Care (3)** Provides knowledge and basic skills necessary for care of the patient. Includes medical and professional ethics, medical terminology, and interpersonal relationships. *W; preq. RDLT 101*
- RDLT 201 Radiographic Exposure (4)** Lectures on establishing and manipulating radiographic exposure factors and on the proper utilization of accessory devices such as grids, intensifying screens, and beam limitation devices. Concentration is on overall image quality, as well as factors affecting patient exposure. *Sp; preq. RDLT 102*

- RDLT 211 Clinical Experience 1 (2)** Practical application of radiologic technology principles, positioning, and techniques with emphasis on upper and lower extremity examinations in the radiology departments of affiliate hospitals. Includes film critique sessions. *Sp; preq. RDLT 102*
- RDLT 212 Clinical Experience 2 (3)** Continuation of RDLT 211 with emphasis on spine and skull examinations. *Su; preq. RDLT 211*
- RDLT 213 Clinical Experience 3 (3)** Continuation of RDLT 212 with emphasis on urographic, biliary, and gastrointestinal examinations. *F; preq. RDLT 212*
- RDLT 214 Clinical Experience 4 (3)** Continuation of RDLT 213 with emphasis on gastrointestinal, portable, and advanced bonework examinations. *W; preq. RDLT 213*
- RDLT 215 Clinical Experience 5 (3)** Continuation of RDLT 214 with emphasis on headwork, surgery, and advanced radiographic examinations. *Sp; preq. RDLT 214*
- RDLT 216 Clinical Experience 6 (4)** Continuation of RDLT 215 with emphasis on advanced imaging modalities. *Su; preq. RDLT 215*
- RDLT 312 Sectional Anatomy (3)** This lab-oriented course is designed to introduce students to human anatomy displayed in sections. Emphasis is on anatomical structures visualized in computed tomography, magnetic resonance imaging, and ultrasonography. *Sp; preq. BIOL 162, 310, or instructor permission; 2 lec. 2 lab*
- REST 101 Real Estate Mathematics Applications (3)** Designed to provide the mathematical skills and background necessary for a real estate salesperson, broker, appraiser, or property manager. Topics include commissions, points, mortgage interest and principal, real estate taxes, prorating, investment analysis, and percentage leases. *Not regularly offered*
- REST 210 Real Estate Principles and Practices (4)** Introduction to real estate economics and administration. Includes elementary physical, legal, locational, and economic characteristics of real estate; real estate markets; and national, regional, and local economic influences on real estate values. Serves as a preparation for securing a license. *F*
- REST 212 Real Estate Law (4)** Includes the law of agency as applied to real estate brokers and salesmen, law of fixtures, estates (including leases), conveyancing of real estate, real estate managers, license laws of Ohio, zoning, cooperatives, and condominiums. *F*
- REST 213 Real Estate Finance (4)** Includes the nature and characteristics of mortgage loans, government influence on real estate finance, the mortgage market, and the effects of monetary and fiscal policies on real estate financing. Concepts and measurements of value, cash flow, leverage, and tax shelters are emphasized. *W*
- REST 214 Real Estate Appraisal (4)** Emphasizes the methodology of appraising urban real property and the theory underlying appraisal techniques. In-depth study of market comparison, penalized cost of replacement, and income capitalization. A term project provides practical experience in applying these techniques. *Sp*
- REST 215 Real Estate Brokerage (4)** Basics of real estate economics, brokerage, and administration. Designed for the professional development of real estate personnel and for those who are not in the real estate business but who wish to increase their general knowledge. *Not regularly offered*
- REST 299 Special Topics in Real Estate (1-4)** Opportunity for the student to work on special projects under the supervision of an instructor with expertise in the area of the student's project. *Not regularly offered; preq. instructor permission; see special note on page 84.*
- RMMT 103 Introduction to Retailing (4)** Principles and methods of retail management, including organization, policy making, location, operation, selling services, records, inventory, expense control, insurance, and the coordination of a retail business. *Sp; preq. BMNT 102*

RMMT 104 Salesmanship (4) Basic concepts of personal selling at both the industrial and retail level, including preparation for selling, sales processes, and an introduction to sales management. Emphasis on retail selling, with a discussion of career opportunities. *W; preq. BMNT 102*

RMMT 223 Retail Buying (4) Introduction to the complexity of the retail buyer's responsibilities and functions. Topics include how to determine what to buy, how much to buy, and how to price merchandise. Merchandising mathematics skills are also developed. *Not regularly offered; preq. BMNT 102*

RMMT 225 Marketing Case Studies (4) Discussion of marketing problems in a group situation. Problems include marketing management, production planning and development, marketing research, industrial buying behavior, market segmentation, price objectives, advertising, and international marketing environment. *F; preq. BMNT 102*

RMMT 235 Advertising (4) A study of the principles of advertising, including the history and development of advertising, its relation to the marketing effort of the firm and to consumers and society in general, and the major groups of media used by the advertiser. *Sp; preq. BMNT 102*

RMMT 239 Practical Business Applications (1-4) Student participates in an off-campus work experience with a business specializing in the student's area of interest. One credit hour is awarded for a minimum of **seven scheduled clock hours** of such activity **per standard work week**. *Not regularly offered; preq. advisor permission*

RMMT 240 Practical Retail Advertising (4) Designed to give hands-on experience in the selection of media and the actual development of advertisements. *Not regularly offered; preq. MRKT 310 or BMNT 102*

RMMT 299 Special Topics in Retailing/Sales/Advertising (1-4) Opportunity for the student to work on special projects under the supervision of an instructor with expertise in the area of the student's project. *Not regularly offered; preq. instructor permission; see special note on page 84.*

RPTT 101 Basic Patient Care (3) Introduction to respiratory therapy as a profession and to basic clinical assessment and care of patients. Professional duties and responsibilities, ethics and liability, and basic patient care skills (patient assessment, record keeping, patient monitoring, pulmonary care techniques) are included. *F; preq. admission to respiratory therapy program; 2 lec. 3 lab*

RPTT 102 Cardiopulmonary/Renal Anatomy and Physiology (5) Detailed presentation of the anatomy and physiology of the pulmonary, cardiac, and renal systems. Topics include basic structure and function, system interactions, and basic pathophysiology with emphasis on the pulmonary system. *F; preq. admission to respiratory therapy program*

RPTT 110 Medical Gas Therapy (4) Presentation of topics related to the production, handling, and administration of medical gases, including humidity and aerosol therapy, medical gas therapy, equipment required for their administration, and the indications, contraindications, and hazards of their use. *W; preq. RPTT 100, 101, and 102; 3 lec. 3 lab*

RPTT 115 Clinical Application 1 (1) Introduction to the clinical setting, orientation to the hospital, and an opportunity to practice those skills and techniques learned in RPTT 101 and 110. *W; preq. RPTT 100, 101, and 102; 8 clinical*

RPTT 120 Perioperative Care (4) Detailed discussion of respiratory therapy techniques used before and after surgery to minimize complications. Topics include respiratory pharmacology, incentive spirometry, bronchopulmonary drainage, and intermittent positive pressure breathing. *Sp; preq. RPTT 110 and 115; 3 lec. 3 lab*

RPTT 121 Airway Management (2) A study of artificial airways, airway obstruction, and defense mechanisms of the lungs. Topics include design, selection, and insertion of artificial airways as well as protective mechanisms of the lungs. *Sp; preq. RPTT 110 and 115; 1 lec. 3 lab*

RPTT 125 Clinical Application 2 (1) Continuation of RPTT 115, with emphasis on the application of skills and techniques learned in RPTT 120 and 121. *Sp; preq. RPTT 110 and 115; 8 clinical*

RPTT 130 Pediatric and Neonatal Respiratory Care (4) Study of the pathology, pathophysiology, diagnosis, and treatment of diseases of the newborn and pediatric patient. Topics include developmental and comparative anatomy and physiology and specific respiratory care considerations required for these age groups. *Su; preq. RPTT 120, 121, and 125*

RPTT 131 Pulmonary Function Testing (2) Study of the methods used for testing the function of the lungs. Topics include the indications and standards for testing, equipment used, interpretation, and quality control systems. *Su; preq. RPTT 120, 121, and 125*

RPTT 132 Arterial Blood Gases/Acid Base (1) Study of the techniques for collecting and analyzing arterial blood samples and detailed discussion of the interpretation of results. Emphasis on acid-base, fluid, and electrolyte balance and regulation. *Su; preq. RPTT 120, 121, and 125*

RPTT 133 Laboratory Procedures (1) Laboratory practice of the skills discussed in RPTT 131 and 132. *Su; preq. RPTT 131 and 132*

RPTT 135 Clinical Application 3 (2) Continuation of RPTT 125, with emphasis on those skills developed in RPTT 131, 132, and 133. *Su; preq. RPTT 120, 121, and 125*

RPTT 200 Pharmacology (3) Study of the general principles of pharmacology, including drug types, methods of administration, dosage, effects, indications, contraindications, and regulation. Drug groups related to respiratory care are emphasized, including bronchodilators, wetting agents, mucolytics, antibiotics, muscle relaxants, and corticosteroids. *F; preq. RPTT 130, 131, 132, 133, and 135*

RPTT 201 Continuous Mechanical Ventilation (6) Study of the therapeutic and diagnostic techniques used for patients receiving mechanical ventilatory support. Topics include the selection process for ventilators, indications and hazards of mechanical ventilation, maintenance of patients, respiratory and hemodynamic monitoring, and weaning of patients from ventilatory support. *F; preq. RPTT 130, 131, 132, 133, and 135; 5 lec. 3 lab*

RPTT 202 Pathophysiology (3) Study of the etiology, diagnosis, pathophysiology, and treatment of some of the most commonly encountered cardiopulmonary diseases. Topics include chronic obstructive pulmonary diseases and common restrictive, pleural, occupational, and cardiac related diseases. *F; preq. RPTT 130, 131, 132, 133, and 135*

RPTT 205 Clinical Application 4 (2) Continuation of RPTT 135 with emphasis on the skills and techniques learned in prerequisite courses. *F; preq. RPTT 130, 131, 132, 133, and 135; 16 clinical*

RPTT 210 Critical Care (2) Study of the assessment, monitoring, and treatment of the acutely ill and traumatized patient. *W; preq. RPTT 200, 201, 202, and 205*

RPTT 211 Advanced Cardiopulmonary Assessment (1) Study of advanced techniques for the monitoring of cardiopulmonary function. *W; preq. RPTT 200, 201, 202, and 205*

RPTT 212 Pulmonary Rehabilitation and Home Care (2) Study of the care and management of patients receiving pulmonary rehabilitation or home care. Topics include patient selection, education, follow-up, program design, progress assessment, regulatory implications, and equipment. *W; preq. RPTT 200, 201, 202, and 205*

RPTT 213 Department Management (1) Introduction to the organization, planning, and management of, as well as the effect of current governmental regulations on, respiratory services. *W; preq. RPTT 200, 201, 202, and 205*

RPTT 215 Clinical Application 5 (3) Continuation of RPTT 205, with emphasis on the skills and techniques learned in RPTT 201. *W; preq. RPTT 200, 201, 202, and 205*

RPTT 220 Seminar (4) Designed to provide final curricular preparation for graduation. Includes oral case presentation, program assessment, systematic content review, and a comprehensive, cumulative student evaluation. *Sp; preq. RPTT 225; coreq. RPTT 225*

RPTT 225 Clinical Application 6 (8) Continuation of RPTT 215 with emphasis on skills and knowledge developed in RPTT 130, 201, 210, 211, 212, and 213. *Sp; preq. RPTT 115, 125, 135, 205, and 215*

SBMT 225 Organization and Operation of Small Business (4) A course designed to provide the basics of small business: getting started, financial recordkeeping, cash flow management, computers, human resource management, marketing, pricing, advertising, and promotion. *F; required in two-year concentration in small business management.*

SBMT 236 Franchising (4) A course designed for students of franchising and for those considering going into business as either a franchisor or a franchisee. Nature of franchising, franchising and the law, developing and operating the franchise business, the franchise arena, franchisee/franchisor relationships. *Not regularly offered; required in two-year concentration in small business management.*

SBMT 290 Seminar in Small Business Problems (4) A course designed to acquaint the student with actual small business problems; structured through the Small Business Institute of the Small Business Administration and classroom case studies. *Not regularly offered; required in two-year concentration in small business management; preq. SBMT 225*

SBMT 299 Special Topics in Small Business Problems and Entrepreneurship (1-4) Opportunity for the student to work on special projects under the supervision of an instructor with expertise in the area of the student's project. *Not regularly offered; preq. instructor permission; see special note on page 84.*

SOCI 101 Introduction to Sociology (4) Studies the nature of human society and factors affecting its development, including concepts of culture, groups, organizations, collective behavior, and institutions. Required course for all social science majors. *Su F W Sp*

SOCI 110S Foundations of Social Science (4) Introduction to the methods and concerns of social science. Studies perspectives of anthropology, economics, history, geography, political science, psychology, and sociology as related to specific themes or topics. Part of general education core requirement. *Su F W Sp*

SOCI 150 Principles of Statistics (4) Cross-listed as MATH 150 and PSYC 150. Introduction to the vocabulary, concepts, formulas, and presentation of statistics as applied to business, education, and science. Topics include measures of central tendency and dispersion, probability applied to joint probability tables and Bayes' Theorem, probability distributions with emphasis on Binomial and Normal, sampling practices and theory, and calculator and computer use. *Preq. MATH 101*

SOCI 199 Special Topics in Sociology (1-4) Individual or small-group study, under the supervision of instructor, of topics not otherwise available to students.

SOCI 201 Introduction to Social Welfare (4) Overview of the field of social welfare: fundamental concepts and services in social welfare, social policies, historical development.

SOCI 203 Social Organization of Work (4) Examines the history, methods, and context of work. Emphasis on the sociological perspectives of work, industry, and occupations. The future of the workplace is examined.

SOCI 204 Introduction to Social Work (4) Introduces students to the profession of social work. Includes an overview of the historical development of social work as a profession; social work practices with individuals, groups, and communities; and theory and practice of social work. *F Sp*

SOCI 205 Current Social Problems (4) An overview of major perspectives on social problems and their relevance in contemporary life. Topics include poverty, sexism, racism, aging, alienation, crime, human ecology, and colonialism in the third world. *F; preq. SOCI 101*

SOCI 210 Women in Society (4) A study of women's roles in society analyzed from a historical, cross-cultural, and sociological perspective. Examination of the position of women in a changing society.

SOCI 224 Urban Sociology (4) Ecological and nonecological theories are used to study the processes of urbanization and the involvements and problems of the urban community. *Preq.* SOCI 101

SOCI 227 Sociology of Education (4) Social organization of education and teaching as a profession. Examines class, ethnic, and other social factors affecting the educational process. Focuses on educational institutions and their relationship to the community. *Preq.* SOCI 101

SOCI 234 Sociology of Aging (4) Various aspects of aging are examined with special emphasis on theories of aging, demographics, physical, psychological, and sociological aspects of the aging process. *Sp*

SOCI 299 Topics in Sociology (1-4) Separate courses repeatable for credit on topics not otherwise available to students.

SOCI 303 Introduction to Social Psychology (4) Cross-listed as PSYC 303. Behavior of the individual as influenced by other individuals, social groups, and culture. Examines group dynamics, leadership, attitude, and group conflict. *Preq.* PSYC 101

SOCI 305 Social Work Practice (4) Social work theory, methodology, and application. Areas of study include theory and concept formation, research design, data collection, client-worker relationship, interviewing, and problem-solving. *W; preq.* SOCI 201 or 204

SOCI 310 Gender Socialization (4) Focuses on the socio-cultural dynamics involved in the socialization process. Examines differential expectations, male and female identity formation, sex roles in the family, occupational stereotypes, and the changing nature of sex roles. *F W; preq.* SOCI 101

SOCI 311 Human Sexuality (4) Cross-listed as PSYC 311. An in-depth view of the current status of human sexuality in the U.S. Examines current research; modes of sexual expression and enhancement; physiological, sociological, and psychological basis of human sexuality; sexual variations; and sex ethics.

SOCI 312 Sociology of Religion (4) General theories concerning the place of religion in social processes. Religion and its place in the modern world, secularization, fundamentalism, new movements; religion in relation to class, ethnicity, gender, politics, and education. Durkheim's work on religion as the basis of social order and Weber's work on religion and the rationalization process are emphasized.

SOCI 325 Sociology of the Family (4) Historical perspective for understanding American family systems. Of central concern are the contemporary marriage process and context, family relationships, sexuality, family dysfunctions, and changes. *W; preq.* SOCI 101

SOCI 326 Small Group Dynamics (4) Analysis of small-group structure and processes; examination of roles, interpersonal relations, and leadership; and current theory and research on small group interaction. *Sp odd years; preq.* SOCI 101

SOCI 330 Social Theory (4) A study of major classical and contemporary sociological theories and their exponents. *W; preq.* SOCI 101

SOCI 340 Sociology of Appalachia (4) Intensive study of Appalachia from sociological perspective. Emphasizes demography of Appalachia, sub-cultural characteristics, religion, arts and crafts, social change, and community power in Appalachia. *Sp even years; preq.* SOCI 101 or by permission

SOCI 360 Drugs/Substance Abuse (4) Cross-listed as PSYC 360 and HPER 360. An in-depth study of alcohol, tobacco, and other drugs and how chemical dependency on these drugs can affect individual performance and behavior.

SOCI 380 Sociological Methods (4) Overview which includes scientific method, measurement, experimentations, survey research, observational methods, case study techniques, and content analysis. *Sp even years; preq. SOCI 101*

SOCI 399 Special Topics in Sociology (1-4) Individual or small-group study, under the supervision of instructor, of topics not otherwise available to students.

SOCI 400 Complex Organizations (4) Sociological analysis of complex organizations. Topics include theories, types of organizations, organizational change and conflict, and research in organizations. *Preq. SOCI 101*

SOCI 403 Field Experience in Social Work (4) Controlled experience in a social work setting supervised by a qualified professional in an established agency. Designed to expose students to realistic conditions and "hands-on" learning. *Preq. SOCI 204 and 305*

SOCI 405 Death and Dying (4) Cross-listed as PSYC 405. Focus on increased ability to deal with one's own mortality; skills for working with terminally ill and their families; understanding the complex social system of death in American society; and moral, ethical, and philosophical issues surrounding death. *Preq. PSYC 101 or SOCI 101*

SOCI 410 Social Stratification (4) Analyzes stratification in the U.S. and other societies, focusing on income and wealth, role of family and education on social mobility, and inequality and influence of social class on public policy. *Preq. SOCI 101*

SOCI 425 Industrial Sociology (4) Focuses on the growth of technology in the U.S. Emphasizes the social organization of industry, life in the work place, and the organizational culture. *Preq. SOCI 101*

SOCI 429 Contemporary Minority Relations (4) Basic approaches are used to analyze American minority groups and their contemporary situation. Special emphasis is placed on patterns of prejudice and discrimination as well as the dynamics of race relations. *Preq. SOCI 101*

SOCI 444 Social Deviance (4) Examination of the concept of deviance in sociology and its implications for the study of contemporary social behavior. How people develop a concept of some being different from others and act on this definition. Possible topics include mental illness, crime, sexual deviance, non-conformity, and subcultures of deviance. *Preq. SOCI 101*

SOCI 450 Sociology of Occupations and Professions (4) Sociological analysis of contemporary occupations and professions in the U.S., social stratifications in the work place, technology, and the individual in the work place. *Preq. SOCI 101*

SOCI 485S Community Involvement (Core Course) (2) Community Involvement is an outgrowth of the purposes and objectives of the University. The series of activities integral to the Community Involvement course enhance the education of the student, complement the senior seminar, and promote reflection on the student's obligation to human beings in need and society at large. *(not offered summer quarter)*

SOCI 490S Senior Seminar (Core Course) (4) This course provides an opportunity for students to place their chosen field of study in an interdisciplinary context with intellectual, ethical, and historical perspectives. The seminar focuses on the synthesis and integration of various concepts by applying them to the analysis and solution of problems chosen in the context of their academic disciplines. Oral and written presentations of the seminar paper are required. *Preq. senior standing and 44 core hours*

SOCI 499 Special Topics in Sociology (1-4) Individual or small-group study, under the supervision of instructor, of topics not otherwise available to students. Separate courses repeatable for credit. *Preq. SOCI 101*

SPAN 111 Elementary Spanish 1 (4) Development of comprehension, speaking, reading, and writing skills in a cultural context. Basic grammar. Lab required. Initial course of three-quarter, first-year sequence. *Su F W Sp*

- SPAN 112 Elementary Spanish 2 (4)** Continuation of SPAN 111. *F W Sp; req. SPAN 111*
- SPAN 113 Elementary Spanish 3 (4)** Continuation of SPAN 112. *F W Sp; req. SPAN 112*
- SPAN 211 Intermediate Spanish 1 (4)** Offers selected readings in Hispanic issues and literature to continue the development of communicative skills. Lab required. *F W Sp; req. SPAN 113 or 2-3 years of high school Spanish*
- SPAN 212 Intermediate Spanish 2 (4)** Continuation of SPAN 211. *F W Sp; req. SPAN 211 or instructor's approval*
- SPAN 213 Intermediate Spanish 3 (4)** Emphasizes the ability to read with detailed understanding, creative and accurate use of vocabulary items, use of subordinate structures in oral communication, and the ability to communicate in writing using complex sentence structures. *F W Sp; req. SPAN 212 or instructor's approval*
- SPAN 311 Composition and Conversation (4)** A follow-up to SPAN 213 with special emphasis on oral proficiency and applied grammatical concepts. In preparation to reading and writing, contemporary videos and films are used to stimulate discussion. *Offered on demand; req. SPAN 213 or fluency in Spanish communicative skills*
- SPAN 399 Special Topics (1-4)** Designed for native speakers of Spanish or nonnative speakers who have acquired communicative skills in the language. The course analyzes the work of contemporary Latin-American writers, as well as Hispano-American writers in the U.S. *Offered on demand; req. native speaker fluency in communicative skills (listening, speaking, reading, and writing)*
- SPCH 103 Public Speaking and Human Communication (3)** Principles of public speaking and practice in presenting informative and persuasive speeches with emphasis on the human communication process. *Su F W Sp*
- SPCH 105 Introduction to Mass Communication (4)** Study of all forms of mass communication, including newspapers, magazines, radio-television, book publishing, public relations, advertising, and photojournalism. Begins with an analysis of communication process and ends with media career opportunities. *Offered on demand*
- SPCH 215 Group Discussion (4)** Study of structure and internal dynamics of small groups, nature and functions of leadership and group participation, and problem solving and decision making. Frequent participation in group discussion activities. *Offered on demand*
- SPCH 220 Oral Interpretation of Literature (4)** Techniques of oral interpretation and development of adequate intellectual and emotional responsiveness to meaning of literature. *Offered on demand*
- SPCH 299 Topics in Communications (1-4)** Study of various topics not otherwise available to students. Repeatable for credit. *Offered on demand*
- THAR 100 Introduction to Theater (3)** Survey of development of theater from classical to modern times, emphasizing the artist and craftsmen of the theater and their contributions to its development. *F W Sp*
- THAR 120 Introduction to Stagecraft (3)** Scenic materials and techniques of planning and constructing stage scenery. Stage audience relationships and principles of technical production. *F W Sp*
- THAR 121 Stage Lighting (3)** Theory and practice in the mechanics and design of lighting for theatrical productions. *Sp*
- THAR 122 Introduction to Costume (3)** Principles of technical production. May be repeated for credit. *F W Sp; 2 lec. 1 lab*

THAR 132 Elements of Performance (4) Introduction to the elements of performance that create theater and drama, including text, performer, spectacle, spectator, and performance space. Attendance at university theater productions is required. *F W Sp*

THAR 135 Practicum in Production Design (2-4) Supervised lab practice in design and execution of scenery, lighting, costumes, properties, and sound. May be repeated for credit. *F W Sp*

THAR 205 Theater Planning and Management (3) Principles and practices of managing theatrical-producing organizations. Problems of finance, personnel, policy, program building, advertisement, publicity, and public relations. *W*

THAR 210 Acting 1 (4) Principles and techniques of acting with major emphasis on developing trust and freedom. Warm-up techniques, theater games, improvisation, monologue exercises, and preliminary scoring techniques underline this introduction to the work of the actor. *F W Sp*

THAR 211 Acting 2 (4) Continuation of training started in THAR 210, with addition of more detailed character development, scoring techniques, and ensemble considerations through duet scene work. *W Sp*

THAR 212 Acting 3 (4) For serious acting student, this course completes the second year sequential training program. Primary emphasis is to apply techniques learned in THAR 210 and 211 to more lengthy and complicated scene structures. Long duet scenes and multi-character scenes or short plays used for study and performance. Public performances are frequently incorporated into final work in this course. *Sp*

THAR 235 Practicum in Production Design (2-4) Supervised lab practice in design and execution of scenery, lighting, costumes, properties, and sound. May be repeated for credit. *F W Sp; req. instructor's permission*

THAR 237 Stage Make-up (2) Stage make-up materials and the art of pigment application. *F W Sp*

THAR 331 Directing 1 (4) Principles and practices of directing for stage. *F W Sp*

THAR 332 Theater History (3) Development of theater and drama. May be repeated for credit. *Offered on demand*

UNIV 101 Academic Development Skills (4) A course recommended for students who place in at least two developmental education courses and optional for any student on campus. Recommended for entering freshmen with a high school GPA of 2.0 or lower. Teaches study skills and test-taking techniques. Emphasis on goal setting, time management, notetaking, studying and marking textbooks, taking exams, finding and using learning resources, improving memory and concentration, and skimming and scanning. *Su F W Sp*

UNIV 102 Personal Development Skills (4) A course recommended for students who place in at least two developmental education courses and optional for any student on campus. Designed to help students improve their personal skills in order to become more involved members of the academic community and to have richer personal lives. Topics include attitudes, self-esteem, communication, wellness/health, anxiety and stress, creativity, problem-solving, money management/personal finance, career exploration, and orientation to university services. *Su F W Sp*



Board of Trustees

Thomas R. Winters, Chairperson
Frank D. Hyland
Jeff M.S. Kaplan
Thomas Reynolds
Patricia J. Richards
Verna K. Riffe
William J. Shkurti
Frank L. Waller
Rebecca Greene, Student

Administration

Addington, A. L. (1987)
Provost and Vice President for Academic Affairs
B.S., East Tennessee State
M.S., Ph.D., University of Tennessee

Arnzen, James W. (1988)
Director, Athletics
Head Basketball Coach
B.S., Defiance College
M.S., University of Dayton

Bankey, Michael L. (1990)
Assistant Director, Admission
B.A., University of Findlay
M.A., Bowling Green State University

Beckett, Grant E. (1983)
Director, Developmental Education/Learning
Center
A.B., M.A., Ph.D., Ohio University

Boyles, Elinda C. (1988)
Director, Personnel
B.S., Eastern Kentucky University
M.Ed., University Nevada Las Vegas

Bradbury, Barbara L. (1980)
Director, Upward Bound Program
B.S., Ohio University
M.S., University of Dayton

Burchett, Mark (1991)
Science Laboratory Assistant
Department of Natural Sciences
College of Arts and Sciences
B.S., M.S., Morehead State University

Campis, Adora (1992)
Coordinator, G.R.O.W. Program
B.A., SUNY at Stonybrook, Long Island
M.A., SUNY at Stonybrook, Long Island
M.S., Ph.D., Columbia University

Carson, Pat L. (1984)
Manager, Printing and Graphic Services

Charles, Joanne T. (1988)
Accounting Supervisor
B.B.A., Temple University
M.B.A., Morehead State University

Charles, Thomas K. (1979)
Director, Transfer Placement
A.S., Henry Ford Community College
B.S., M.A., Western Michigan University

Chrisman, Frederick, Jr. (1969)
Director, Student Activities
B.S., Ohio University
M.Ed., Xavier University

Come, Gene (Scott) (1971)
Associate Provost for Academic Affairs
B.A., West Virginia Wesleyan
M.A., Indiana University of Pennsylvania
Ph.D., Ohio University

Crabtree, Paul D. (1975)
Vice President for Student Affairs
B.S.Ed., M.Ed., Ph.D., Ohio University

Creamer, David (1992)
Vice President for Business Affairs
B.B.A., Ohio University
M.S., Ph.D., Kent State University

Culver, Tim (1990)
Coordinator, GED Program
B.B.A., Ohio University
M.B.A., Marshall University

Cummings, Mary Elizabeth (1988)
Librarian, Reference
B.S.Ed., Ohio University
M.S.L.S., University of Kentucky
M.A., Marshall University

Day, Michael E. (1990)
Accountant
A.A.B., B.B.A., Shawnee State University

Duncan, William Peter (1983)
Associate Director, Library/Media Services
B.S., Ohio University

Evans, Cynthia J. (1981)
Manager, Purchasing
A.A., Shawnee State Community College
B.S.Ed., M.Ed., Ohio University

Evans, Danny L. (1981)
Assistant Vice President, Academic Affairs
B.S.Ed., Ohio University
M.A.Ed., Morehead State University
Ph.D., Ohio University

Fowler, Paul (1971)
Director, SOCF Programs
B.S., L.L.B., J.D., The Ohio State University

Gilmore, Patricia (1990)
Coordinator, Disability Services
B.S., Ohio University

Gleason, David L. (1983)
Director, Planning, Physical Facilities, and
Construction
B.S., Ohio University
M.A., The Ohio State University
Ph.D., Ohio University

Gregory, Stephen (1989)
Assistant Director, Admission
A.A.B., Hocking Technical College
B.B.A., Ohio University

Gross, Carolyn (1990)
Coordinator, Shawnee BASICS
B.A., West Virginia Institute of Technology
M.A., West Virginia University

Grundler, Mark W. (1992)
Software Applications Manager
A.S., Iowa Technical Institute
B.S., University of Iowa

Hannah, William A. (1987)
Coordinator, Media Services
B.S., Ohio University

Hanson, Allen (1992)
University Center Manager
M.S., Morehead State University

Hartley, Jannette S. (1992)
Librarian, Technical Services
A.A., A.A.S., Highline Community College
B.A., Washington College
M.I.L.S., University of Michigan

Howard, Richard R. (1971)
Director, Counseling and Career Services
B.S., The Ohio State University
M.Ed., Eastern Kentucky University

Hughes, Michael J. (1990)
Counselor, Counseling and Career Services
B.S., M.S., University of Scranton
Ed.D., West Virginia University

Jahnke, Jessica (1990)
Dean, Center for Teacher Education
B.S., Silver Lake College
M.A., Roosevelt University
Ph.D., The Ohio State University

Kadel, James R. (1981)
Dean, College of Health Sciences
B.A., D.D.S., The Ohio State University
M.Ed., Cleveland State University
M.B.A., Ohio University

Keaton, Mary (1981)
Bookstore Manager

Kotcamp, Lloyd "Butch" (1990)
Maintenance Supervisor

Lawson, Robert L. (1990)
Director, Continuing Education
B.S., University of Rio Grande
M.A., Marshall University
Ed.D., Nova University

Lawyer, Sandra K. (1991)
Counselor, JOBS Student Retention Program
A.I.S., Shawnee State University
B.B.A., M.Ed., Ohio University

Madden, Paul M. (1992)
Teacher Education Certification Assistant
B.S., University of Dayton

Martin, Charles (1978)
Custodial Supervisor

Matthews, Eustace P. (1990)
Director, Student Support Services
B.A., M.Ed., Ohio University

McClintock, Maggie (1991)
Director, University Information Systems
B.S., San Diego State University
M.B.A., Ohio University
C.D.B., I.C.C.P.

McHenry, Candace (1991)
Coordinator, Clinical/Field Experiences
Center for Teacher Education
B.S., Ohio University
M.A., Marshall University

Midkiff, Stephen J. (1977)
Registrar
B.A., University of Kentucky
M.Ed., Harvard University
Ph.D., Ohio University

Midkiff, Tess D. (1975)
Director, Library/Media Services
B.A., University of Kentucky
M.L.S., Simmons College

Miller, Brenda M. (1991)
Counselor, JOBS Student Retention Program
B.A., B.S., M.A., The Ohio State University

Moore, Mark A. (1987)
Assistant Registrar
A.A.S., Shawnee State Community College
B.A., Ohio University

Moore, Patricia J. (1971)
Administrative Assistant to the President
A.S., Shawnee State University
B.B.A., Ohio University

Mowery, Steven D. (1992)
User Support Manager
A.A.B., Shawnee State University

Mullins, Cathy (1990)
Assistant Director, Continuing Education/
Special Programs and Community Services
B.S., M.B.A., Ohio University

Nibert, Marilyn J. (1988)
Administrative Assistant to the Provost
A.A.B., Shawnee State University

Ottens, Bruce (1990)
Assistant Dean, College of Engineering
Technologies
B.S., M.Ed., Bowling Green State University

Payne, Roy B. (1988)
Dean, College of Business
B.S., Morris Harvey College
M.B.A., Indiana University

Pinson, Michael (1990)
Engineering Technologies Technician
College of Engineering Technologies
A.A.S., Shawnee State University

Poston, Rosemary K. (1986)
Director, Admission
B.S., Ohio Dominican College
M.A., The Ohio State University

Powell, Sherri (1989)
Accountant/Budget Analyst
A.A.B., Shawnee State Community College
B.B.A., Ohio University

Ramey, Virginia C. (1984)
Director, Tech Prep
B.S.Ed., M.B.A., Ohio University

Salyers-Stoner, Connie E. (1988)
Associate Director, Library/Public Services
B.S., Wright State University
M.L.S., George Peabody College for Teachers

Trustees and Staff

1993-1995
Shawnee State University

233

Schultz, Lucinda A. (1984)
Sports Center Manager
B.S., Rio Grande College
M.S., Ohio University

Shelpman, Suzanne (1991)
Director, JOBS Student Retention Program
B.A., M.A., Marshall University

Syroney, Jeanie (1990)
Coordinator, ECEP/EMT
A.A.S., Shawnee State University

Taylor, Dale F. (1988)
Counselor, JOBS Student Retention Program
A.I.S., Shawnee State Community College
B.G.S., Ohio University
M.H.E., Morehead State University
L.S.W., State of Ohio

Travis, Dennis M. (1991)
Dean, College of Arts and Sciences
B.S., M.Ed., Edinboro University
Ph.D., Miami University

Veri, Clive C. (1989)
President
B.S., State University of New York at Oswego
M.A., University of Maryland
Ph.D., University of Nebraska

Vournazos, Rick (1988)
Assistant Director, Admission
B.B.A., Ohio University
B.S.Ed., Ohio University
M.B.A., Xavier University

Walker, Charles Melton (1987)
Programmer II, University Information Systems
A.A.B., Shawnee State University
B.A., Ohio University

Warman, Randy (1992)
University Center Manager
B.S., Ohio University

Warsaw, Susan S. (1983)
Director, Development and Community
Relations
B.A., The Ohio State University

Watson, Deborah, E. (1991)
Counselor, JOBS Student Retention Program
B.A., M.A., Morehead State University

Welton, John D., Sr. (1988)
Bursar
A.A.B., Shawnee State Community College
B.A., Ohio University

Wilburn, Teresa (1991)
Programmer II, University Information Systems
A.A.S., B.B.A., Shawnee State University

Wilson, Eugene D. (1974)
Director, Financial Aid/Veterans' Coordinator
B.S., Ohio University
M.A., Xavier University

Winters, David Z. (1989)
Dean, College of Engineering Technologies
B.S., M.S., University of Dayton

Young, F. Daniel (1990)
Assistant Director, Facilities
A.I.E., Muskingum Area Technical College

Faculty

Abel, Joanne S. (1978)
Chairperson, Associate Professor
Associate Degree Nursing
College of Health Sciences
B.S.N., Alderson-Broaddus College
M.A., University of West Virginia College of
Graduate Studies

Alex, Alexander V. (1988)
Professor, Economics
College of Arts and Sciences
B.A., Kerala University
M.A., Banaras University
M.A., Ph.D., Indiana University

Barry, Gerald E. (1980)
Senior Instructor, Data Processing
College of Business
B.S.C., Ohio University

Basham, Julia L. (1982)
Associate Professor, Biological Sciences
College of Arts and Sciences
B.A., B.S., M.S., University of Cincinnati
M.S., Marshall University

Bauer, Jeffrey A. (1987)
Chairperson, Associate Professor
Department of Natural Sciences
College of Arts and Sciences
B.S., Bowling Green State University
M.S., Ph.D., The Ohio State University

Bostick, Trudy Ann (1977)
Senior Instructor, Mathematics
College of Arts and Sciences
B.S., Ohio University
M.S., Wright State University

Boukaabar, Kaddour (1990)
Assistant Professor, Mathematics
College of Arts and Sciences
B.S., University of Wahran, Algeria
M.S., Florida Institute of Technology
Ph.D., Bowling Green State University

Bowman, Thomas E. (1988)
Assistant Professor, Physical Education
Center for Teacher Education
B.S., M.A., West Virginia University

Bryson, Nancy M. (1991)
Assistant Professor, Chemistry
College of Arts and Sciences
B.S., Mississippi University for Women
M.A.T., Mississippi State University
Ph.D., University of South Carolina

Buchanan-Berrigan, Dawna Lisa (1991)
Associate Professor, Education
Center for Teacher Education
B.A., Brock University
M.A., Ph.D., The Ohio State University

Burke, Robbie A. (1974)
Professor, Management
College of Business
B.A., West Virginia Wesleyan
M.S., M.B.A., Marshall University

Byrne, Francis X. (1987)
Professor, English/Linguistics
College of Arts and Sciences
B.A., M.A., Colorado State University
M.A., Ph.D., University of Arizona

Canter, Mary Ann (1987)
Clinic Coordinator, Senior Instructor
Respiratory Therapy
College of Health Sciences
B.S.A.S., Youngstown State University
M.H.S.A., Ohio University

Carnevale, Thomas A. (1991)
Chairperson, Professor
Department of Mathematics
College of Arts and Sciences
B.S., St. Francis College
M.S.T., Fordham University
D.A., Idaho State University

Chaffin, Cathy M. (1980)
Associate Professor, Office Administration
College of Business
B.S., Berea College
M.B.E., Morehead State University

Chrisman, Elizabeth A. (1980)
Associate Professor, Dental Hygiene
College of Health Sciences
A.A.S., Scioto Technical College
B.S., M.Ed., Ohio University

Coll, Julia R. (1987)
Associate Professor, Spanish
College of Arts and Sciences
Licenciada en Educacion,
Universidad de Oriente
M.A., M.Ed., Ph.D., University of Arizona

Crothers, Shirley Evans (1968)
Associate Professor, Vocal Music
College of Arts and Sciences
B.S., The Ohio State University
M.F.A., Ohio University

D'Andrade, Kendall (1989)
Assistant Professor, Philosophy
College of Arts and Sciences
B.A., Colgate University
M.A., Temple University
Ph.D., University of Illinois at Chicago

Day, D. James (1987)
Associate Professor, Management
College of Business
B.S., West Liberty State College
M.B.A., Eastern New Mexico University
Ph.D., The University of Iowa

Deal, D. Robert (1988)
Associate Professor, Biology
College of Arts and Sciences
B.A., Capital University
M.A., Miami University
Ph.D., Cornell University

Diamond, Roger A. (1990)
Senior Instructor, Engineering
Graphics/CADD
College of Engineering Technologies
B.S., M.Ed., California University of
Pennsylvania

Dillard, Mary L. (1989)
Associate Professor, English
Developmental Education
B.S.Ed., M.S.T., Georgia Southern College
Ed.D., University of Tennessee

Dillon, Mary E. (1983)
Assistant Professor, Associate Degree Nursing
College of Health Sciences
B.S.N., Ohio University

Domo, Marlene A. (1990)
Associate Professor, Education
Center for Teacher Education
R.T., Marymont Hospital School
B.A., M.A., Josephinum College
Ph.D., The Ohio State University

Doster, Steven J., CPA, CMA (1989)
Associate Professor, Accounting
College of Business
B.S., The College of William and Mary
M.B.P.A., Southeastern University

Dzik, Anthony J. (1988)
Associate Professor, Geography
College of Arts and Sciences
B.A., Roosevelt University
M.A., University of Toledo
Ph.D., Northwestern University

Edwards, Barbara K. (1981)
Associate Professor, English
College of Arts and Sciences
B.A., University of Kentucky
M.A., Marshall University

Essman, Larry C., CPA (1976)
Associate Professor, Accounting
College of Business
B.A., M.A., Ohio University

Estep, Larry M. (1972)
Associate Professor, Management
College of Business
B.B.A., Ohio University
M.S., M.B.A., Marshall University

Ferguson, Orville R. II (1989)
Assistant Professor, Mathematics
Developmental Education
B.S., West Virginia State University
M.S. Ed.Ad., Xavier University

Flavin, James P. (1983)
Professor, English
College of Arts and Sciences
B.A., M.A., Fort Hays Kansas State University
Ph.D., Miami University

Forrey, Robert J. (1989)
Professor, English
College of Arts and Sciences
B.A./M.A., Wesleyan University
Ph.D., Yale University

Trustees
and Staff

- Frazee, R. Thomas (1967)
Associate Professor, Chemistry
College of Arts and Sciences
B.S., Marshall University
M.S., Iowa State University
- Friley, Jane M. (1981)
Assistant Professor, Associate Degree Nursing
College of Health Sciences
B.S.N., University of Kentucky
M.S.N., University of Tennessee
- Gallaher, Janna B., PE (1991)
Assistant Professor, Electrical and Computer
Engineering Technology
College of Engineering Technologies
B.S., St. Louis University
M.S., University of Missouri
- Gampp, Anna R. (1971)
Associate Professor, Associate Degree Nursing
College of Health Sciences
B.S.N., The Ohio State University
M.Ed., Ohio University
- Gaskill, Frank J. (1991)
Assistant Professor, Management
College of Business
B.A., Michigan State University
M.B.A., Eastern Michigan University
- Gearheart, Phillip H. (1987)
Professor, Art
College of Arts and Sciences
B.A., Wichita State University
M.S., M.F.A., Indiana University
- Gemmer, Gary P. (1983)
Associate Professor, Physics/Physical Science
College of Arts and Sciences
B.S., Morehead State University
M.A.T., Miami University
- Gilmer, Anita M. (1983)
Assistant Professor, Data Processing
College of Business
B.S., Indiana University of Pennsylvania
M.B.A., Morehead State University
- Goetting, Melvin J. (1987)
Assistant Professor, Data Processing
College of Business
B.B.A., M.B.A., University of Toledo
- Gulker, Emily E. (1965)
Associate Professor, Speech
College of Arts and Sciences
B.S.Ed., The Ohio State University
M.A., Marshall University
- Hadjiyannis, Stylianos I. (1989)
Associate Professor, Political Science
College of Arts and Sciences
B.A., California State University
M.A., Ph.D., University of California
- Hagen-Smith, Robin G. (1984)
Senior Instructor, Physical Education
Center for Teacher Education
B.S., Rio Grande College
M.Ed., Xavier University
- Hamilton, Virginia M. (1987)
Associate Professor, Mathematics
College of Arts and Sciences
B.A., M.S., Ball State University
- Hanlon, William J. (1988)
Assistant Professor, Data Processing
College of Business
B.S., University of Pittsburgh
M.B.A., Cleveland State University
- Herrmann, Sibylle R. (1969)
Associate Professor, Biological Sciences
College of Arts and Sciences
B.S., Ohio University
M.S., University of Michigan
- Hilgarth, Carl O. (1990)
Assistant Professor, Electrical and Computer
Engineering Technology
College of Engineering Technologies
B.S., The City College of New York
M.S., University of Missouri-Rolla
- Hodgden, Betty J. (1975)
Associate Professor, English
College of Arts and Sciences
B.A., Otterbein College
M.A., Marshall University
- Holt, Jerry G. (1990)
Chairperson, Professor
Department of Arts and Humanities
College of Arts and Sciences
B.S., Oklahoma State University
M.A., Ph.D., University of Oklahoma
- Huang, Xiaodan (1993)¹
Assistant Professor, Education
Center for Teacher Education
B.A., Nanchang Teachers College
M.Ed., St. Bonaventure University
Ph.D., Cornell University
- Humble, Jeffery S. (1989)
Senior Instructor, Plastics Engineering
Technology
College of Engineering Technologies
B.S., Ball State University
- Irwin, C. Ray (1971)
Associate Professor, Electromechanical
Engineering Technology
College of Engineering Technologies
B.S.E.E., M.Ed., Ohio University
- James, Jack E. (1973)
Professor, Psychology/Sociology
College of Arts and Sciences
B.A., Houghton College
M.S., Alfred University
M.Div., Colgate Rochester Divinity School
- Jenkins, Loretta J. (1982)
Assistant Professor, Accounting
College of Business
A.A.B., Shawnee State Community College
B.B.A., M.Ed., Ohio University

¹ Pending Board of Trustees approval

Kegley, Phyllis C. (1974)
Associate Professor, Mathematics
College of Arts and Sciences
B.S., The Ohio State University
M.A., Marshall University

Kelley, John L. (1969)
Associate Professor, History/Political Science
College of Arts and Sciences
B.A., Marian College
M.A., Indiana University

Kiser, Joyce A. (1972)
Associate Professor, Office Administration
College of Business
B.A., M.B.E., Morehead State University

Kiser, Shannon N. (1972)
Associate Professor, English
College of Arts and Sciences
B.A., Morehead State University
M.A., University of Kentucky

Kosan, Julius Ted (1990)
Senior Instructor, Electrical and Computer
Engineering Technology
College of Engineering Technologies
B.S., M.S., Bowling Green State University

Lawson, Patricia Ann (1986)
Chairperson, Senior Instructor
Physical Therapist Assistant Program
College of Health Sciences
B.S., University of Kansas

Lawson, Robert A. (1992)
Assistant Professor, Economics
College of Arts and Sciences
B.S., Ohio University
M.S., Ph.D., Florida State University

Leedom, Wm. Patric (1993)¹
Assistant Professor, Education
Center for Teacher Education
B.A., San Francisco State University
M.Ed., Xavier University
Ed.D., University of Cincinnati

Leeds, Marc A. (1989)
Associate Professor, English
College of Arts and Sciences
B.A., Brooklyn College
M.A., New York University
Ph.D., SUNY at Buffalo

Li, Jinlu (1989)
Associate Professor, Mathematics
College of Arts and Sciences
B.S., Beijing University
Ph.D., Wayne State University

Lonney, Larry W. (1989)
Assistant Professor, Physics
College of Arts and Sciences
B.S., Illinois State University
M.S., Purdue University
Ph.D., Washington State University

Lorentz, John H. (1990)
Associate Professor, History
College of Arts and Sciences
B.A., Miami University
M.A., Harvard University
Ph.D., Princeton University

Marouf, Mousa S. (1989)
Leave of Absence
Assistant Professor, Mathematics
College of Arts and Sciences
B.S., University of Alexandria
M.S., Ball State University
Ph.D., Kent State University

Marsh, Eleanor A. (1976)
Associate Professor, Sociology/Anthropology
College of Arts and Sciences
B.A., Washington State College
M.A., Washington State University
M.B.A., Ohio University

Massie, Gayle D. (1982)
Assistant Professor, Associate Degree Nursing
College of Health Sciences
B.S.N., Spalding University
M.S.N., University of Tennessee

Miller, James M. (1989)
Chairperson, Assistant Professor
Department of Social Sciences
College of Arts and Sciences
B.S., Manchester College
Ph.D., Kent State University

Miner, Edward C. (1983)
Associate Professor, Sociology/Psychology
College of Arts and Sciences
B.A., Youngstown State University
M.A., Kent State University
Ph.D., Kent State University and Akron
University

Mirabello, Mark L. (1987)
Associate Professor, History
College of Arts and Sciences
B.A., University of Toledo
M.A., University of Virginia
Ph.D., University of Glasgow (Scotland)

Montavon, Melinda D. (1988)
Instructor, Occupational Therapy Assistant
College of Health Sciences
A.A.S., Shawnee State Community College

Moore, Dan M. (1988)
Associate Professor, Management
College of Business
B.S., University of Virginia
M.B.A., D.B.A., Georgia State University

Mullens, Barbara S. (1980)
Associate Professor, Dental Hygiene
College of Health Sciences
A.A.S., Scioto Technical College
B.S., M.Ed., Ohio University

Murray, Nancy L. (1992)
Instructor, Dental Hygiene
College of Health Sciences
B.S., The Ohio State University

¹ Pending Board of Trustees approval

- Nickel, Linda K. (1978)
Associate Professor, Dental Hygiene
College of Health Sciences
A.A.S., Scioto Technical College
B.S., M.Ed., Ohio University
- O'Connor, Christopher S. (1992)
Assistant Professor, Mathematics
College of Arts and Sciences
B.A., University of California at Santa Cruz
M.S., San Jose State University
Ph.D., University of Oregon
- Oliver, Scott D. (1976)
Professor, Biological Sciences
College of Arts and Sciences
D.D.S., M.S., The Ohio State University
- Osborne, Dane H. (1988)
Assistant Professor, Physical Therapist
Assistant Program
College of Health Sciences
B.S., The Ohio State University
M.Ed., Ohio University
- Pambookian, Hagop S. (1987)
Professor, Psychology
College of Arts and Sciences
B.A., American University of Beirut
M.A., Columbia University
Ph.D., University of Michigan
- Penn, William H. (1977)
Associate Professor, Computer Aided Drafting
and Design
College of Engineering Technologies
B.S.A.S., Miami University
M.Ed., Ohio University
- Perry, Catherine O. (1990)
Chairperson, Assistant Professor
Occupational Therapy Assistant Program
College of Health Sciences
B.S., The Ohio State University
M.Ed., University of North Carolina
- Priode, Carl E. (1985)
Senior Instructor, Electromechanical Engineer-
ing Technology
College of Engineering Technologies
B.S.E.T., Franklin University
- Raiser, Lane C. (1989)
Assistant Professor, Art
College of Arts and Sciences
B.A., Kutztown State College
M.F.A., Brooklyn College
- Renfroe, Brenda S. (1991)
Senior Instructor, Radiologic Technology
College of Health Sciences
A.A.S., B.U.S., Morehead State University
- Ruby, Jerry L. (1988)
Associate Professor, Finance
College of Business
B.B.A., Ohio University
M.B.A., Morehead State University
- Rudolph, Brian A. (1991)
Assistant Professor, Electrical and Computer
Engineering Technology
College of Engineering Technologies
A.A.B., Firelands College
B.S., M.S., Bowling Green State University
- Scherer, Roger C. (1991)
Associate Professor, Plastics
College of Engineering Technologies
B.S., California State Polytechnic University
M.A., California State University
- Schott, Kevin C. (1991)
Assistant Professor, Electrical and Computer
Engineering Technology
College of Engineering Technologies
B.S., M.S., Bowling Green State University
- Scott, Edmon N. (1978)
Assistant Professor, Instrumentation and Control
College of Engineering Technologies
B.S., Bowling Green State University
- Scott, Sharon M. (1978)
Associate Professor, Associate Degree Nursing
College of Health Sciences
A.D.N., B.S.N., M.Ed., Ohio University
M.S.N., Bellarmine College
- Sherman, Martha J. (1991)
Assistant Professor, Education
Center for Teacher Education
B.S., Missouri Western College
M.E., University of North Florida
Ph.D., Purdue University
- Simon, Kathleen M. (1971)
Professor, English
College of Arts and Sciences
B.A., M.A., Eastern Kentucky University
Ph.D., Ohio University
- Smith, Lyle B. (1975)
Assistant Professor, Plastics
College of Engineering Technologies
B.S., Ohio University
- Staton, Pamela J. (1988)
Chairperson, Associate Professor
Medical Laboratory Technology
College of Health Sciences
B.S., Morehead State University
M.S., West Virginia University
- Stead, Thomas D. (1969)
Associate Professor, Art
College of Arts and Sciences
B.F.A., M.F.A., Ohio University
- Strickland, Ted (1989)
Visiting Professor
College of Arts and Sciences
B.A., Asbury College
M.A., University of Kentucky
M.Div., Asbury Theological Seminary
Ph.D., University of Kentucky
- Strunk, Priscilla A. (Sunny) (1984)
Instructor, Respiratory Therapy
College of Health Sciences
A.A.S., Shawnee State University

Sykes, William W. (1981)
Chairperson, Associate Professor
Radiologic Technology
College of Health Sciences
A.A.S., Central Ohio Technical College
B.S., The Ohio State University
M.B.A., Xavier University

Thiel, Becky A. (1981)
Assistant Professor, Associate Degree Nursing
College of Health Sciences
B.S.N., The Ohio State University
M.S.N., University of Tennessee

Thomas, Donald L. (1986)
Chairperson, Associate Professor
Respiratory Therapy
College of Health Sciences
A.S., Kettering College of Medical Arts
B.S., Georgia State University

Thoroughman, Marla H. (1989)
Assistant Professor, Medical Laboratory
Technology
College of Health Sciences
MT (ASCP)
B.S., M.A., Morehead State University
M.S., Morehead State University

Todt, David E. (1978)
Associate Professor, Biological Sciences
College of Arts and Sciences
Coordinator, Project Discovery South Region
B.S., M.En.S., Miami University

Trampe, George M. (1977)
Associate Professor, Chemistry
College of Arts and Sciences
B.S., University of Illinois
Ph.D., Purdue University

Valentine, Eugene J. (1990)
Associate Professor, Community
Involvement/Philosophy
College of Arts and Sciences
A.B., Harvard University
M.A., Ph.D., Michigan State University

Walke, Jerry L. (1976)
Professor, Psychology
College of Arts and Sciences
B.S., Capital University
M.Ed., Ph.D., The Ohio State University

Walker, Marsha L. (1987)
Assistant Professor, Office Administration
College of Business
B.S., M.A., The Ohio State University

Waller, Betty M. (1968)
Associate Professor, Physical Education
Center for Teacher Education
B.S., Miami University
M.A., Marshall University

Ward, Carol M. (1992)
Assistant Professor, Associate Degree Nursing
College of Health Sciences
B.S.N., Western Reserve University
M.S.N., Case Western Reserve University

Warfield, Kenneth W. (1983)
Senior Instructor, Electromechanical Engineer-
ing Technology
College of Engineering Technologies
B.G.S., Ohio University

Waterman, Deborah A. (1991)
Assistant Professor, Legal Assisting Technology
College of Business
B.A., The College of William and Mary
J.D., The Ohio State University

Wilson, Robert L. (1978)
Professor, English
College of Arts and Sciences
B.S., Kent State University
M.Ed., Xavier University
Ph.D., Florida State University

Yang, Zhanbo (1989)
Associate Professor, Mathematics
College of Arts and Sciences
B.S., M.S., Heilongjing University
Ph.D., Auburn University

Yost, Carlson W. (1987)
Associate Professor, English
College of Arts and Sciences
B.S., Cornell University
B.A., Utica College of Syracuse University
M.A., Ph.D., Texas A & M University

Yun, C.H. (Nan) (1988)
Professor, English
College of Arts and Sciences
B.A., San Francisco State University
M.A., University of Chicago
Ph.D., Syracuse University



Please print or type all information and answer all questions. Be sure to sign your name and date the application on the reverse side. Applications which are incomplete will be returned, which may result in a delay in acceptance for admission. Your application should be accompanied by the current non-refundable application fee. Please do not send cash.

Freshman Applicants

An official high school transcript must be forwarded to the Office of Admission directly from the high school. Transcripts mailed with the application or those which are hand carried are not accepted.

For applicants who did not complete high school but have earned high school equivalency through the GED (General Education Development) program, an official GED transcript should be requested from the Department of Education of the state in which the test was taken. Request forms for the GED and the address of the Departments of Education in Ohio and Kentucky are available in the Office of Admission.

All degree-seeking students under the age of 21 must provide their ACT scores. Since Shawnee State University is an open admission university, the ACT is not used to make an admission decision.¹ It may, however, be used to assist in academic advising and registration. Students who have not taken the ACT may be accepted provisionally, but must take the ACT during their initial quarter of enrollment at Shawnee State.

Transfer Students

In addition to the application for admission and application fee, transfer applicants must forward an official high school transcript and official transcripts from all other colleges and universities attended. Transfer students who have earned fewer than 45 quarter hours (30 semester hours) at previous schools and are under age 21 must submit ACT scores (or take the ACT during the initial quarter of enrollment).

Non-Degree Students

Applicants who wish to take courses for reasons other than earning a degree (e.g., self-enrichment, work-related courses, coursework for transfer to another college) need not provide high school or college transcripts. They may however, be required to provide transcripts or grade cards to take courses which have prerequisites.

International Students

Applicants who are not citizens of the United States must meet special admission requirements. For an international student application and admission packet, please write the International Student Advisor, Office of Admission, Shawnee State University, 940 Second Street, Portsmouth, Ohio 45662.

¹ The American College Test (ACT) is required of all applicants for admission to some of the health sciences programs. Specific information about required scores is stated in that section of the catalog.



Shawnee State University
Portsmouth, Ohio 45662

Application for Admission

Please complete this application and return it to the Office of Admission at Shawnee State University. Also include the non-refundable \$30¹ application fee and have your high school transcript sent directly from the school to Shawnee State University or GED transcript directly from the State Department of Education. If you have attended another college or university, the registrar from that institution must forward an official college transcript to the Office of Admission at Shawnee State.

Personal Data

Name: _____
Last First Middle/Former

Local Address: _____
Number & Street City State Zip Code County

Permanent or Parents' Address: _____
Number & Street City State Zip Code County

Place of Birth: _____ Date of Birth: _____
State County

Home Phone: () _____ Social Security Number: _____

High School Attended: _____ Grad. Date: _____ GED: _____
Date Received

High School Location: _____ ACT/CEEB Code: _____
City State County

Resident Status for Past 12 Months:

- 10—Resident of Scioto County
- 1—Resident of Ohio, not Scioto County
- 6—Resident of Mason, Lewis, Boyd, or Greenup Counties, Kentucky or Cabell or Wayne Counties, West Virginia
- 2—Resident of another state: _____
County _____
- 3—Other National
- 4—Foreign: Visa Type _____

Housing/Living Arrangements:

- 1—Commuter (drive from home)
- 2—On-Campus Housing
- 4—Other

The information requested in the shaded area, while voluntary in nature, is necessary for state and national purposes. Your completion of this area is appreciated.

Gender: Male Female
 Marital Status:
 (1) Married (2) Single (3) Divorced (4) Widowed
 Race/Ethnic:
 1—Afro-American/Black
 2—American Indian or Alaskan
 3—Asian or Pacific Islander
 4—Hispanic
 5—Caucasian/White
 Voluntary Disclosure:
 Do you want to claim a disability? Yes No
 Do you want to claim learning disabled status? Yes No
 Type of disability: _____

Have you previously applied to Shawnee State University? Yes No

Have you attended other colleges/universities? Yes No List all colleges/universities attended previously:

_____ Date attended: _____ to _____
 _____ Date attended: _____ to _____

Were you, or will you be, in good academic standing when you transfer? (2.00 G.P.A. minimum) Yes No

Are you in good financial standing with all college/university previously attended? (Do you owe money to a college or university?) Yes No

Degree(s) earned: _____

Did you receive financial aid? Yes No

Are you a veteran? Yes No Did you receive veteran's benefits? Yes No

Student Intent in Enrolling

Degree

- A. Earn an Associate Degree (2-year degree)
 - Within 3 years In more than 3 years
- B. Earn a Bachelor's Degree (4-year degree)
 - Within 6 years In more than 6 years
- C. Earn a one-year certificate

Non-Degree

- D. Gain qualifications and skills for employment
- E. Take coursework for personal enrichment
- F. Complete coursework for transfer to another institution
- G. Earn Teacher Certification only (bachelor's degree earned previously)

¹ This is a 1993-94 fee and is subject to change.

² Shawnee State University does not discriminate in admission, access, or treatment in programs and activities or employment policies or practices on the basis of race, creed, sex, color, national or ethnic origin, religion, marital status, age, sexual orientation, or qualified handicap.

I am making application for the following major:

College of Arts and Sciences

Bachelor Degrees

- 41400 English/Humanities—General
 - 41401 Elementary Education
- 51400 Applied Mathematics
 - 51401 Elementary Education
- 61400 Natural Science
 - 61403 Chemistry
 - 61404 Environmental Science
 - 61405 Life Science
 - 61406 Natural Science/Physical Science
 - 61407 Pre-Medicine
 - 61408 Pre-Veterinary
 - 61401 Elementary Education
- 71400 Social Science
 - 71402 History
 - 71403 Pre-Law
 - 71404 Psychology
 - 71405 Sociology
 - 71401 Elementary Education

Associate Degrees

- 41200 Arts/Humanities—General
 - 41201 Art
 - 41202 Communications
 - 41204 English
 - 41206 Music
- 51200 Mathematics
- 61200 Natural Science
 - 61201 Botany
 - 61202 Chemistry
 - 61204 Physics
- 71200 Social Science
 - 71201 Government
 - 71202 History
 - 71204 Psychology
 - 71205 Sociology

College of Business

Bachelor Degrees

- 11400 Business Administration/General

Associate Degrees

- 12201 Accounting/Professional
- 12202 Accounting/Management
- 11201 Business Management/Management
- 11202 Banking & Finance
- 11203 Real Estate
- 11204 Retail
- 11205 Small Business¹
- 13200 Computer Information Systems in Business
- 14200 Office Administration
- 15200 Legal Assisting

College of Engineering Technologies

Bachelor Degrees

- 31400 Electrical & Computer Engineer. Tech.
- 32400 Plastics Engineering Technology

Associate Degrees

- 32200 Plastics Engineering Technology
- 33200 Electromechanical Engineering Technology
 - 33301 Robotics
- 34200 Instrumentation and Control Eng. Tech.
 - 34301 Robotics
- 35200 Computer Aided Drafting and Design

Certificate

- 35100 Computer Aided Drafting and Design

College of Health Sciences

Bachelor Degrees

- 11401 Health Management¹

Associate Degrees

- 21200 Dental Hygiene
- 22200 Associate Degree Nursing
- 23200 Medical Laboratory Technology
- 24200 Occupational Therapy Assistant
- 25200 Physical Therapist Assistant
- 26200 Radiologic Technology
- 27200 Respiratory Therapy
- 28200 Emergency Medical Technology¹

Center for Teacher Education

- 41401 English/Humanities—Elementary Education
- 51501 Mathematics—Elementary Education
- 61401 Natural Science—Elementary Education
- 71401 Social Science—Elementary Education
- 00401 Teacher Certification Only (Bachelor's degree earned previously)

Other

- 00001 Undecided
- 01200 Associate of Individualized Studies
- 00000 Special, Non-Degree
- 88888 GED
- Current High School Student

QUARTER AND YEAR YOU PLAN TO ATTEND:

- Fall Winter Spring Summer Yr. _____

Name and Address of Hometown Newspaper: _____

How did you hear about Shawnee State University? _____

I certify that the statements included in this application are accurate and true to the best of my knowledge. Any falsification of information may result in disciplinary action including dismissal.

Signature of Applicant

Date

MAILING ADDRESS: Please return the completed application and a non-refundable \$30² check or money order made payable to Shawnee State University to the Office of Admission, Shawnee State University, 940 Second Street, Portsmouth, Ohio 45662-4303.

¹ Pending approval

² This is a 1993-94 fee and is subject to change.

- Academic Assessment, 27
 Academic Calendar, 10-15
 Academic Dismissal, 38
 Academic Integrity, 35
 Academic Policies, 35-41
 Academic Probation, 38
 Accounting Technology, 86-88
 curriculum, 87-88
 Accreditations and Approvals
 associate degree nursing, 9, 132
 dental hygiene, 9, 134
 emergency care educational programs, 9,
 49, 136
 medical laboratory, 9, 139
 occupational therapy (associate degree),
 9, 141
 occupational therapy (bachelor's degree),
 125
 physical therapist, 9, 143
 radiologic technology, 9, 144
 respiratory therapy, 9, 146
 university, of the, 9
 Adding a Class, 41
 Administration, 232-234
 Administrative Hold, 36
 Admission Requirements, 16-26, 125,
 129-131
 academically advanced high school stu-
 dents, 24-26
 applicants with GED, 17
 degree and certificate students, 16
 health sciences students, 129-131
 international students, 22, 23
 recent high school graduates, 16, 17
 senior citizens, 24
 special, non-degree students, 23
 transfer students, 17-22
 transient students, 23
 undeclared major/undecided students, 17
 Advanced Placement, 17
 Advising, 40, 59
 Appeal Procedure, Transfer Credit, 21, 22
 Appealing Dismissal from Health Sciences
 Programs, 131, 132
 Applicants with GED, 17
 Application, 25, 31, 240, 241, 242
 financial aid, 31
 form, 241, 242
 high school students, 25
 instructions, 240
 Application Fee, 29, 31, 241, 242
 Applied Mathematics, 67-69
 Articulation and Transfer, State Policy, 18,
 19
 Arts and Sciences, College of, 57-80
 academic advising, 59
 arts and humanities, department of, 61-66
 associate degree requirements, 60
 baccalaureate degree requirements, 60
 course scheduling and offerings, 60
 degrees offered, 56, 58, 59
 faculty, 59
 mathematics, department of, 67-70
 minors, 60
 mission of the college, 58
 natural sciences, department of, 71-75
 pass/no credit policy, 60
 preparation for elementary education
 certification, 60
 selecting and declaring a degree major,
 59
 social sciences, department of, 76-80
 telephone number, 6
 Arts Degree, Associate of, 65, 66, 78, 79
 Arts and Humanities, Department of,
 61-66
 academic advising, 40, 59
 associate degrees, 65, 66
 bachelor of arts, major in English/
 Humanities, 61-64
 degrees offered, 56
 elementary education certification, 64, 65
 mission of the department, 61
 telephone number, 6
 Associate Degree Nursing, 132, 133
 accreditation, 132
 admission requirements, 129-131
 curriculum, 133
 guidelines for appealing dismissal, 131,
 132
 Associate of Applied Business, Accounting,
 86-88
 Associate of Applied Business, Business
 Management, 89-92
 Associate of Applied Business, Computer
 Information Systems in Business, 92-94
 Associate of Applied Business, Legal Assist-
 ing, 95, 96
 Associate of Applied Business, Office
 Administration Technology, 94, 95
 Associate of Applied Science, Associate
 Degree Nursing, 132, 133
 Associate of Applied Science, Computer
 Aided Design, 107-109
 Associate of Applied Science, Dental Hygiene,
 133-135
 Associate of Applied Science, Electro-
 mechanical Engineering Technology,
 109-111
 Associate of Applied Science, Emergency
 Medical Technology, 135-138
 Associate of Applied Science, Instrumentation
 and Control Engineering Technology,
 111-113
 Associate of Applied Science, Medical
 Laboratory Technology, 138-140
 Associate of Applied Science, Occupa-
 tional Therapy Assistant, 140-142
 Associate of Applied Science, Physical
 Therapist Assistant, 143, 144
 Associate of Applied Science, Plastics
 Engineering Technology, 113-115



- Associate of Applied Science, Radiologic Technology, 144-146
- Associate of Applied Science, Respiratory Therapy, 146-148
- Associate of Arts, Humanities Concentration, 65, 66
- Associate of Arts, Social Science Concentration, 78, 79
- Associate of Individualized Studies, 66, 70, 75, 79, 96, 119, 148
- Associate of Science, Mathematics Concentration, 69, 70
- Associate of Science, Natural Science Concentration, 74, 75
- Athletics, Intercollegiate, 45, 46
- Athletics, Intramural, 46
- Attendance, 40
- Audit, 38
- Bachelor of Applied Science, Concentration in Health Management, 122-124
- Bachelor of Arts, Major in English/Humanities, 61-64
 elementary education certification, 64, 65, 153, 154
- Bachelor of Arts, Major in Social Science, 76, 77
 elementary education certification, 77, 155, 156
 2 + 2 legal assisting program, 77, 78
- Bachelor of Science in Business Administration, Major in General Business, 82-86
- Bachelor of Science in Electrical and Computer Engineering Technology, 99-103
- Bachelor of Science in Natural Science, 71, 72
 elementary education certification, 72, 73, 154, 155
- Bachelor of Science in Natural Science, Concentration in Applied Mathematics, 67
 elementary education certification, 68, 69, 154
- Bachelor of Science in Occupational Therapy, 124-129
- Bachelor of Science in Plastics Engineering Technology, 104-107
- Bad Check Policy, 30
- Banking and Finance, 90, 91
- Board of Trustees, 232
- Bookstore, 47
- Budget Payment Plan, 30
- Business, College of, 81-96
 accounting technology, 86-88
 associate degree in applied business, 86-96
 associate of individualized studies degree, 96
 bachelor of science in business administration, 82-86
 banking and finance, 90, 91
 business management, 89-91
 computer information systems in business, 92-94
 degrees offered, 56, 82
 governmental accounting, 87
 legal assisting, 95, 96
 management accounting, 87
 mission of the college, 82
 office administration, 94, 95
 public accounting and the CPA, 87
 real estate, 91, 92
 retail management, 90
 small business management, 92
 telephone number, 6
- Business Management Technology, 89-92
- CADD Certificate Program, 115
- CADD Sequence, 108
- Calendar, 10-15
- Career Services, 43
- Celeron Square, 48
- Center for Business and Industry, 49
- Center for Integrative Studies, 52
- Center for Teacher Education, 149-156
 certification requirements, 150
 course scheduling, 151
 curriculum, 151-156
 degree requirements, 152
 elementary education certification, 150
 eligibility criteria, 151
 English/Humanities Major, 153, 154
 health, physical education, and recreation, 152, 153
 mathematics major, 154
 mission of the center, 150
 natural science major, 154, 155
 pass/no credit policy, 151
 social science major, 155, 156
 telephone number, 6
- Certificate in Computer Aided Drafting and Design, 115, 116
- Certificate in Environmental Science, 73
- Certificate in Plastics Engineering Technology, 116, 117
- Changing Grades, 38
- Children at the University, 40
- Class Ranking, 35, 36
- College Level Examination Program (CLEP), 37
- College Work Study, 33
- Communication with the University, 6
- Computer Aided Design, 107-109
 CADD electives, 107
 CADD sequence, 108
 curriculum, 108, 109
 technical electives, 107
- Computer Aided Drafting and Design Certificate, Technician Program, 115, 116
 curriculum, 116
- Computer Information Systems in Business, 92-94
 curriculum, 93,94

- Concentration, Biomedical Instrumentation, 112, 113
- Connection, The, 44
- Continuing Education, 48-50
center for business and industry, 49
emergency care educational programs, 49, 50
mission of continuing education, 49
special programs and community services, 49
- Counseling, 42-44
- Counseling and Career Services, Office of, 42, 43
- Counseling and Assessment, 42
- Course Descriptions, 157-231
explanation of abbreviations, 157
explanation of prerequisites, 157
- Credit by Arrangement, 38, 39
- Credit by Examination, 37
- Credit for Military Educational Experiences, 37
- Dean's List, 36
- Dental Hygiene, 133-135
academic requirements, 134
accreditation, 134
admission requirements, 129-131
curriculum, 134, 135
guidelines for appealing dismissal, 131, 132
job opportunities, 134
- Developmental Education, 44, 45
developmental courses, 45
- Disability Services, 43
- Dismissal, 38
- Education, Elementary, 60, 64, 65, 68, 69, 72, 73, 77, 149-156
English/Humanities, 64, 65
mathematics, 68, 69
natural science, 72, 73
social science, 77
- Electrical and Computer Engineering Technology, 99-103
curriculum, 102, 103
degree requirements, 100-102
- Electromechanical Engineering Technology, 109-111
curriculum, 110-111
robotics major option, 111
- Emergency Care Educational Programs, 49, 50
accreditation, 49
enrollment information, 50
entrance requirements, 50
levels of training, 49, 50
related course offerings, 50
- Emergency Medical Technology, 135-138
academic requirements, 136
accreditation, 136
approved electives, 138
curriculum, 137, 138
entrance requirements, 129-131, 136, 137
- Employment, Student, 33, 34
- Enduring Vision Statements, 8, 9
- Engineering Technologies, College of, 97-120
associate of applied science, computer aided design, 107-109
associate of applied science, electro-mechanical engineering technology, 109-111
associate of applied science, instrumentation and control engineering technology, 111-113
associate of applied science, plastics engineering technology, 113-115
associate of individualized studies, 119
bachelor of science, electrical and computer engineering technology, 99-103
bachelor of science, plastics engineering technology, 104-107
CADD sequence, 108
certificate, computer aided drafting and design, 115, 116
certificate, plastics engineering technology, 116, 117
concentration, biomedical instrumentation, 112, 113
course scheduling, 102, 105, 108, 110, 111, 114, 115
degrees offered, 56, 98
engineering technology programs at Shawnee State, 99
minor, computer technology, 117-119
minor, plastics engineering technology, 117
mission of the college, 98
pass/no credit policy, 99
pre-engineering curriculum, 119, 120
robotics major option, 111, 113
telephone number, 6
- Faculty, 234-239
- Faculty Advising, 40, 59
- Faculty Expectations and Responsibilities, 40
- Fees, 29-31, 37, 41
application, 29, 31
change order, 29, 31
credit by arrangement, 29
credit by examination, 29, 37
educational clinical, 29
full-time students, 29
general, 29
graduation, 29, 31
graduation reapplication, 29
health science, 29
lab fees, 29, 30
late payment, 29, 31
late registration, 29, 31
out-of-state, 29
out-of-state district, 29
parking, 29, 30
part-time students, 29
refund of, 30
transcript, 29, 31, 41

- transcript, immediate action, 29, 31
- Financial Aid, 31-35
 application procedure, 31
 award disbursements, 32
 deadline for application, 31
 determining need, 32
 eligibility requirements, 34
 employment, 33, 34
 grants, 32
 loans, 33
 notification, 32
 satisfactory academic progress, 34, 35
 scholarships, 32
 veterans' benefits, 34
 work study, 33
- Freshman Applicants, 240
- GED, Applicants with, 17
- General Education Core, 52-55
 courses, 55
- Goals of the University, 8
- Governmental Accounting, 87
- Grade Point Ratio, 38
- Grade Reports, 41
- Grading/Awarding of Credit, 35
- Graduate Realtors Institute, 92
- Graduation Requirements, 41
 fee, 29, 31
- Graduation with Honors, 41, 42
- Graduation/Persistence Rates, 42
- Grants, 32
- Health Sciences, College of, 121-148
 admission requirements, 125, 129-131
 appealing dismissal, 131, 132
 associate degree nursing, 132, 133
 associate of individualized studies, 148
 bachelor of applied science in health management, 122-124
 bachelor of science in occupational therapy, 124-129
 degrees offered, 56, 122
 dental hygiene, 133-135
 emergency medical technology, 135-138
 health science class schedule, 131
 medical laboratory technology, 138-140
 mission of the college, 122
 pass/no credit policy, 131
 occupational therapy assistant, 140-142
 physical therapist assistant, 143, 144
 radiologic technology, 144-146
 respiratory therapy, 146-148
 telephone number, 6
- High School Students, 24-26
- History of the University, 7
- Honors, Graduation, 41
- Honors Program, 39
- Housing, 48
- Identification Cards, 47
- Improper Registration, 27
- Incomplete Grades, 36
- Individualized Studies Degree, Associate of, 66, 70, 75, 79, 96, 118, 148
- Instrumentation and Control Engineering Technology, 111-113
 curriculum, 112
 biomedical instrumentation concentration, 112
 robotics major option, 113
- Insurance, Student, 30
- International Students, 22, 23, 43, 240
 support services, 43
- International Study Programs, 39, 40
- Internship Guidelines, 39
- JOBS Student Retention Program, 44
- Late Payment, 29, 31
- Late Registration, 29, 31
- Learning Center, 45
- Legal Assisting
 associate degree, 95, 96
 bachelor of arts degree (2 + 2), 77, 78
- Library, 47
- Loans, 33
- Mailing Address, 6
- Management Accounting, 87
- Mathematics, Department of, 67-70
 academic advising, 40, 59
 associate degrees, 69, 70
 bachelor of science in natural science, 67
 degrees offered, 56
 elementary education certification, 68, 69
 mathematics at Shawnee State University, 67, 68
 mathematics sequence, 68
 mission of the department, 67
 telephone number, 6
- Medical Laboratory Technology, 138-140
 academic requirements, 139
 accreditation, 139
 admission requirements, 129-131
 certification, 139
 curriculum, 139, 140
 employment opportunities, 139
 guidelines for appealing dismissal, 131, 132
 scholarships, 139
- Military Educational Experience, Credit for, 37
- Minor in Computer Technology, 117-119
- Minor in Environmental Science, 73, 74
- Minor in Plastics Engineering Technology, 117
- Minority Affairs, 43
- Mission Statement
 arts and humanities, department of, 61
 arts and sciences, college of, 58
 business, college of, 82
 continuing education, 49
 engineering technologies, college of, 98
 health sciences, college of, 122
 mathematics, department of, 67
 natural sciences, department of, 71
 social sciences, department of, 76
 university, of the, 7
- Music courses, 212, 213

- National Association of Intercollegiate Athletics (N.A.I.A.), 46
- Natural Sciences, Department of, 71-75
 academic advising, 40, 59
 associate degrees, 74, 75
 bachelor of science in natural science, 71, 72
 certificate, environmental science, 73
 degrees offered, 56
 elementary education certification, 72, 73
 minor, environmental science, 73, 74
 mission of the department, 71
 telephone number, 6
- Non-Credit, 38
- Non-Degree Students, 23-26, 240
- Nursing, 132, 133
- Occupational Therapy Assistant, 140-142
 academic requirements, 141
 accreditation, 141
 admission requirements, 129-131
 clinical requirements, 141
 curriculum, 142
 guidelines for appealing dismissal, 131, 132
- Office Administration Technology, 94, 95
 curriculum, 94, 95
 previous typing training, 94
- Ohio Instructional Grant, 32
- Ohio Technology Transfer Organization (OTTO), 49
- Orientation, 26, 27
- Paramedic Program, 49, 50
- Pass/No Credit Policy, 36, 37, 60, 99, 131, 151
- Pell Grant, 32
- Pep Band, 47
- Physical Therapist Assistant, 143, 144
 accreditation, 143
 admission requirements, 129-131
 curriculum, 143, 144
 guidelines for appealing dismissal, 131, 132
- Placement, 42, 43
- Placement Testing, 27, 182
- Plastics Engineering Technology
 associate of applied science, 113, 114
 curriculum, 114
 bachelor of science, 104-107
 curriculum, 105-107
 degree requirements, 104, 105
 minor in, 116
 one-year certificate, 116
- Postsecondary Enrollment Options Program, 24-26
 acceptance, notification, and reporting, 26
 application, 25
 college credit (Option A), 24
 eligibility, 24
 freshmen and sophomores, 26
 high school credit (Option B), 24, 25
 juniors and seniors, 24
 program continuation, 26
 registration, 25, 26
 validation of credit, 26
- Pre-engineering Curriculum, 119, 120
- Prerequisites, 37, 157, 181
- President's List, 36
- Probation, Academic, 38
- Programs of Study at Shawnee State, 56
- Project Discovery, 51
- Public Accounting and the CPA, 87
- Radiologic Technology, 144-146
 academic requirements, 144, 145
 accreditation, 144
 admission requirements, 129-131
 curriculum, 145, 146
 guidelines for appealing dismissal, 131, 132
- Real Estate, 91, 92
- Refund of Fees, 30
- Registration, 27, 28
 high school students, 25
 improper, 27
 residency information, 28
 selective service, 27
- Repeating Coursework, 38
- Residency Information, 28
- Respiratory Therapy, 146-148
 academic requirements, 147
 accreditation, 146
 admission requirements, 129-131
 certification, 146
 curriculum, 147, 148
 employment opportunities, 147
 guidelines for appealing dismissal, 131, 132
- Retail Management, 90
- Robotics, 111, 113
- Satisfactory Academic Progress, 34, 35
- Scholarships, 32
- Science (*See Natural Sciences, Department of*)
- Science Degree, Associate of, 69, 70, 74, 75
- Secretarial (*See Office Administration Technology*)
- Selective Service Registration, 27, 28
- Senior Citizens, 24
- Social Sciences, Department of, 76-80
 academic advising, 40, 59
 associate degrees, 78-80
 bachelor of arts degree, major in social science, 76, 77
 degree requirements, 77
 degrees offered, 56
 elementary education certification, 77
 legal assisting (2 + 2), 77, 78
 mission of the department, 76
 telephone number, 6
- Special Fees, 29
- Special Programs and Community Service, 49

  
Index

- Staff, 232-239
State Policy on Articulation and Transfer,
18
Student Activities, 46, 47
Student Life Transcript Program, 46, 47
Student Load, 29
Student Loan Fund, 33
Student Support Services, 43
Supplemental Education Opportunity
Grant, 32
Tech Prep Ohio South Consortium, 51
Telephone Directory, 6
Test of English as a Second Language
(TOEFL), 22
Transcripts, 41
Transfer of Credit, 18-22
 appeal procedure, 21, 22
Transfer Module, 20
Transfer Placement, 44
Transfer Students, 17-22, 240
Transfer/University Parallel Programs, 44
Transient Students, 23
Trustees and Staff of Shawnee State,
232-239
Tuition and Fees, 29-31
Tutoring 43, 45
Undeclared Major/Undecided Student, 17
University Center, 47, 48
Upward Bound, 51
Veterans' Benefits, 34
Visitors to Class, 40
Welcome, 5
Withdrawal from the University, 41
Withdrawing from Class, 41
Women's Programs, 43, 44
Work Study, 33
- 
- 
- 

How to get to Shawnee State . . .

. . . from Cincinnati

Take Rt. 32 East to Rt. 23 South. Stay on Rt. 23 to Second Street in Portsmouth. Turn left on Second Street.

. . . from Dayton

Take Rt. 35 South to Rt. 23 South. Stay on Rt. 23 to Second Street in Portsmouth. Turn left on Second Street.

. . . from Columbus

Take Rt. 23 South to Second Street in Portsmouth. Turn left on Second Street.

. . . from Cleveland

Take Rt. 71 South to Rt. 23 South (Circleville exit). Take Rt. 23 South to Second Street in Portsmouth. Turn left on Second Street.

. . . from Toledo

Take Rt. 75 South to Rt. 23 South (Findlay). Take Rt. 23 South to Second Street in Portsmouth. Turn left on Second Street.

. . . from Kentucky

Take Rt. 23 North from Ashland across the U.S. Grant Bridge. Turn right on Second Street at the end of the bridge.

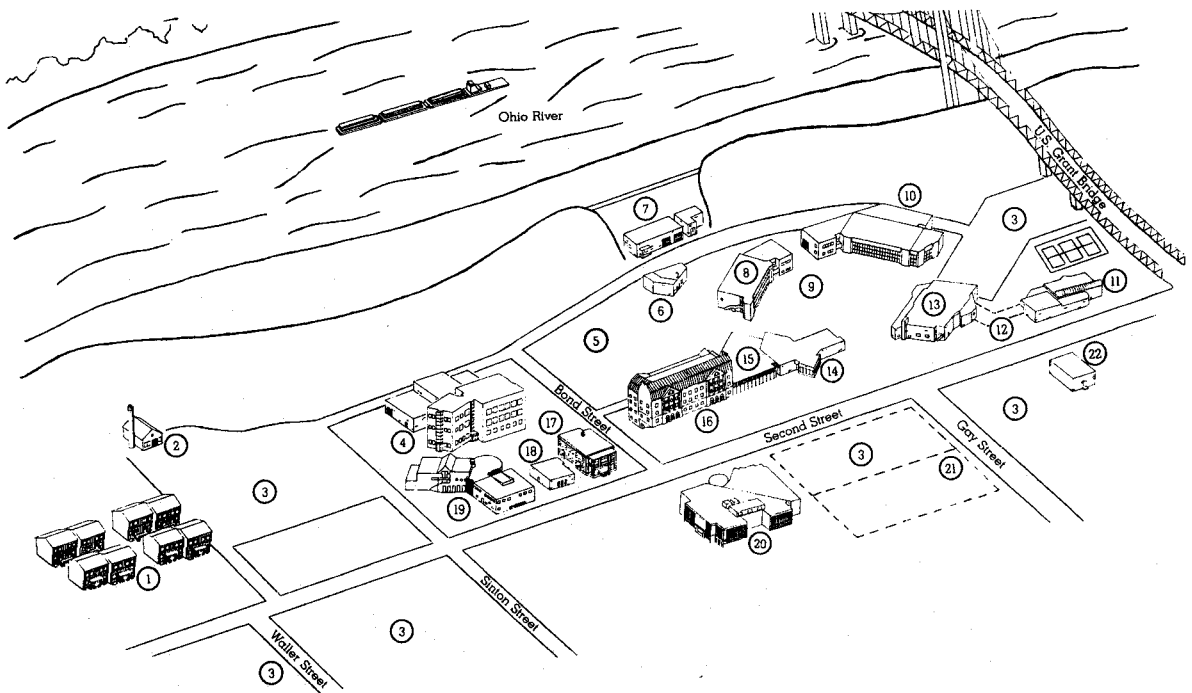

1. Celeron Square
2. Art Annex
3. Student Parking
4. Vern Riffe Advanced Technology Center
5. Faculty Parking
6. Maintenance/Security
7. Purchasing/Receiving
8. Business Building

9. Campus Green
10. Health Sciences Building
11. James A. Rhodes Sports Center
12. Future Site of the Indoor Physical Education Center Link
13. Activities Center
14. Commons Building
15. Business Annex

16. Massie Hall
17. 1004 Building
18. Bookstore
19. University Center
20. Library
21. Future Site of the Center for the Arts
22. Office Annex



Shawnee State University

910 East 10th St.

Delaware, Ohio 43015-1203

Office of Admission



Cover of book is included at cost