

Sharing
the
spirit!

SHAWNEE STATE

Shawnee State University
1997-99 Catalog

To learn more about
Shawnee State
University, call:

(614) 355-2221

or toll free at

1-800-959-2SSU

(admission questions)

or e-mail

admsn@shawnee.edu

or visit us on the world wide web

<http://www.shawnee.edu>

The Shawnee State University Catalog is
published biannually by Shawnee State
University, Portsmouth, Ohio

Non-profit rate—
Permit No. 93
Portsmouth, Ohio

Post Office Address:
Shawnee State University
940 Second Street
Portsmouth, Ohio 45662-4344

The Shawnee State University 1997-99 Catalog
was completely written and typeset on the
Shawnee State campus.

Shawnee State University does not discriminate in admission, access, or treatment in programs and activities or employment policies or practices on the basis of race, creed, sex, color, national or ethnic origin, religion, marital status, age, sexual orientation, Vietnam-era or qualified disabled veteran status, or qualified handicap. Accordingly, Shawnee State University complies with Title VI (34 C.F.R. Part 100) and Title VII of the Civil Rights Act of 1964, Title IX of the Education Amendments of 1972 (34 C.F.R. Part 106), the Age Discrimination in Employment Act of 1967, The Age Discrimination Act of 1975, the Equal Pay Act of 1963, Section 504 of the Rehabilitation Act of 1973 (34 C.F.R. Part 104), the Americans with Disabilities Act of 1990, and other appropriate state and federal statutes, regulations, and/or guidelines as they exist and may be amended from time to time. Inquiries regarding compliance with Title VI, Title IX, and Section 504 may be directed to the Affirmative Action Coordinator, located in the Office of the President, Commons Bldg., Shawnee State University, Portsmouth, OH 45662, telephone (614) 354-3205; to the Director, Ohio Civil Rights Commission, 220 Parsons Ave., Columbus, OH 43266; to the Director, Office for Civil Rights, U.S. Department of Education, Region V, 401 S. State St., Chicago, IL 60605; or to the Assistant Secretary for Civil Rights, U.S. Department of Education, Washington, D.C. 20202.



Sharing
the
Spirit!

SHAWNEE
STATE

To all new students

The requirements outlined in this catalog are the minimum you must meet for graduation under the current policies of Shawnee State University. These requirements are subject to change prior to graduation in order to comply with federal, state, and accreditation requirements. Shawnee State University reserves the right to make changes in its programs, policies, and procedures prior to your graduation which you will be required to meet unless specifically exempted from the changes.

- 3** **Welcome**
- 4** **How to Reach Us**
- 5** **About the University**
Past and Present • Mission Statement • Vision Statements • Accreditations and Approvals
- 9** **Academic Calendar**
1997-98 Academic Calendar • Tentative 1998-99 Academic Calendar
- 14** **Admission Policies**
*Degree-Seeking High School Graduates • Applicants with the GED • Undeclared Major/Undecided Student
• Transfer Students • International Students • Non-Degree Students • Campus Tours*
- 25** **Registration Information**
Registration • Orientation • Placement Testing • Student Advising and Referral Services • Supplemental Instruction
- 29** **Fees and Financial Aid**
Fees and Expenses • Financial Aid
- 37** **Academic Policies**
*Academic Integrity • Grading/Awarding of Credit • Class Ranking • Incomplete Grades • Administrative Hold
• Academic Assessment • Dean's List/President's List • Pass/No-Credit • Credit by Examination • College Level
Examination Program • Credit for Military Experiences • Prerequisites • Repeating Coursework • Changing Grades
• Grade Point Average • Academic Probation • Academic Dismissal • Non-Credit • Course Credit by Arrangement
• Honors Program • Internship Guidelines • International Study Programs • Faculty Advising • Faculty
Expectations and Responsibilities • Visitors to Class • Bringing Children to or Leaving Children at the University
• Adding a Class • Dropping a Class • Withdrawing from College • Transcripts/Grade Reports • Graduation
Requirements • Graduation with Honors • Developmental Education • Library • Continuing Education*
- 47** **Student Development**
*Counseling • Athletics • Student Activities • Bookstore • University Center • Housing and Residence Life
• Alumni Association*
- 53** **Academic Programs**
Programs of Study • General Education Program
- 58** **College of Arts and Sciences**
Arts and Humanities • Mathematical Sciences • Natural Sciences • Social Sciences • Teacher Education
- 101** **College of Professional Studies**
Business Administration • Health Sciences • Industrial and Engineering Technologies
- 150** **Outreach Programs**
*Talent Search • Tech Prep Ohio South Consortium • Upward Bound • Ohio Appalachian Center for Higher Education
• Ohio Appalachian Educational Opportunity Center • BEARS Program*
- 154** **Course Descriptions**
- 244** **Trustees and Staff**
- 252** **Index**

Greetings



President Veri welcomes honor students to his home for a cookout.

Shawnee State University is a special place!

We are a one-of-a-kind state university in Ohio because we are the only one that is dedicated to undergraduate education. Although many of our excellent faculty are involved in scholarship and creative activities, all of them have teaching as their primary focus, thus preparing our students for meaningful careers or graduate and professional schools.

Our tuition is kept low for you, the student. We want you to have access to the opportunities that a quality education provides. Low cost, combined with a small student body allows Shawnee State to serve as an alternative to small expensive colleges and to the larger state universities, which may not meet your personal needs.

At Shawnee State, faculty and staff take special pride in having had the opportunity to earn college degrees, and thereby enjoy satisfying and productive careers. All of us are eager to offer students the same chance we had. That's why, through Shawnee State, we now share our knowledge, skills, and experiences with people who wish to improve the quality of their lives through education. We call it "Sharing the Spirit of Opportunity."

We invite you to grab that "spirit" and run with it!

Sincerely yours,

Clive Veri, President

How to Reach Us

Mailing Address

Shawnee State University
940 Second Street
Portsmouth, Ohio 45662-4344

Telephone Number

(614) 354-3205

FAX Number

[614] 355-2416

E-Mail

admsn@shawnee.edu

World Wide Web

<http://www.shawnee.edu>

Communication with Shawnee State will be easier if your first message is addressed to the people listed below. The telephone numbers listed provide direct access to those offices.

Admission and Retention: Director • 355-2221
 Alumni Affairs: Assistant Director, *Development* • 355-2284
 Arts and Humanities, Department of: *Chairperson* • 355-2300
 Arts and Sciences, College of: *Dean* • 355-2554
 Assessment Office: *Coordinator* • 355-2583
 Athletic Center: *Athletic Director* • 355-2285
 Athletics, Intercollegiate and Intramural: *Athletic Director* • 355-2285
 Books: *Bookstore Manager* • 355-2418
 Business Administration, Dpt. of: *Chairperson* • 355-2215
 Business Office (payment of bills): *Bursar* • 355-2279
 Cafeteria: *Manager* • 355-2578
 Campus Tours: *Director, Admission* • 355-2221 or 355-2557
 Career Planning and Placement Services: *Director* • 355-2259
 Clubs and Organizations: *Director, Student Activities* • 355-2217
 Continuing Education: *Director* • 355-2494
 Counseling and Psychological Services: *Director* • 355-2539

Degree Programs, Admission • 355-2221
 DENS (Dpt. of Educational Needs Services) *Director* • 355-2276
 Dental Hygiene Clinic • 355-2241
 Developmental Education: *Director* • 355-2277
 Disability Services • 355-2276
 Donations, Gifts, Bequests: *Director, Development* • 355-2284
 Financial Aid: *Director* • 355-2237
 Health Sciences, Department of: *Chairperson* • 355-2225
 Housing: *Coordinator* • 355-2628
 Industrial and Engineering Technologies, Department of: *Chairperson* • 355-2224
 International Students: *Advisor* • 355-2221
 Job Prep Program: *Director* • 353-6400
 Library/Media Services: *Director* • 355-2323
 Mathematical Sciences, Department of: *Chairperson* • 355-2301
 Minority Student Services • 355-2276
 Natural Sciences, Department of: *Chairperson* • 355-2301
 Orientation, New Student: *STARS* • 355-2594
 Personnel, Faculty: *Provost* • 355-2260
 Personnel, Staff: *Director, Personnel* • 355-2420
 Placement Testing: *Learning Center* • 355-2496
 Presidential and Trustee Affairs: *President* • 355-2289
 Professional Studies, College of: *Dean* • 355-2270
 Registration: *Registrar* • 355-2262
 Social Sciences, Department of: *Chairperson* • 355-2234
 Student Advising and Retention (STARS): *Coordinator* • 355-2594 or 355-2592
 Student Affairs: *Vice President* • 355-2280
 Student Employment: *Director, Career Planning and Placement* • 355-2213
 Student Newspaper: *Editor* • 355-2278
 Student Senate: *President* • 355-2320
 Student Support Services: *Director* • 355-2402
 Talent Search: *Director* • 355-2436
 Teacher Education, Dept. of • 355-2451
 Tech Prep: *Director* • 355-2281
 Transcripts: *Registrar* • 355-2262
 Transfer Admission: *Registrar* • 355-2262
 Tutoring: *Learning Center* • 355-2499
 University Center: *Director* • 355-2217
 Upward Bound: *Director* • 355-2439
 Veterans Coordinator: *Director, Financial Aid* • 355-2237

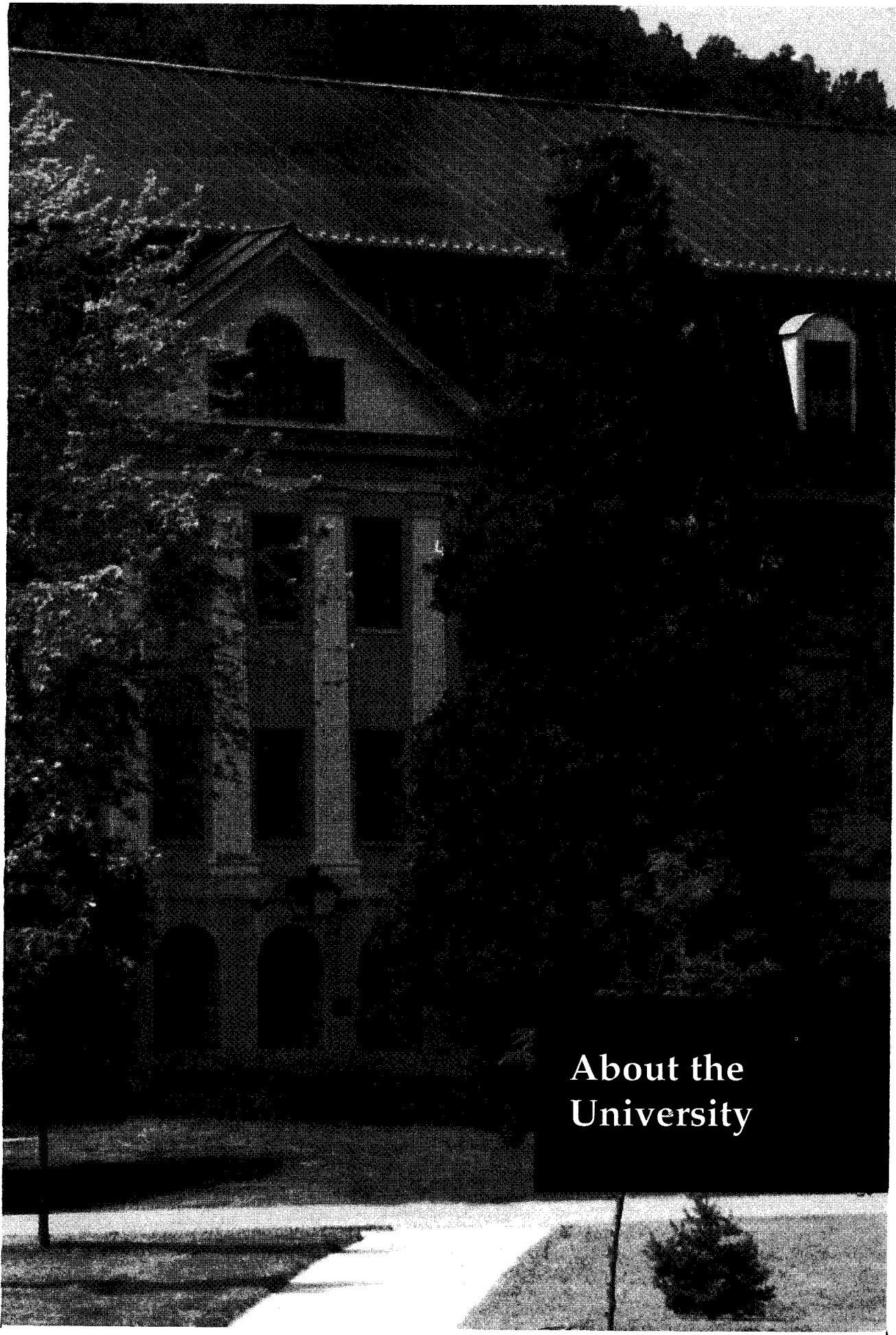

About the
University

Shawnee State University: Past and Present

In January of 1975, Shawnee State General and Technical College, created from a merger of the Ohio University regional campus and Scioto Technical College, was chartered by the Ohio Board of Regents to begin operation on July 1, 1975. The college, then operated on two campuses, moved to its present location in 1978. By an act of the Ohio Legislature (Senate Bill 229) on November 4, 1977, Shawnee State General and Technical College became Shawnee State Community College. Then in 1986, another act of the Legislature, put in effect on July 2, created Shawnee State University. Since then, the regional state university in South Central Ohio has continued to incorporate baccalaureate degree programs with the already successful associate degree programs.

Located on the Ohio River in downtown Portsmouth, Shawnee State is currently completing a massive campus expansion plan that, by the year 2000, will have brought more than \$100 million to the University for new buildings, remodeling of older buildings, landscaping, land acquisition, and parking.

The campus, which began with a single, five-story, classroom building, has expanded to include 26 buildings. A master plan created by Bohm-NBBJ of Columbus, Ohio, with input from Shawnee State and Portsmouth area community members, has created the vision for the institution's growth.

To accommodate the diverse educational needs of an expanding student population, Shawnee State's academic curriculum has continued to grow. Recent new academic programs include biology, chemistry, emergency medical technology, environmental engineering technology, environmental science, fine arts,

health management, history, mathematical sciences, medical laboratory science, occupational therapy, and sports studies.

The University offers associate degrees in 21 major fields, baccalaureate degrees in 17 major fields, certification in elementary and secondary education, and is in the continuing process of developing additional majors.

The Continuing Education Department provides various on- and off-campus learning opportunities for community participants. Its programs geared toward academically talented young people are popular year after year.

The University has also grown in importance and sphere of influence in other ways as well by offering high quality cultural, athletic, and educational events to students and the community at large.

Mission Statement

Shawnee State University—the regional state university of Southern Ohio—prepares students for the changing needs of business, industry, education, and society through its diversified degree programs. Recognizing the importance of knowledge, values, and cultural enrichment, Shawnee State University is committed to providing an undergraduate education that fosters competence in oral and written communication, scientific and quantitative reasoning, and critical analysis/logical thinking. To enrich the lives of the community, the University provides opportunities for continuing personal and professional development, intellectual discovery, and appreciation for the creative and performing arts.

Goals and Priorities

Dedication to undergraduate education. The University fulfills its mission by offering baccalaureate and associate degrees in the traditional academic fields, innovative interdisciplinary programs, and technical and career-oriented programs. These programs emphasize the interests of Appalachians and, because of the distinctiveness of selected degree programs in Ohio, also attract students from other areas of the nation and abroad. Moreover, SSU serves as the community and technical college for residents of Scioto, Lawrence, and

Pike Counties due to its historic development from a technical school, branch campus, and community college.

Focus on excellence in teaching. Teaching and learning are Shawnee State's most important functions. Service and scholarship, including creative activities and applied research, are essential parts of this function, especially as they inform teaching. Faculty are evaluated first and foremost on excellence in teaching and second on scholarship and/or service to the University and the community.

Dedication to motivating college attendance and graduation. Shawnee State University serves an ever-increasing number of traditional, nontraditional, and transfer students who find themselves competing for jobs and careers in a global technological society. The vision of larger size for the University is a calling to increase the quality of life of people—through education.

Pledge to developing cooperative relationships. As a state university, SSU fulfills Ohio's public service expectations by meeting state priorities, including the continuing education and training needs of business and industry. Shawnee State is, therefore, a willing partner in cooperative ventures with educational institutions and organizations that assist in developing the economic, educational, and cultural base of South Central Ohio.

Commitment to increasing quality. Shawnee State University is committed to a process of quality improvement in its desire to serve the changing needs of society, its institutions, and agencies. That improvement is implemented at SSU in several ways: conducting required academic program reviews every five years, meeting the quality standards of professional accrediting agencies, conducting multiple assessments of student learning outcomes, utilizing selective degree program advisory groups of practicing professionals, surveying alumni and employers annually, and applying Total Quality Improvement principles in selected classrooms and student-serving offices.

Vision Statements¹

A plan—especially a strategic plan—describes a destination. In 1989, the Shawnee State academic community embarked on a planning process which recommitted Shawnee State to its mission and established a set of goals intended to implement that mission. The enduring vision statements presented here, and adopted by the Shawnee State University Board of Trustees, are a natural outgrowth of that introspection and describe “what ought to be.”

- Recognizing its emerging role and scope, Shawnee State University will become established as THE Regional State University for Southcentral Ohio with visibility on a statewide and national level in select academic areas.
- Recognizing its responsibility to meet the educational needs of the citizens of the region, Shawnee State University will provide a comprehensive higher educational experience for its students.
- Knowing that its reputation stands on the quality of its academic programs, Shawnee State University will establish and maintain academic programs supportive of a focused academic mission founded primarily on technological, career oriented, and professional programs, including the liberal arts and sciences, which innovatively address the needs of the region.
- The continued strong development of Shawnee State University can only be accomplished through constructive collaboration among all constituencies, particularly those internal to the University. Such collegial collaboration can best occur in an environment in which all members are knowledgeable, treated equitably, and consider themselves a true and respected part of the future of the campus community. Accordingly, Shawnee State University will act to improve communication and coordination among members of the university community with a goal of informed decision making.

¹ The University's strategic plan is currently being modified. A revised plan is expected to be completed by the fall of 1997.

- Shawnee State University will enhance and manage the resources available to it in a manner that facilitates the attainment of its vision.

Strategies for implementing these enduring vision statements are included in *A View of the Future: Guidelines for Strategic Planning at Shawnee State University*, available in the Shawnee State Library or in the University's administrative offices.

Accreditations and Approvals

Shawnee State University is accredited by the North Central Association of Colleges and Schools, Commission on Institutions of Higher Education, 30 North LaSalle Street, Suite 2400, Chicago, IL 60602-2504. Graduates of the University are awarded baccalaureate and associate degrees and certificates.

In addition, the institution or specific programs are accredited or approved by the following agencies:

American Dental Association, Commission on Dental Accreditation
 American Occupational Therapy Association
 College Entrance Examination Board
 Commission on Accreditation in Physical Therapy Education
 Joint Review Committee for Respiratory Therapy Education, Commission on Accreditation of Allied Health Education Programs
 Joint Review Committee on Education in Radiologic Technology
 National Accrediting Agency for Clinical Laboratory Science
 Ohio Board of Nursing
 Ohio Board of Regents
 Ohio Department of Highway Safety, Division of Public Safety Services (EMT-A and Paramedic training programs)
 Social Security Department
 State of Ohio, Department of Education
 State of Ohio, Department of Education, Division of Vocational Education
 United States Department of Education

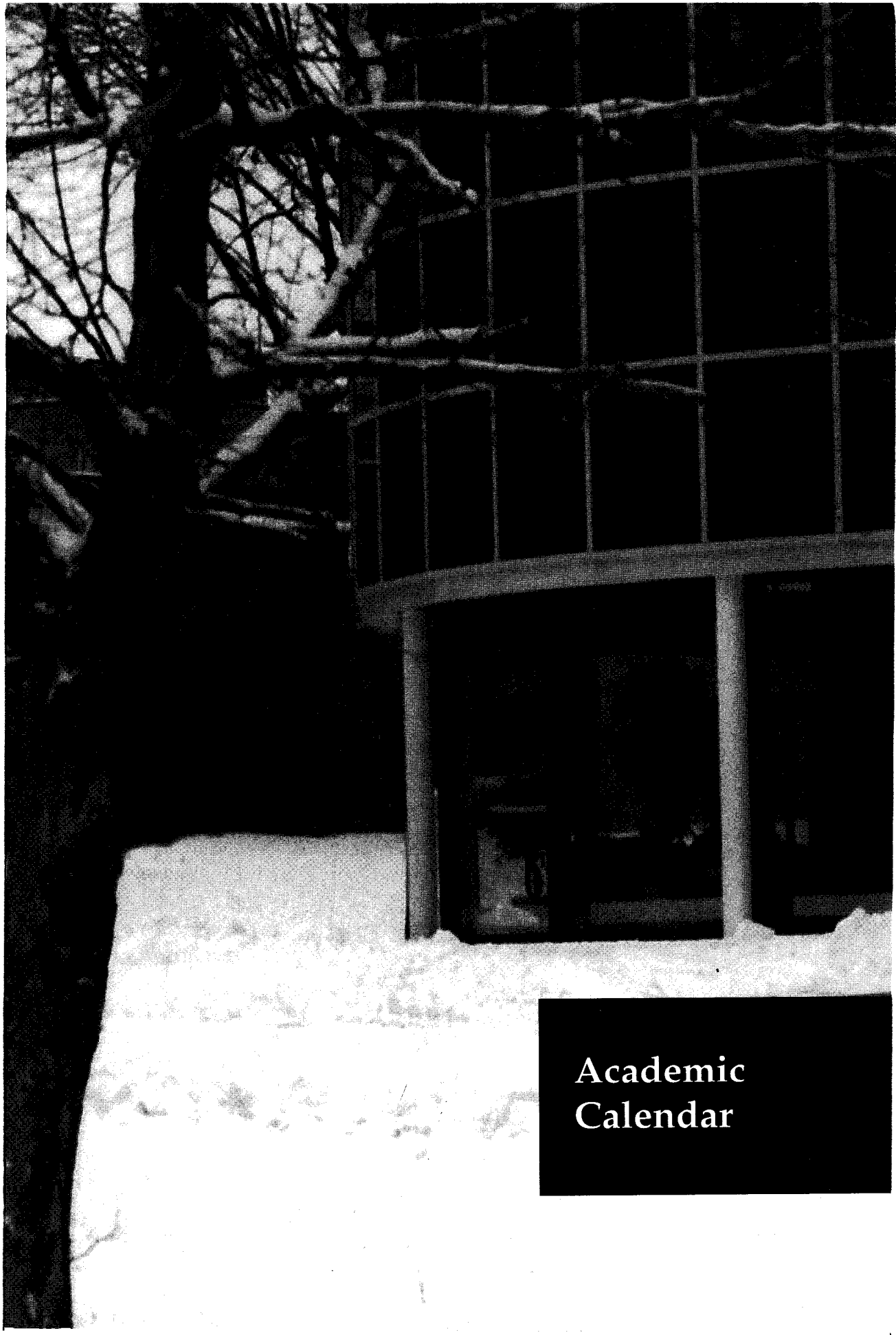

**Academic
Calendar**

1997-98 Academic Calendar

Summer Quarter, 1997

May 7	Advance registration opens for fall quarter
June 16	First day of summer quarter—classes begin (full summer qtr. and first five-week term); Last day for 100% refund for complete withdrawal (full summer qtr. and first five-week term); Late registration for summer quarter
June 18	Last day to add a class (first five-week term); Last day to apply for pass/no-credit (first five-week term)
June 20	Last day to add a class (full summer qtr.)
June 30	Last day to apply for pass/no-credit (full summer quarter)
July 4	Independence Day—University closed
July 7	Last day to drop a class (first five-week term)
July 8	Last day to apply for non-credit (first five-week term)
July 18	Last day of first five-week term; Final exams (first five-week term)
July 21	First day of second five-week term; Grades due to Office of the Registrar by noon (first five-week term); Last day for 100% refund for complete withdrawal (second five-week term)
July 23	Last day to add a class (second five-week term); Last day to apply for pass/no-credit (second five-week term)
August 1	Last day to apply for non-credit (full summer quarter);

August 4	Last day to apply for summer quarter graduation Last day to drop a class (full summer quarter)
August 12	Last day to drop a class (second five-week term); Last day to apply for non-credit (second five-week term)
August 14 August 22	Early registration for fall quarter Last day of quarter (full summer quarter and second five-week term)
August 25-26	Final exams (full summer quarter and second five-week term)
September 2	Grades due to Office of the Registrar by noon (full summer quarter and second five-week term)

Fall Intersession, 1997

August 27	Late registration; First day of intersession; Last day to add a class, apply for pass/no-credit, or receive 100% refund for complete withdrawal
September 1	Labor Day — University closed
September 10	Last day of intersession; Last day to drop a class or withdraw completely; Final exams
September 12	Grades due to Office of the Registrar by noon

Fall Quarter, 1997

May 7	Advance registration opens for fall quarter
August 14	Early registration for fall quarter
September 1	Labor Day — University closed
September 9	Late registration for fall quarter
September 11	First day of fall quarter — classes begin; Last day for 100% refund for complete withdrawal from fall quarter
September 17	Last day to add a class
September 24	Last day to apply for pass/no-credit
October 1	Last day to apply for fall quarter graduation

October 3	First day of Rosh Hashanah — University open
October 10	Yom Kippur — University open
October 13	Columbus Day — University open
October 29	Last day to apply for non-credit
October 31	Last day to drop a class
November 3	Advance registration opens for winter quarter
November 11	Veterans Day — University closed
November 19	Last day of fall quarter
Nov. 20-26	Final exams
November 27	Thanksgiving Day — University closed
November 28	University Closed (in lieu of Columbus Day)
December 2	Grades due to Office of the Registrar by noon

Winter Intersession, 1997

December 8	First day of intersession; Last day to add a class, apply for pass/no-credit, or receive 100% refund for complete withdrawal
December 19	Last day of intersession; Last day to drop a class or withdraw completely; Final exams
December 22	Grades due to Office of the Registrar by noon

Winter Quarter, 1998

November 3	Advance registration opens for winter quarter
December 5	Last day to apply for winter quarter graduation
December 24	First day of Hanukkah — University open
December 25	Christmas Day — University closed
December 26	University closed (in lieu of President's Day)
January 1	New Year's Day — University closed
January 5	First day of winter quarter — classes begin; Late registration for winter quarter; Last day for 100% refund for complete withdrawal from winter quarter

January 9	Last day to add a class
January 16	Last day to apply for pass/no-credit
January 19	Martin Luther King Day — University closed
February 9	Advance registration opens for spring and summer quarters
February 16	President's Day — University open
February 20	Last day to apply for non-credit
February 23	Last day to drop a class
March 13	Last day of winter quarter
March 16-20	Final exams
March 23	Grades due to Office of the Registrar by noon

Spring Quarter, 1998

January 30	Last day to apply for spring qtr. graduation (and participate in June commencement)
February 9	Advance registration opens for spring and summer quarters
March 30	First day of spring quarter — classes begin; Late registration for spring quarter; Last day for 100% refund for complete withdrawal from spring quarter
April 3	Last day to add a class
April 10	Last day to apply for pass/no-credit
April 12	Easter — University open
May 15	Last day to apply for non-credit
May 18	Last day to drop a class
May 25	Memorial Day — University closed
June 5	Last day of spring quarter
June 8-12	Final exams
June 12	Commencement
June 15	Grades due to Office of the Registrar by noon

Tentative 1998-99 Academic Calendar

The following calendar for the 1998-99 academic year is tentative and subject to change.

Summer Quarter, 1998

May 7	Advance registration opens for fall quarter
June 22	First day of summer quarter — classes begin (full summer qtr. and first five-week term); Last day for 100% refund for complete withdrawal (full summer qtr. and first five-week term); Late registration for summer quarter
June 24	Last day to add a class (first five-week term); Last day to apply for pass/no-credit (first five-week term)
June 26	Last day to add a class (full summer qtr.)
July 3	University closed (in observance of Independence Day)
July 4	Independence Day
July 6	Last day to apply for pass/no-credit (full summer quarter); Last day to drop a class (first five-week term)
July 14	Last day to apply for non-credit (first five-week term)
July 24	Last day of first five-week term; Final exams (first five-week term)
July 27	First day of second five-week term; Grades due to Office of the Registrar by noon (first five-week term); Last day for 100% refund for complete withdrawal (second

July 29	five-week term) Last day to add a class (second five-week term); Last day to apply for pass/no-credit (second five-week term)
August 3	Last day to apply for summer quarter graduation
August 7	Last day to apply for non-credit (full summer quarter)
August 10	Last day to drop a class (full summer quarter)
August 13	Early registration for fall quarter
August 18	Last day to apply for non-credit (second five-week term)
August 21	Last day to drop a class (second five-week term)
August 28	Last day of quarter (full summer quarter and second five-week term); Final exams (full summer quarter and second five-week term)
August 31	Grades due to Office of the Registrar by noon (full summer quarter and second five-week term)

Fall Intersession, 1998

August 31	First day of intersession; Last day to add a class, apply for pass/no-credit, or receive 100% refund for complete withdrawal
September 7	Labor Day — University closed
September 11	Last day of intersession; Last day to drop a class or withdraw completely; Final exams
September 15	Grades due to Office of the Registrar by noon

Fall Quarter, 1998

May 7	Advance registration opens for fall quarter
August 13	Early registration for fall quarter
September 7	Labor Day — University closed
September 10	Late registration for fall quarter
September 14	First day of fall quarter — classes begin; Last day for 100% refund for complete withdrawal from fall quarter
September 18	Last day to add a class

September 21	Rosh Hashanah — University open
September 25	Last day to apply for pass/no-credit
September 30	Yom Kippur — University open
October 2	Last day to apply for fall quarter graduation
October 12	Columbus Day — University open
October 30	Last day to apply for non-credit
November 2	Last day to drop a class; Advance registration opens for winter quarter
November 11	Veterans Day — University closed
November 20	Last day of fall quarter
Nov. 23-25	Final exams begin
November 26	Thanksgiving Day — University closed
November 27	University Closed (in lieu of Columbus Day)
Nov. 30-31	Final exams continue
December 2	Grades due to Office of the Registrar by noon

Winter Intersession, 1998

December 2	First day of intersession; Last day to add a class, apply for pass/no-credit, or receive 100% refund for complete withdrawal
December 4	Last day to apply for winter quarter graduation
December 18	Last day of intersession; Last day to drop a class or withdraw completely; Final exams
December 21	First day of Hanukkah — University open
December 22	Grades due to Office of the Registrar by noon

Winter Quarter, 1999

November 2	Advance registration opens for winter quarter
December 4	Last day to apply for winter quarter graduation
December 24	University closed (in lieu of President's Day)
December 25	Christmas Day — University closed
January 1	New Year's Day — University closed

January 4	First day of winter quarter — classes begin; Late registration for winter quarter; Last day for 100% refund for complete withdrawal from winter quarter
January 8	Last day to add a class
January 15	Last day to apply for pass/no-credit
January 18	Martin Luther King Day — University closed
January 29	Last day to apply for spring qtr. graduation (and participate in June commencement)
February 8	Advance registration opens for spring quarter
February 15	President's Day — University open
February 19	Last day to apply for non-credit
February 22	Last day to drop a class
March 12	Last day of winter quarter
March 15-19	Final exams
March 22	Grades due to Office of the Registrar by noon

Spring Quarter, 1999

January 29	Last day to apply for spring qtr. graduation (and participate in June commencement)
February 8	Advance registration opens for spring quarter
March 29	First day of spring quarter — classes begin; Late registration for spring quarter; Last day for 100% refund for complete withdrawal from spring quarter
April 2	Last day to add a class
April 4	Easter — University open
April 9	Last day to apply for pass/no-credit
May 10	Advance registration for fall quarter opens
May 14	Last day to apply for non-credit
May 17	Last day to drop a class
May 31	Memorial Day — University closed
June 4	Last day of spring quarter
June 7-11	Final exams
June 11	Commencement
June 14	Grades due to Office of the Registrar by noon



**Admission
Policies**

Admission to the University

Admission to degree programs at Shawnee State University is open to graduates who hold a state-approved diploma from state chartered or regionally accredited high schools and to students who have earned high school equivalency through the General Education Development (GED) program. However, admission to the University does not guarantee admission to specific programs of study. If you intend to apply for admission to a health science program in the College of Professional Studies, you should refer to the appropriate section of this catalog for specific admission requirements.

Admission to students not seeking a degree at Shawnee State University is also open. The minimum requirements for admission of all students, both degree seeking and non-degree seeking, include:

- A completed application for admission
- The current non-refundable application fee

There are varying additional requirements for students in different categories, including recent high school graduates, transfer students, special non-degree students, transient students, international students, and eligible students who are still attending high school. Requirements for each are discussed in the following sections.

It is recommended that the high school background of the entering freshman pursuing a degree include:

- 4 units English
- 3 units mathematics (algebra 1 and 2, geometry)
- 3 units social studies
- 3 units science
- 2 units foreign language
- 1 unit visual, performing arts (drama, music, art)

These courses are recommendations, not requirements. However, if you have a deficiency in English or mathematics, you will be required to take developmental courses prior to attempting college level work.

ACT/SAT

It is highly recommended that students pursuing the four-year baccalaureate or two-year associate degrees or the one-year certificates have scores from the American College Test (ACT) or Scholastic Aptitude Test (SAT) forwarded to Shawnee State University.

Although Shawnee State has an open admission policy and does not use the ACT or SAT for determining admission to the University, it does require results of these tests if used to waive the required university placement tests. Also, please note that many of our Shawnee State scholarships require specific ACT scores for consideration in meeting the minimum application criteria. In addition, the ACT is required of all applicants for admission to some of the health sciences programs. Specific information about required scores is stated in that section of this catalog.

You may contact the Shawnee State University Office of Admission for information about future ACT test dates.

Degree-Seeking High School Graduates

High school graduates who have been awarded a state-approved diploma are required to submit a final, official transcript of academic work to Shawnee State University. Students may send a high school transcript request form (available in the Admission Office) or a written request to the high school requesting an official transcript to be forwarded directly to the University.

Transcripts may be mailed directly from the high school to the following address: Office of Admission, Shawnee State University, 940 Second Street, Portsmouth, Ohio 45662-4344. Applicants may also hand-carry the transcript in an envelope sealed with a guidance

counselor's signature. Guidance counselors or high school officials may send transcripts via FAX to [614] 354-7794 if accompanied by a signed transmittal form or by electronic transfer. The University reserves the right to verify the final, official authenticity of any student's transcript. Any transcript document found to be fraudulent becomes the student's responsibility and the University reserves the right to withdraw admission acknowledgement and/or approval of acceptance.

You will not be permitted to register as a degree-seeking student if the University is not in receipt of your final, official high school transcript (or GED). You may register as a special non-degree student, but are ineligible for financial aid awards.

Advanced Placement

You may be awarded college credit for satisfactory performance on certain proficiency examinations. Each May, participating high schools provide their students with an opportunity to take examinations in a variety of subject areas through the Advanced Placement Program (AP™), sponsored by the College Board and administered by Educational Testing Service (ETS). Students who achieve a grade of 3 or above may receive college credit on the basis of these examinations. Credit given through the AP program does not apply toward the residency requirement for graduation.

In addition, Shawnee State University recognizes that some courses completed in high school or vocational school may be equivalent to some entry-level coursework at Shawnee State. In order to avoid repetition of such courses and to encourage advanced study in the respective disciplines, Shawnee State has entered into "Articulation Agreements" with high schools, vocational schools, and school districts. This allows the award of advanced placement credit for certain coursework completed at the high school where articulation agreements are in place. Such credit waives your course requirement. A more advanced class must be completed to replace the waived course.

Please contact the registrar for information concerning eligibility for credit through advanced placement.

Applicants with the GED

Students who have successfully completed the GED may use the special GED transcript request form (available in the admission office) to have official GED transcripts sent to the University or they may request official transcripts directly from the State GED Office, Ohio Department of Education, 65 South Front Street, Room 812, Columbus, Ohio 43266-0308 or State GED Office, Kentucky Department of Education, Frankfort, Kentucky 40601.

Transcripts should be mailed to the following address: Office of Admission, Shawnee State University, 940 Second Street, Portsmouth, Ohio 45662-4344. Transcripts must be received directly from the State GED Office.

You will not be permitted to register as a degree-seeking student if the University is not in receipt of your final, official high school transcript (or GED). You may register as a special non-degree student, but are ineligible for financial aid awards.

Undeclared Major/Undecided Student

If you intend to pursue a degree but are undecided about a major, you may remain "undeclared" until you earn your first 45 quarter hours of credit. At the completion of 45 hours, you are required to declare a major or you are prohibited from registering for classes.

Transfer Students

Students who have attended other regionally accredited colleges or universities may transfer to Shawnee State University provided they were in good academic standing at the institution attended most recently. In addition to the application for admission, application fee, and high school transcript, you are required to provide an official transcript from each college

or university previously attended. College transcripts must be received directly from those institutions. Photocopies, fax, and hand-carried transcripts are not accepted. You may be admitted as a "provisional student" until such time as the official transcripts are received from all previous colleges. Lastly, if you are applying for financial aid at Shawnee State University, you must have each college/university previously attended send your financial aid transcript to the financial aid office at Shawnee State.

Credits applicable to the curriculum for which you are applying which were earned at regionally accredited colleges or universities are accepted at the time of admission. Generally, courses completed with a grade of "C" or better are eligible for transfer. Under certain circumstances, a "D" may be transferable. See the registrar for further information. The credit hours transferred do not become a part of the grade point average at Shawnee State University.

To receive transfer credit, you must file an official transcript of previous college work. You must earn a minimum of 30 credit hours at Shawnee State University to be considered for the award of an associate degree and a minimum of 45 credit hours to be considered for the award of a baccalaureate degree.

If you have attended non-regionally accredited colleges or universities, you may transfer to Shawnee State University provided you meet all admission standards applicable to other transfer students. Credits applicable to the curriculum for which you are applying which were earned at non-regionally accredited institutions will be considered for acceptance as transfer credit if:

- You have completed the associate degree at that institution, and
- You validate the award of credit by completing, with a grade of "C" or better, a planned program of courses totaling a minimum of 30 credit hours applicable to a four-year curriculum as approved by the registrar. For students transferring credit from non-regionally accredited colleges or universities, a maximum of 90 quarter hours will be considered for transfer.

State Policy On Articulation and Transfer

Institutional Transfer. The Ohio Board of Regents, following the directive of the Ohio General Assembly, has developed a new state-wide policy to facilitate movement of students and transfer credits from one Ohio public college or university to another. The purpose of the State Policy is to avoid duplication of course requirements and to enhance student mobility throughout Ohio's higher education system. Since independent colleges and universities in Ohio may or may not be participating in the transfer policy, students interested in transferring to an independent institution are encouraged to check with the college or university of their choice regarding transfer agreements.

Transfer Module. The Ohio Board of Regents' Transfer and Articulation Policy established the Transfer Module, which is a specific subset or the entire set of a college or university's general education requirements. The Transfer Module contains 54-60 quarter hours or 36-40 semester hours of specified course credits in English composition, mathematics, fine arts, humanities, social science, behavioral science, natural science, physical science, and interdisciplinary coursework.

A transfer module completed at one college or university will automatically meet the requirements of the transfer module at the receiving institution, once the student is accepted. Students may be required, however, to meet additional general education requirements that are not included in the Transfer Module.

Conditions for Transfer Admission. Students meeting the requirements of the Transfer Module are subject to the following conditions:

1. The policy encourages receiving institutions to give preferential consideration for admission to students who complete the Transfer Module and either the associate of arts or the associate of science degrees. These students will be able to transfer all courses in which they received a passing grade of "D" or better. Students must have an overall grade point average of 2.0 to be given credit for the Transfer Module.
2. The policy also encourages receiving institutions to give preferential consideration for admission to students who complete the

Transfer Module with a grade of "C" or better in each course and 90 quarter hours or 60 semester hours. Students must have an overall grade point average of 2.0 to be given credit for the Transfer Module and only courses in which a "C" or better has been earned will transfer.

3. The policy encourages receiving institutions to admit, on a non-preferential consideration basis, students who complete the Transfer Module with a grade of "C" or better in each course and less than 90 quarter hours or 60 semester hours. These students will be able to transfer all courses in which they received a grade of "C" or better.

Admission to a given institution, however, does not guarantee that a transfer student will be automatically admitted to all majors, minors, or fields of concentration at that institution. Once admitted, transfer students shall be subject to the same regulations governing applicability of catalog requirements as all other students. Furthermore, transfer students shall be accorded the same class standing and other privileges as native students on the basis of the number of credits earned. All residency requirements must be successfully completed at the receiving institution prior to the granting of a degree.

Responsibilities of Students. In order to facilitate transfer with maximum applicability of transfer credit, prospective transfer students should plan a course of study that will meet the requirements of a degree program at the receiving institution. Specifically, you should identify early in your collegiate studies an institution and major to which you desire to transfer. Furthermore, you should determine if there are language requirements or any special course requirements that can be met during the freshman or sophomore year. This will enable you to plan and pursue a course of study that will articulate with the receiving institution's major. You are encouraged to seek further information regarding transfer from both your advisor and the college or university to which you plan to transfer.

Appeals Process. A multi-level, broad based appeal process is required to be in place at each institution. A student disagreeing with the application of transfer credit by the receiving institution shall be informed of the right to appeal the decision and the process for filing

the appeal. Each institution shall make available to students the appeal process for that specific college or university.

If a transfer student's appeal is denied by the institution after all appeal levels within the institution have been exhausted, the institution shall advise the student in writing of the availability and process of appeal to the state level Articulation and Transfer Appeals Review Committee.

The Appeals Review Committee shall review and recommend to institutions the resolution of individual cases of appeal from transfer students who have exhausted all local appeal mechanisms concerning applicability of transfer credits at receiving institutions.

Appeal Procedure Regarding Transfer Credit Applicability

Historical Context. On November 16, 1990, the Ohio Board of Regents passed a resolution mandating that public institutions of higher education establish a multilevel appeal procedure to be followed by students dissatisfied with the applicability of transferred credit. The following multilevel appeal procedure at Shawnee State University is designed to meet the needs of these students and to comply with the Ohio Board of Regents' mandate.

Acceptance of Transfer Credit. Transfer credit is awarded and posted to your Shawnee State University transcript in accordance with accepted national and state standards. Generally, all courses satisfactorily completed at regionally accredited institutions are transferable. The Office of the Registrar is responsible for posting this credit to your transcript.

Applicability of Transfer Credit. After transfer credit has been posted to your transcript, the Office of the Registrar posts the courses to your Degree Audit and provides you with a copy of the audit.

Multilevel Appeals Procedure. State mandate requires that you be notified of your right to appeal a transfer credit applicability decision. You must file your written appeal within ninety days following receipt of your Degree Audit. The University must respond to your appeal within thirty days of receipt of the appeal, at each appeal level. The appeal levels are defined on page 20.

Shawnee State University Transfer Module

Field	General Education Requirements Applied to TM	Additional General Education Requirements (12-14 sem., 18-24 qtr.)	Additional General Education Requirements Beyond the TM for Graduation
English minimum 6 qtr./3 sem.	ENGL 111S (4) ENGL 115S (4)	ENGL 232 (3) ENGL 240 (3) ENGL 245 (3)	ENGL112 (4)
Mathematics minimum 3 qtr./3 sem.	One of the following: MATH 110S (4) MATH 220 (4) MATH 131 (4) MATH 250 (4) MATH 201	MATH 132 (4) MATH 202 (4)	
Arts/Humanities minimum 9 qtr./6 sem.	ENGL/HIST 225S (4) or 226S (4) and two of the following: ARTH 101 (4) MUSI 120 (4) ENGL/HIST 227S (4) MUSI 220 (4) ENGL275 (4) THAR 100 (4) HIST 260 (4)	ARTH 261 (4) MUSI 221 (4) ARTH 262 (4) MUSI 222 (4) ENGL 200 (4) MUSI 223 (4) ENGL 203 (4) PHIL 100 (4) ENGL 210 (4) PHIL 103 (4) ENGL 211 (4) PHIL 105 (4) ENGL 212 (4)	
Social Science minimum 9 qtr./6 sem.	Choose from two disciplines. One of the following: ANTH 250 (4) SOCI 101 (4) GEOG 130 (4) SOCI 110S (4) and two of the following: ANTH 101 (4) HIST 111 (4) ECON 101 (4) HIST 112 (4) GEOG 125 (4) HIST 113 (4) GOVT 101 (4) PSYC 101 (4)	ECON 102 (4) HIST 203 (4) GOVT 240 (4) PSYC 151 (4) GOVT 250 (4) PSYC 273 (4) HIST 201 (4) SOCI 201 (4) HIST 202 (4) SOCI 205 (4)	
Natural Sciences minimum 9 qtr./6 sem.	One of the following two options: Option 1 Two courses from the following: BIOL 151 (5) CHEM 143 (4) BIOL 202 (5) GEOL 111 (4) CHEM 121 (4) GEOL 112 (4) CHEM 122 (4) PHYS 201 (4) CHEM 141 (4) PHYS 202 (4) CHEM 142 (4) PHYS 203 (4) Option 2 Minimum of 12 hours from the same set of courses	One additional course beyond the satisfaction of Option 1 from the following: BIOL 162 (5) GEOL 201 (4) BIOL 203 (5) GEOL 202 (4) CHEM 200 (4) NTSC 240 (4) CHEM 240 (4) PHYS 210 (4)	
Interdisciplinary			
Subtotal minimum 36 qtr./24 sem.	44-48 Hours	7-12 Hours	Other Take BUBA/ENGL/ETCO/NTSC/ SOCI 490S and one of the following: BUMG 331 (4) PHIL 334 (4) PHIL 320S (4) ROCI 485S (4) PHIL 332 (4)
Total	55-56		
54 - 60 quarter hours			
36 - 40 semester hours			

Level 1

You meet with the dean of the college in which you are enrolled to discuss the course(s) in question. If both the dean and you are in agreement that a change in applicability is desirable, the dean reports the necessary change with rationale to the registrar. If the dean determines that an applicability change is not warranted, the dean notifies you, the Transfer Credit Appeals Committee chair, and the provost regarding the decision and the rationale.

Level 2

If you and the dean are unable to reach a mutually agreeable resolution, you present your case before the Transfer Credit Appeals Committee. The Transfer Credit Appeals Committee is charged with reviewing the manner in which transfer credit has been applied to your degree program when you and the appropriate dean are unable to reach a mutually satisfactory agreement. The committee may vote to support the dean's position, your position, or suggest alternatives for the dean and you to consider. This committee reports to the provost and is composed as follows:

- One faculty representative from each of the following departments
 - Arts and Humanities
 - Business Administration
 - Health Sciences
 - Industrial and Engineering Technologies
 - Mathematical Sciences
 - Natural Sciences
 - Social Sciences
 - Teacher Education
- The registrar and the GEP coordinator serve as voting ex officio members of the committee.

If the committee determines that a change in applicability is desirable, the committee chair reports the necessary change with rationale to you, the dean, and the registrar. If the committee determines that an applicability change is not warranted, the committee chair notifies you, the dean, and the provost regarding the decision and the rationale.

Level 3

If you and the Transfer Credit Appeals Committee are unable to reach a mutually agreeable resolution, you present your case to the provost. If the provost determines that a change in applicability is desirable, he or she

reports the necessary change with rationale to you, the dean, the Transfer Credit Appeals Committee chair, and the registrar. If the provost determines that a change in applicability is not warranted, the provost notifies you, the dean, and the Transfer Credit Appeals Committee chair of the decision and the rationale. You have no further recourse within the institution. However, if you wish to pursue the matter further, a statewide appeals procedure is available.

Transfer Credit Appeals Committee Membership. Faculty representatives to the Transfer Credit Appeals Committee are determined by a procedure agreed upon by the faculty within their respective units as indicated in Level 2. Committee members annually elect a chair. The committee chair votes only in the event of a tie. Staggered terms of three years begin January 1. Elected representatives may be required to meet during the summer months if a student submits an appeal during that time period. Deans may appoint alternates if necessary. The registrar and the GEP coordinator serve as voting ex officio committee members.

International Students

International students who are seeking admission to Shawnee State University must submit the following materials:

- An application for admission accompanied by the current application fee.
- All official secondary and postsecondary transcripts. These transcripts must be in the student's native language and be accompanied by a certified English translation. If these credentials cannot be evaluated by the University, they will be sent to an evaluation service, and you will be responsible for the cost of the evaluation.
- An official score of 500, at a minimum, on the Test of English as a Foreign Language (TOEFL) or an equivalent score on the Michigan Test of English Language Proficiency (MTELP) is required for admission to a degree program for students whose native language is not English.
- Proof of financial resources which are adequate to support the student for one year.

If you intend to finance your education yourself, you must supply a statement from your bank showing funds equal to those required for one year. If you are being sponsored, an affidavit of support and a bank statement showing adequate funds for one year must be submitted. In addition, all international students are required to submit a deposit equal to one thousand U.S. dollars (\$1,000.00)¹ prior to the issuing of an I-20. This deposit will be held by the University and will be returned only when you (1) graduate from Shawnee State, (2) transfer to another college/university, or (3) withdraw from Shawnee State. You must petition the business office, on the required form, for the return of your deposit. Your deposit is returned only for the three reasons stated here and only after all financial obligations to the University have been met.

International students are required to accept the cost of university health insurance or produce proof of adequate insurance while in the United States. A one-time International Student Orientation Fee of \$200.00 is also charged with the initial billing for tuition and fees.

Those international applicants who are accepted for admission will receive an acceptance letter and an I-20 form to be used to secure a student visa. The acceptance letter and I-20 will not be issued until the Office of Admission has received all required materials. To be assured consideration for admission, all required materials must be received 60 days prior to the beginning of the quarter in which you plan to enroll.

Questions pertaining to a student visa should be directed to the local office of the Department of Immigration.

Non-Degree Students

Special Non-Degree Students

Students who are not interested in pursuing a degree but who wish to take courses are required to file an application for admission with the current application fee. Transcripts of high school and college work are not required, nor is ACT/SAT testing. However, if at a later time, you decide to pursue a degree program, all admission requirements in effect at the time of initial enrollment must be met. These requirements include official transcripts from high school (and/or GED) and college work and testing, recommendations, etc., if any of these are required for the major being declared.

Students enrolled in the GED program are special, non-degree students and, as such, are not required to take the ACT. If, after completion of the GED, you wish to pursue a degree, you will be subject to requirements for admission of a degree applicant.

Special, non-degree students may take courses which have no prerequisites or courses for which they have the appropriate prerequisite. For courses assuming prior knowledge or a certain degree of proficiency, placement testing may be advised or required prior to registration.

Transient Students

Students who are enrolled at or seeking a degree at another college or university, but who wish to take coursework temporarily at Shawnee State University, are considered transient students. As non-degree students (at Shawnee State), such students are required only to file an application for admission with the current application fee.

Although transcripts of high school and college work are not required of transient students, such transcripts, especially those from your home campus, are helpful in advising appropriate coursework. Unofficial transcripts or grade cards are acceptable if these are needed to verify prerequisites for courses to be taken at Shawnee State University.

¹Shawnee State University reserves the right to request full payment in advance.

Transient students are strongly advised to consult with the appropriate counselor or advisor at the home college or university as to the appropriate coursework to be taken at Shawnee State and how that coursework will transfer to the home campus of the transient student.

If, as a transient student, you decide to seek a degree at Shawnee State University, you become a "transfer student" and are bound to all requirements for a degree-seeking transfer student, including whatever requirements existed for the major to be pursued at Shawnee State at the time of your initial enrollment.

Senior Citizens

Shawnee State University admits senior citizens (60 years of age or older) for courses, on an audit, space-available basis. Although formal application and registration are required, no tuition fees are charged. Lab fees are charged when applicable. Senior citizens who wish to take courses for credit are charged the usual tuition and fees.

There is also a special, no cost, fitness program for seniors. Applications may be obtained at the James A. Rhodes Athletic Center.

Academically Advanced High School Students

Juniors and Seniors

The Postsecondary Options Program (POP) offers academically talented high school juniors and seniors the opportunity to take, in a college setting, courses which enhance coursework available at their high schools and which are clearly at the collegiate level.

Because the courses taken under this option are at the collegiate level, it should be expected that these courses are more demanding and completed at a faster pace than those taken in high school. They generally require more out-of-class preparation than high school classes. You and your parents should also consider the emotional and social maturity necessary to study in an adult environment in which most students are in their late teens/early twenties and assess your ability to accept independence and responsibility for your academic performance.

Eligibility

To be eligible for the Postsecondary Options Program, you must:

- Be a resident of the state of Ohio.
- Have completed at least the sophomore year of high school and be of junior status, as defined by the school district.
- Be commuting from your permanent residence and attending a high school within commuting distance.
- Have unscheduled time available in your high school day (not counting lunch period). S.B. 140 allows only as many college courses as you have free periods in your high school day.
- Provide evidence of a high school GPA of 3.0 on a 4.0 scale. (The 3.0 GPA is not required for summer quarter attendance by high school students.)
- Take a placement test and place at a collegiate level in reading, English, and mathematics (i.e., 100 level or above). POP applicants who have taken the ACT and scored 22 on the English and mathematics sections need not take the placement tests.
- Maintain a cumulative GPA of 2.0 (C average) for coursework at Shawnee State, and a 3.0 cumulative GPA (including transferred Shawnee State coursework) at your high school.
- Submit the application for admission, official high school transcript, and copy of the completed acknowledgement form from the high school to the Office of Admission by the May 15 deadline. Placement testing must also be completed by this deadline.

Under this program, qualified students have two options:

Option A (college credit only)

- You must take placement tests and place at collegiate levels.
- You/your parents/your guardian pay for tuition, fees, books, and materials.

Option B (high school and college credit)

- You must take placement tests and place at collegiate levels.
- You should seek counseling from high school personnel as to which college courses will meet graduation requirements at your school.

- Tuition, fees, books, and materials are paid for by the state, based on an established formula. Note: If you withdraw prior to the end of the quarter, any and all fees become the responsibility of you and your parent(s) or guardian(s).
- Successfully completed courses under Option B receive appropriate high school credit as determined by your school district. The college credits earned at Shawnee State University as a high school student may be applied toward a Shawnee State degree or transferred to another university according to the transfer policies of the receiving institution.
- Courses may be taken under Option B during fall, winter, and spring quarters only.

Application

You must complete the POP application for admission and submit it to your high school counselor. The application fee has been waived for POP students. The counselor should then send, to the Office of Admission, the application, the current transcript of high school grades, the Shawnee State verification form, and a copy of the acknowledgement form used by the high school when advising students and parents of the advantages, risks, and responsibilities involved in participation in the program. The acknowledgement form must bear the signatures of the applicant, parent(s), and high school official. To participate in the POP program at any time during your junior or senior academic year, you must meet all requirements and apply by the May 15 deadline in the previous academic year. Students are not admitted after the May 15 deadline.

- The counselor must attach a current high school transcript to the completed application and acknowledgement form and forward them, with the application fee and the Shawnee State verification form, to the Office of Admission. A current transcript is required for each quarter of enrollment. The acknowledgement form need be submitted only once, at the time of application.
- Deadlines for updated transcript and verification forms are:

Fall Quarter
Winter Quarter
Spring Quarter

June 15¹
November 15
March 15

Registration

- A required day of orientation/registration is held in August, at which time advisors will help you with course selection and registration, which is on a space-available basis. Classes are subject to cancellation. Registration dates for subsequent quarters will be announced.
- Students admitted to this program are permitted to register for most courses numbered at the 100 or 200 level, provided necessary prerequisites are met. We strongly recommend that courses required for high school graduation (English, American History, and Government) be taken at the high school.
- You may take a maximum of 16 credit hours per quarter, provided you have a sufficient number of free periods per day at your high school, not counting lunch period. A provision of S.B. 140 requires one free period per day at the high school for each college class taken.
- You must attempt the courses as regularly graded courses. No grading options except A-F are available to students enrolled in this program.

Program Continuation

Students participating in the Postsecondary Options Program are required to maintain a cumulative grade point average (GPA) of at least 2.0 for all college courses completed. Students whose cumulative GPA falls below 2.0 are not permitted to continue in the Postsecondary Options Program. Further, you must remain in academic and disciplinary "good standing" at the University and your local high school to remain eligible for this program. **Note:** Shawnee State University will honor any disciplinary action taken by the high school affecting a student in the POP program.

¹ Only the transcript for the academic year is due on this date. All other required materials are due on May 15.

Acceptance, Notification, and Reporting

- In compliance with the law, ten days after completion of the application process, the following individuals are notified regarding admission status: the student, the student's parents (or guardian), the high school counselor, the district superintendent, and the state superintendent.

Validation of Credit

- Grades are reported to you and/or your parent(s) or guardian as appropriate.
- For students who have chosen to use courses to complete high school requirements, the University will supply an official transcript of grades to the student's high school principal/counselor.

Other High School Students

Freshmen and sophomore students in high school may enroll under the following requirements:

- Courses are to be taken for college credit only.
- Tuition, books, and fees are the responsibility of the student/parent(s)/guardian.
- You may attend only one course per quarter.
- You must show evidence of a 3.0 (A=4.0) grade point average (GPA) in your local high school.¹ (The 3.0 GPA is not required for summer quarter attendance by high school students.)
- You must apply for admission, submitting the high school application for admission and the non-refundable application fee, and provide a written recommendation by your high school counselor or principal along with written permission from your parent(s)/guardian.
- School and parent/guardian recommendation and permission forms must be submitted each quarter of enrollment.
- Your course schedule must be approved by the Office of Admission or the Registrar.

Non-POP Juniors and Seniors

Juniors and seniors **not** participating in the Postsecondary Options Program may enroll at Shawnee State University under the following requirements:

- Courses are to be taken for college credit only.
- Tuition, books, and fees are the responsibility of the student/parent(s)/guardian.
- You must show evidence of a 3.0 (A=4.0) grade point average (GPA) in your local high school.¹ (The 3.0 GPA is not required for summer quarter attendance by high school students.)
- You must apply for admission, submitting the high school application for admission and the non-refundable application fee, and provide a written recommendation by your high school counselor or principal along with written permission from your parent(s)/guardian.
- School and parent/guardian recommendation and permission forms must be submitted each quarter of enrollment.
- Your course schedule must be approved by the Office of Admission or the Registrar.
- Students may enroll for a maximum of 12 credit hours per quarter.

Campus Tours

The Office of Admission, located in the University Center, offers group tours of campus, Monday through Friday, at 10:00 a.m., 1:00 p.m., and 3:00 p.m. The office also schedules Saturday appointments. For an individual campus tour and personal appointment, please contact the Office of Admission at (614) 355-2221 to schedule a time that's convenient for you.

¹ The Office of Continuing Education may offer special programming which is exempt from the 3.0 GPA requirement.

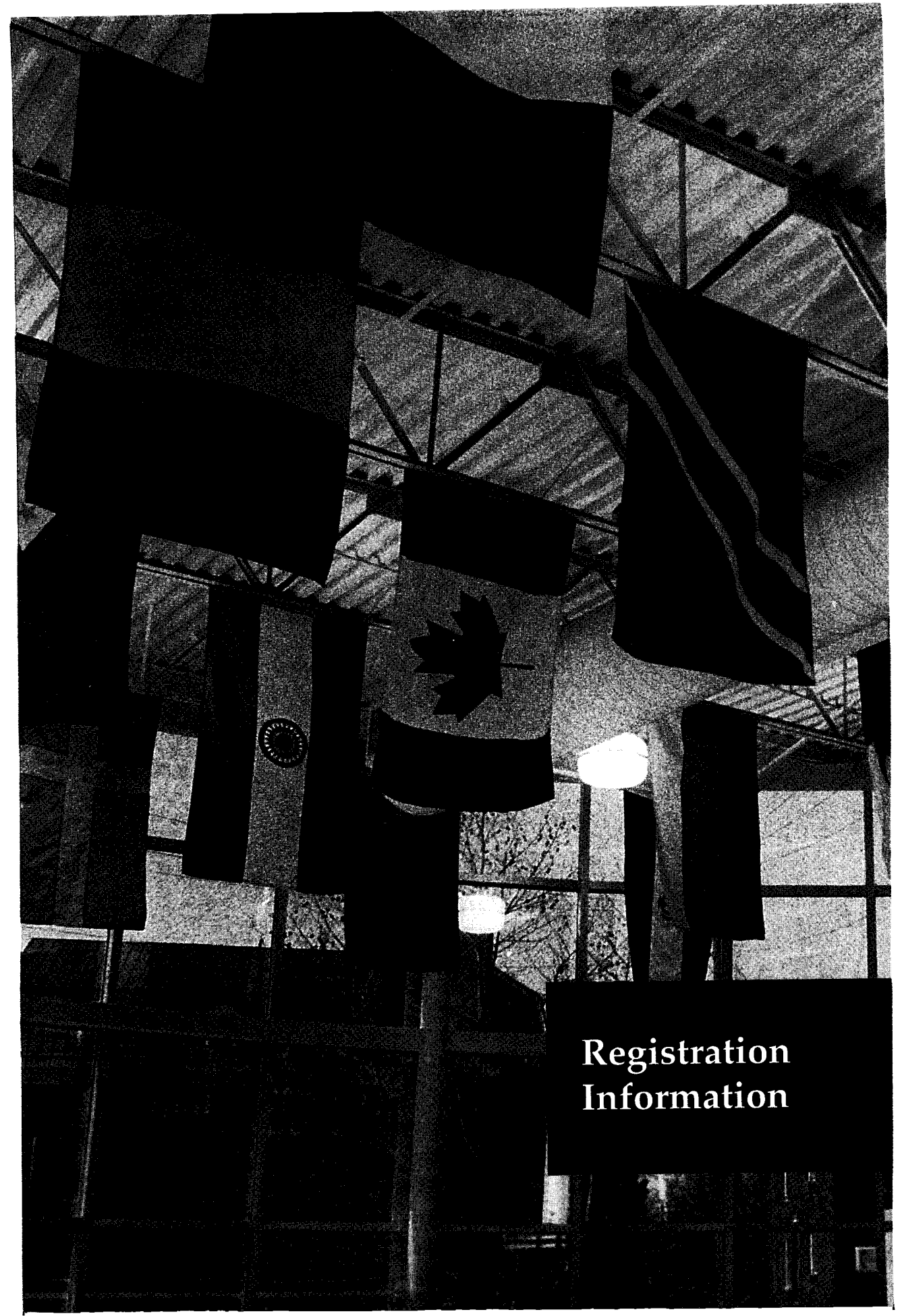

Registration Information

Registration

New students for fall quarter must register for their initial quarter during the New Student Orientation held each July. (See "Orientation," on page 27.)

If you are a degree-seeking freshman, you must contact Student Advising and Referral Services (STARS). Staff there help you obtain an advisor who assists you in planning your schedule. The approval signature of the academic advisor is **required** of degree-seeking freshmen with fewer than 45 credit hours earned. (See page 28 for more information on the STARS office.)

Continuing or returning students may register for subsequent quarters during advance or late registration. (Dates are found in the Academic Calendar, beginning on page 10.)

"Preferential registration" is available during the advance registration period for currently enrolled sophomores in associate degree programs and seniors in bachelor degree programs. Only the above students may submit registration forms during the preferential registration time period (see the quarterly course schedule for applicable dates).

The Office of the Registrar is open 7:30 a.m. to 5:30 p.m., Monday through Thursday, and 7:30 a.m. to 5:00 p.m. on Friday.

Improper Registration

Admission or registration may be canceled by the director of admission and retention or the registrar in cases of improper registration or when false or incomplete information is provided on the application for admission, registration forms, or other official documents. In such cases, you will be notified in writing as to the action that was taken and the reasons for such action.

Selective Service Registration

Ohio law requires male students between the ages of 18 and 26 to be registered with the Selective Service System, unless they are on active duty with the armed forces of the United States (other than the National Guard or reserves) or legally excluded, to be eligible for state educational assistance programs. Residents

who are not registered or have not indicated they do not need to register by the first day of the quarter are required by Ohio law to pay the out-of-state tuition. You can register with Selective Service in the year you become 18, and you must complete registration by 30 days after your 18th birthday. Selective Service registration can be accomplished in a few minutes at any U.S. Post Office. If you wish to indicate exempt status, you can request materials to do so by contacting the Office of the Registrar.

Residency Information

A nonresident surcharge is assessed to any student who does not qualify as a resident for subsidy and tuition surcharge purposes, in addition to other university fees. You are treated as a resident of Ohio and are assessed in-state fees if:

- You are dependent upon at least one parent or legal guardian who has been an Ohio resident for the 12 months preceding your enrollment.
- You have been a resident of Ohio for the 12 months preceding your enrollment and during this time you have not received financial support from outside the state.
- You are the dependent child of a parent or legal guardian, or the spouse of a person, who, as of the first day of your enrollment, has accepted full-time employment and established a domicile in Ohio for other reasons than gaining the benefit of favorable tuition rates.

You may also qualify if you are self-supporting while in Ohio pursuing a part-time course of study (conditional residents), are stationed in Ohio while on active duty in the military or have been an Ohio resident while involved in active duty military service prior to enrollment, have worked as a migrant in Ohio, or have been requested to be out of the country by your employer. If you qualify under one of these conditions, your dependents may qualify as well.

Proof of residency may be presented in a Request for Resident Classification to the Office of the Registrar. This form and all documentation must be submitted by the following deadline dates in order to be effective for the desired quarter:

- May 1 for summer quarter
- August 1 for fall quarter
- November 1 for winter quarter
- February 1 for spring quarter

Retroactive residency determinations cannot be made for tuition surcharge purposes.

For information on residency, conditional residency, Selective Service requirements, or to receive a Request for Resident Classification, write or visit the Office of the Registrar.

Notification of Rights Under the Family Educational Rights and Privacy Act

The Family Educational Rights and Privacy Act (FERPA) affords students certain rights with respect to their education records. They are:

1. The right to inspect and review the student's education records.
2. The right to request the amendment of the student's education records to ensure that they are not inaccurate, misleading, or otherwise in violation of the student's privacy or other rights.
3. The right to consent to disclosures of personally identifiable information contained in the student's education records, except to the extent that FERPA authorizes disclosure without consent.
4. The right to file with the U.S. Department of Education a complaint concerning alleged failures by the State University to comply with the requirements of FERPA.
5. The right to obtain a copy of the State University's student records policy. You can obtain a copy of the policy from the registrar's office.

Orientation

Student orientation is required of every degree-seeking student entering Shawnee State University. As a first-year student at Shawnee State, you are special to us and we endeavor to

provide information that is critical to being successful in college. The orientation process includes assessment in mathematics, English, and reading for appropriate placement into your initial courses in mathematics and English. You are also advised as to your first quarter classes and registered for those classes.

However, orientation at Shawnee State is more than registering for class. We want you to be successful in the classroom and in your campus life! During orientation, you will learn the academic rules and regulations, but each session is also packed with information regarding critical university services that help you be successful during your collegiate life. These interactive sessions truly orient you to Shawnee State University and give you a chance to ask any questions you may have. The comprehensive student orientation for entering fall quarter freshmen is held during the summer preceding your entry term. If you are entering Shawnee State during winter or spring quarters, we offer a modified orientation program to assist you. For more information, please contact the STARS office at 355-2594.

Placement Testing

All first-time, entering, degree-seeking students must participate in the University's placement testing program prior to registering for English and mathematics courses. If you are entering the University with credits from other colleges or universities, you must participate in the English and mathematics placement testing process if you lack transferable English or mathematics credits.

ACT or SAT scores may be used in place of placement results. If you enter Shawnee State University with an ACT English subscore of 22 or higher, or an SAT English subscore of 520 or higher, you will be permitted to register for ENGL 111S. If you enter with an ACT mathematics subscore of 22 or higher, or an SAT mathematics subscore of 520 or higher, you will be permitted to register for MATH 110S, 130, and/or 150 (including PSYC 150 and SOCI 150).

Note: Students wanting to waive placement testing with ACT/SAT scores must present an "official" ACT/SAT score report at the time of testing, or take it to the Learning Center prior to registering for classes.

For students taking the placements and also later, submitting ACT/SAT scores, ACT/SAT scores will have precedence over any placement results.

If you meet the qualifications for the mathematics portion of the test and wish to register in a mathematics class at a level higher than MATH 130, you must take the Advanced Placement Test. For information about this option, contact the Learning Center.

The placement tests direct you into the university curriculum and ensure that you register for courses that match your level of academic preparedness for college-level coursework. If your placement is not determined by the above criteria, placement testing is mandatory. Placement is determined by test scores and other factors, which are determined by the appropriate division and may include ACT scores and high school background information.

Please contact the Learning Center at (614) 355-2499 or 355-2258 for more information about the English and mathematics placement tests.

Student Advising and Referral Services (STARS)

Student Advising and Referral Services (STARS) is designed to offer advising and referral services to students who need them. STARS also facilitates ongoing retention efforts which allow for University-wide participation of faculty, administration, and staff. The STARS staff work collaboratively with faculty members to provide advising for course sequencing and career goals. STARS also provides advising for students who are considering withdrawal, who wish to reenroll, who desire academic improvement plans, and for any other issues that may be affecting successful completion of educational goals. The student-organized and operated Partnerships for Students is housed in the STARS office and provides activities for students to grow academically, socially, and personally. Students interested in joining Partnerships should contact the STARS office, located on the first floor of the Commons Building. Please call 355-2594 for more information.

Supplemental Instruction (SI)

Selected academic departments offer Supplemental Instruction on an experimental-by course-basis. Facilitated by advanced undergraduates under the direction of a faculty member, SI is intended to help students understand course material presented by faculty and augment in-class activities. Contact the department chairperson for more information, especially in the Department of Mathematical Sciences.

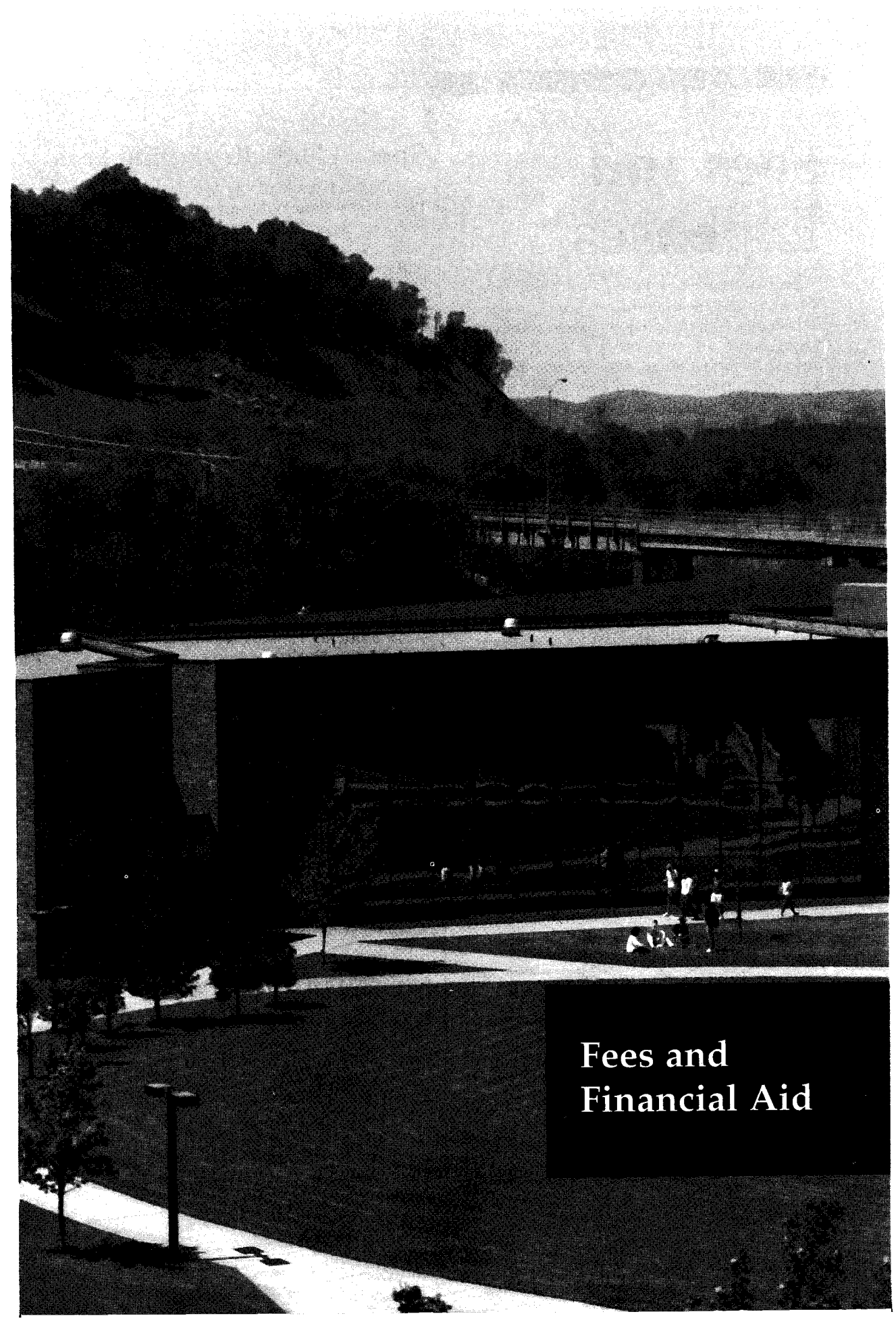

Fees and Financial Aid

Fees and Expenses

Registration fees are payable at the Bursar's Office prior to the opening of classes and in accordance with instructions issued with your quarterly bill. For students registering during late registration, fees are assessed as part of the registration process and are due at that time. If you make changes in your class schedule which result in an increase in your fees, it is your responsibility to go to the Bursar's Office to get a revised bill. No additional bills will be mailed to you as a result of dropping and adding classes.

The Bursar's Office recently moved to the second floor of the University Center. This places it near the Offices of Admission, the Registrar, and Financial Aid and should make it easier for you to—in one place—take care of the "business" of going to college.

Fees may be paid by cash, check, money order, Visa, or MasterCard. It is important that you retain all fee receipts. Payment of fees owed is a prerequisite to official enrollment, and you should have sufficient funds (cash and/or financial aid) to cover expenses.

Student Load

Students scheduled for 12-18 credit hours are considered full-time students. Students scheduled for fewer than 12 credit hours are considered part-time students. The permission of the registrar is required for you to schedule over 18 hours of credit. Please refer to the fee schedule for the rate per credit hour.

Certain students are restricted from carrying a course load greater than twelve hours. These students include first-time entering freshmen placed into two or more developmental education courses and any student placed on academic probation for a second consecutive quarter. A student affected by this policy may appeal to the director of developmental education. In special cases, when this policy would jeopardize a student's participation in a degree program, a department chairperson may also request to waive the twelve-hour limit.

Special Note Regarding Fees

All of the fees listed in this catalog are for the 1996-97 academic year and are subject to change. Shawnee State University reserves the right to make, without prior notice, any fee adjustments that may become necessary.

Quarterly Tuition

Special Note: All out-of-state/in-region students enrolled in health science programs pay the out-of-state fee rather than the out-of-state/in-region fee.

Full-Time Students (12-18 hours)

Instructional Fee

In-State	\$ 815.00
Out-of-State/In-Region <small>(Mason, Lewis, Boyd, and Greenup Counties, Kentucky and Cabel and Wayne Counties, West Virginia)</small>	1,088.00
Out-of-State	1,540.00

General Fee

All Students	142.00
--------------	--------

Technology Fee

All Students	35.00
--------------	-------

Part-Time Students

Instructional Fee (per credit hour, up to 11 and above 18)

In-State	\$ 69.00
Out-of-State/In-Region <small>(Mason, Lewis, Boyd, and Greenup Counties, Kentucky and Cabel and Wayne Counties, West Virginia)</small>	91.00
Out-of-State	129.00

General Fee (per credit hour, up to 11 and above 18)

All Students	12.00
--------------	-------

Technology Fee (per credit hour, up to 11 and above 18)

All Students	3.00
--------------	------

Miscellaneous Student Fees

Application	\$ 30.00
Late Payment	35.00 (max. \$75.00)
<small>(per Budget Payment Plan policy)</small>	
Late Installment Fee	20.00
Budget Payment Plan	15.00
Bad Check Fee	25.00
Transcript	3.00
Transcript, Immediate Action	10.00
Graduation	50.00
Graduation Reapplication Fee	5.00
Credit by Exam	40.00
Credit by Arrangement	(fee per cr. hour) 84.00

Miscellaneous Student Fees (cont'd.)

Change Orders . . . (fee per change, max. \$16.00)	4.00
Credentials Evaluation	50.00
International Student Orientation	200.00
Health Science Fee . . . (per cr. hr., max. \$77.00)	7.00
Education Field Fee	125.00
Lab Fees	see section below

Housing Fees

Double Room annual pmnt.	\$2,625.00
quarterly pmnt. (\$919.00 per)	2,757.00
budget plan (9 payments @ \$315.00)	2,835.00
Private Room (if available) . . . annual pmnt.	3,150.00
quarterly pmnt. (\$1,120.00 per)	3,360.00
budget plan (9 payments @ \$396.67)	3,570.00
Board 17 meals per week	1,188.00

Lab Fees

A current schedule of lab fees is available in the Office of the Registrar. Those fees which exist at the time of this catalog's printing are included with their respective course description, beginning on page 154.

Budget Payment Plan

Shawnee State University provides a Budget Payment Plan that can help you with the payment of tuition, books, and certain fees.

Information about the Budget Payment Plan is available in the Bursar's Office.

Bad Check Policy

Payment of fees owed is a prerequisite to official enrollment, and you should have sufficient funds (cash and/or financial aid) to cover these expenses.

A check returned for insufficient funds is a federal offense and constitutes nonpayment of your obligation to Shawnee State University. Therefore, any student who has a check returned for insufficient funds shall be subject to all related fees, and, until the same is cleared, the student shall be considered in noncompliance with institutional policy and may be administratively dismissed.

Any student administratively dismissed due to a bad check has no recourse for readmission for the current quarter.

Student Insurance

Shawnee State University makes available to all full-time students the benefit of a comprehensive health insurance policy. Full-time students enrolled fall quarter are billed for this insurance for the academic year. If you are covered by other health insurance and you do not want to participate in the student health insurance plan, you should complete the Insurance Waiver Form included with your fall quarter bill and return it promptly to the Bursar's Office. You may also pick up a Student Insurance Program Brochure at the Bursar's Office. Questions concerning student health insurance should be referred to the Bursar's Office.

Refund of Fees

Continuing students dropping hours by change order through the 14th day of the quarter, when such changes result in a reduction of fees, are entitled to receive the reduction. Changes made after the 14th day of the quarter result in no refund.

Students who officially withdraw from Shawnee State receive a refund, if due, based upon the following schedule. If you do not officially withdraw, you are not eligible for any refund and fees assessed are due and payable.

Time of Withdrawal

Regular Term

Through first day of class	100% of Tuition
2 to 7 calendar days	90% of Tuition
8 to 18 calendar days	50% of Tuition
19 to 35 calendar days	25% of Tuition
Over 35 calendar days	No refund

Five-Week Summer Session

Through first day of class	100% of Tuition
2 to 4 calendar days	90% of Tuition
5 to 9 calendar days	50% of Tuition
10 to 18 calendar days	25% of Tuition
Over 18 calendar days	No refund

Please Note: The five-week summer session refund schedule applies to students registered only in a five-week session. If you take classes from both a full summer (ten-week) quarter and a five-week session, refunds are issued under the regular term policy. Questions concerning the above information should be referred to the Bursar's Office.

Students wishing to see examples of these refund calculations may do so in the Financial Aid Office.

Please Note: Refunds for federal Title IV recipients in their first term of attendance at the University are computed through 60 percent of the term according to pro-rata refund guidelines provided by the U.S. Department of Education. Refund amounts for all Title IV recipients are returned to aid accounts or to lenders in a specified order and within time frames mandated by federal regulation. Examples of federal refund calculations are available in the Financial Aid Office.

Late Payment Policy

A late payment fee is assessed when you fail to make payment in accordance with the due dates established by the Bursar's Office. Such fees are assessed in accordance with the fee schedule approved by the University's Board of Trustees.

Miscellaneous Fees

Application Fee

A \$30 nonrefundable application fee must accompany all admission applications.

Transcript Fee

The University will produce an official transcript upon written request from the student at a cost of \$3 per copy. Same day requests for transcripts are processed at a cost of \$10 to the student.

Change Order Fee

A fee of \$4 is assessed for each course change (add/drop) processed, up to a maximum of \$16 per quarter per change order.

Graduation Fee

A \$50 graduation fee is required. You are not billed for this fee. It is your responsibility to pay this when you submit your petition to graduate. Your eligibility to graduate is determined by the registrar after you petition for graduation.

Financial Aid

An extensive financial aid program is available to help you meet the expenses of a college education. The financial aid program is administered by the Financial Aid Office and includes four categories: scholarships, grants, loans, and employment.

Application Procedure

To apply for federal assistance at Shawnee State University, you must complete and submit an original or renewal Free Application for Federal Student Aid (FAFSA) form to the federal processor. Federal aid consists of the Pell Grant, the Supplemental Educational Opportunity Grant (SEOG), College Work Study, Stafford Student Loan, and the Parent Loan for Undergraduates. Forms may be obtained from your high school counselor or the Financial Aid Office at Shawnee State. The FAFSA should be submitted as early as possible beginning in January preceding the academic year.

Transfer students coming directly from a college, technical, business, or proprietary school with no intervening term of absence must submit a **financial aid transcript** from the previous school.

Federal regulations and institutional policies are subject to change without prior notice, but the Financial Aid Office attempts to keep you updated through various media on campus and with written notices. Therefore, it is very important that you update your permanent and local addresses with the Office of the Registrar as necessary. Failure to notify the University of address and name changes can seriously delay your award and can be very costly to you.

Eligibility Requirements

Federal financial aid, Ohio Instructional Grants, and institutional scholarships require that you be fully admitted to a degree program. Federal aid also is available for approved study abroad programs. Federal recipients must have a complete financial aid file, including necessary verification documents and financial aid transcript information, before funds will be awarded.

Federal aid is available to full-time students and, in lesser amounts, to part-time students

taking at least six quarter hours of credit. Eligible students enrolled for a less-than-half-time course load may receive Pell Grant funds. Full-time and part-time Ohio Instructional Grant funds are awarded.

Ohio residents are required to provide documentation of residence, including Selective Service numbers for male students, to the Office of the Registrar. Financial aid will not be disbursed until this requirement is met.

Notification and Disbursement

After your FAFSA needs analysis and other documents have been received and reviewed for accuracy (verified if applicable), you are notified in writing of any award for which you are eligible. If you are denied scholarships or grants, you are encouraged to continue in the process to be considered for supplemental forms of assistance such as loans or employment.

Disbursement dates and procedures vary depending on the type of assistance. Generally, financial aid awards are credited toward your account each quarter. When your grants and scholarships are greater than your university charges, you are issued a refund, in the form of a check, approximately four weeks after the quarter starts and weekly thereafter. Loan balances are returned to you by check after your scheduled disbursement dates.

Scholarships

The Financial Aid Office administers a number of special scholarships for students who demonstrate a high degree of academic ability or special talent. Please contact the Financial Aid Office if you are interested in applying for a scholarship. The deadline for scholarship application is April 1st. Your FAFSA should be submitted by March 1 for need-based scholarship consideration.

Grants

■ **Federal Pell Grant.** Pell Grant funds are awarded based on expected family contribution, enrollment status, and the cost of education.

■ **Federal Supplemental Educational Opportunity Grant (SEOG).** SEOG is a federal grant awarded to undergraduate students on the basis of exceptional financial need beyond the Pell Grant. These funds are limited to the

amount allocated to the University by the U.S. Department of Education. First priority is given to students who complete the FAFSA by March 1.

■ **Ohio Instructional Grant (OIG).** The OIG is a state-funded grant made available to eligible Ohio residents for meeting the cost of education. All Ohio residents who complete the FAFSA will be considered.

Please Note: Under the OIG program, you must be enrolled in an eligible associate or bachelor degree program. Some remedial courses (listed as "099" in this catalog) do not count toward the 12 credit hour requirement. Contact the Financial Aid Office for further clarification.

Student Loans

■ **Federal Subsidized Stafford Student Loan.** The Subsidized Stafford Loan is a federal loan for undergraduate students who demonstrate financial need and who are enrolled at least half-time in an eligible program. **You must complete the FAFSA and the Federal Common Loan form.**

The Federal Subsidized Stafford Loan program is limited to \$2,625 for the freshman year, \$3,500 for the sophomore year, and \$5,500 per year for the junior and senior years. Under this loan program, payment and interest begin 6 months after you stop attending, graduate, or are attending less than half-time (6 hours).

■ **Federal Unsubsidized Stafford Loan.** The Federal Unsubsidized Stafford Loan is a supplemental loan available to dependent or independent students. You are required to apply for the Subsidized Stafford Loan before making application for this loan.

■ **Federal Parent Loan for Undergraduate Students (PLUS).** The Federal PLUS Loan is a supplemental loan for parents of dependent undergraduate students. The borrower may be the natural, adoptive, or step parent; must be a U.S. citizen, U.S. national, or eligible noncitizen; and not be in default on a student loan.

The Federal PLUS Loan must be used for educational expenses at the school the student is or will be attending. Repayment begins in 60 days at a variable interest rate each academic year. The parent borrower is responsible for all interest from the day the loan is disbursed. Checks may be signed by the parent at the Bursar's Office or may be mailed for signature.

Please Note: Loan applications can be obtained from a participating lender or from the Financial Aid Office. First-year, first-time borrowers cannot receive Federal Stafford funds until successful completion of 30 days of their first quarter. If you withdraw from the University, you are not eligible for your next quarter's loan check and you must reapply if you wish to continue receiving student loan funds.

■ **Student Emergency Loan Fund.** The Bursar's Office makes available to students, on a limited basis, small, short-term loans for direct or related educational expenses. These loans are interest free, but if not paid back, your academic records will be placed on administrative hold.

Employment

■ **Federal Work Study (FWS).** The FWS program is available to students who demonstrate financial need through the completion of the FAFSA. All possible attempts are made to place FWS students in positions which coincide with their career interests or academic majors. Community service placements (as defined by federal regulation) are available.

You are paid the current minimum wage and, in most cases, work 10-20 hours per week. You are paid, based on the number of hours worked, every two weeks with the regular university payroll. Funding for FWS is limited; first priority for open positions is given to students who complete the FAFSA by March 1. Indicate on the FAFSA that you are interested in a job.

■ **Student Employment.** Regular student employment is made available to all university students, regardless of financial need, on the basis of current openings. Please contact the Office of Counseling and Career Services for further details.

Veterans, State Programs

Veterans and students receiving assistance through approved state agency programs (Vocational Rehabilitation, JTPA, National Guard, Workers Compensation, etc.) should contact the Financial Aid Office for assistance with course and attendance requirements, tuition payment, and book purchase.

Standards of Satisfactory Progress for Federal Financial Aid for Applicants and Recipients

Federal regulations, published initially in the Federal Register of October 6, 1983, require students to make satisfactory progress toward a degree to be eligible for assistance from the Pell Grant, Supplemental Educational Opportunity Grant, subsidized and unsubsidized Stafford Loans, Parent Loan for Undergraduate Students, and Federal Work-Study.

Such progress is measured in grades (qualitative measure) and hours completed (quantitative measure) at the end of the fall and spring quarters. Changes in federal regulations may require us to modify this policy. All aid recipients are given a copy of the most current policy with their aid award notifications.

Financial Aid Standards of Progress Policy

Grade Point Average (qualitative measure)

Students must meet the grade point average requirements as defined in the "Academic Policies" section of this catalog.

Credit Hours Attempted	Accumulative Grade Average
21-40	.75
41-55	1.00
56-65	1.25
66-75	1.50
76-85	1.75
86 and above	1.90

Credit Hours Completed (quantitative measure)

Bachelor degree students are eligible to receive federal aid through the quarter in which they attempt or earn their 279th credit hour. Associate degree students are eligible to receive federal aid through the quarter in which they attempt or earn their 135th credit hour. Students in approved certificate programs may attempt or earn hours equal to 150 percent of program length.

Students must successfully complete their hours attempted at Shawnee State University according to the following table:

Hours Attempted	Percentage Which Must Be Completed
1-44	60%
45-89	65%
90-134	70%
135-186	75%
187-279	80%

Additional Definitions and Explanations

Attempted: "Cumulative number of hours" are the total hours attempted at Shawnee State University during all enrollment periods, irrespective of receiving financial aid. Students who receive the following grades are considered to have "attempted" those credit hours: withdrawals (WD), incomplete (I), no credit (NC), failure (F), and all passing grades (A,B,C,D,P). Course repetitions (R) count as hours attempted. Total hours attempted may include no more than 45 quarter hours of developmental education credits.

Hours Earned/Hours Passed: Successful completion is measured by the number of "hours earned" recorded on the student's academic transcript at the end of the evaluation period.

Academic Year: For purposes of measurement of progress, academic year is defined as enrollment during any or all of the following quarters: summer, fall, winter, and spring.

Enrollment Status: Federal financial aid recipients must be enrolled in approved degree or certificate programs.

Stafford Student Loans: In addition to the progress requirements listed above, federal regulations require that students progress from one grade level to the next before they are eligible to receive additional loan amounts. In determining the student's grade level, the registrar's definition, as found in this catalog, is used. Students in associate degree programs may be certified for loans only at the freshman and sophomore levels.

Enrollment in a Second Degree: Students seeking federal financial assistance and pursuing a second associate or second bachelor degree must submit a degree audit signed by their academic advisor so that progress within the second program may be measured. This form is also used to determine grade level for federal loan certifications. Maximum levels for Pell Grants and guaranteed loans are observed.

Failure to Maintain Satisfactory Progress

Students who fail the grade (qualitative) portion of the requirement are notified of their probation or dismissal status by the Office of the Registrar.

The first time a student does not complete successfully the hours passed (quantitative measure), he or she is placed on **financial aid probation**. The deficiency must be satisfied in

the next quarter of attendance. The probationary status, for students who continue to have a marginal deficiency at the end of the initial probationary period, may be extended for one additional quarter at the discretion of the financial aid director. If the student does not achieve the required number of credit hours at the end of the probationary, or extended probationary, period, he or she is suspended from financial aid.

Suspension Due to Non-Attendance

Federal regulations require adjustment of financial aid awards for students who do not begin attendance in all classes upon which the awards were based. Adjustments are based on registrar records, including add/drop and withdrawal forms. Students are required to repay adjustment amounts. Students who do not meet repayment terms are suspended from financial aid. (See appeal section.)

Reinstatement of Financial Aid

Unless eligibility is reinstated through appeal, students remain ineligible until that time when they are again in compliance with the standards. It is the responsibility of students seeking reinstatement to request the Financial Aid Office to review their records when they believe they are again in compliance with the requirement.

Appeals

Students may appeal to the director of financial aid. Students must submit a letter explaining the reason(s) for the failure and may be required to submit a degree audit from the student's advisor or other supporting documentation. If the director denies the appeal, the student may request, in writing, that the appeal be reviewed by the Financial Aid Advisory Committee.

Extenuating Circumstances Regarding Appeals

The major acceptable circumstances for making an appeal are the documented personal illness of the student, serious illness or death of an immediate family member (mother, father, sister, brother, husband, wife, child, legal guardian), or enrollment in a bachelor's program requiring more than 186 credit hours or an associate program requiring more than 90 credit hours.

The maximum number of credit hours attempted is considered to be adequate and fair under the progress policy. Change of major field of study, completion of developmental courses, or transfer of credits normally are not considered satisfactory grounds for appeal for additional time, but such appeals may be submitted using the process indicated above.

Unacceptable circumstances for appeals are: continued enrollment while seeking admission to an academic program (i.e., health science) or the prior nonreceipt of Title IV aid since this is irrelevant to maintaining satisfactory progress in the course of study.

Comments about the Progress Requirement

Students are encouraged to work with their academic advisors, the STARS Program, the counseling center staff, and Student Support Services' staff to receive study skills and tutoring assistance.

Students who withdraw from courses after the official add/drop period and students who receive grades of F, W, NC, R, and I greatly increase their potential for failing to meet the progress requirement.

Chart of Hours Attempted/Completed Hours Required to Make Progress

Hours Attempted	Hours Required	Hours Attempted	Hours Required	Hours Attempted	Hours Required	Hours Attempted	Hours Required	Hours Attempted	Hours Required
1	0	57	37	113	79	169	126	225	180
2	1	58	37	114	79	170	127	226	180
3	1	59	38	115	80	171	128	227	181
4	2	60	39	116	81	172	129	228	182
5	3	61	39	117	81	173	129	229	183
6	3	62	40	118	82	174	130	230	184
7	4	63	40	119	83	175	131	231	184
8	4	64	41	120	84	176	132	232	185
9	5	65	42	121	84	177	132	233	186
10	6	66	42	122	85	178	133	234	187
11	6	67	43	123	86	179	134	235	188
12	7	68	44	124	86	180	135	236	189
13	7	69	44	125	87	181	135	237	190
14	8	70	45	126	88	182	136	238	190
15	9	71	46	127	88	183	137	239	191
16	10	72	46	128	89	184	138	240	192
17	10	73	47	129	90	185	138	241	193
18	10	74	48	130	91	186	139	242	194
19	11	75	48	131	91	187	149	243	194
20	12	76	49	132	92	188	150	244	195
21	12	77	50	133	93	189	151	245	196
22	13	78	50	134	93	190	151	246	197
23	13	79	51	135	101	191	152	247	198
24	14	80	52	136	102	192	153	248	198
25	15	81	52	137	102	193	154	249	199
26	15	82	53	138	103	194	155	250	200
27	16	83	53	139	104	195	156	251	201
28	16	84	54	140	105	196	156	252	202
29	17	85	55	141	105	197	157	253	202
30	18	86	55	142	106	198	158	254	203
31	18	87	56	143	107	199	159	255	204
32	19	88	57	144	108	200	160	256	205
33	19	89	57	145	108	201	160	257	206
34	20	90	63	146	109	202	161	258	206
35	21	91	63	147	111	203	162	259	207
36	21	92	64	148	111	204	163	260	208
37	22	93	65	149	111	205	164	261	209
38	22	94	65	150	112	206	164	262	210
39	23	95	66	151	113	207	165	263	210
40	24	96	67	152	114	208	166	264	211
41	24	97	67	153	114	209	167	265	212
42	25	98	68	154	115	210	168	266	213
43	25	99	69	155	116	211	168	267	214
44	26	100	70	156	117	212	169	268	214
45	29	101	70	157	117	213	170	269	215
46	29	102	71	158	118	214	171	270	216
47	30	103	72	159	119	215	172	271	217
48	31	104	72	160	120	216	172	272	218
49	31	105	73	161	120	217	173	273	218
50	32	106	74	162	121	218	174	274	219
51	33	107	74	163	122	219	175	275	220
52	33	108	75	164	123	220	176	276	221
53	34	109	76	165	123	221	176	277	222
54	35	110	77	166	124	222	177	278	222
55	35	111	77	167	125	223	178	279	223
56	36	112	78	168	126	224	179		

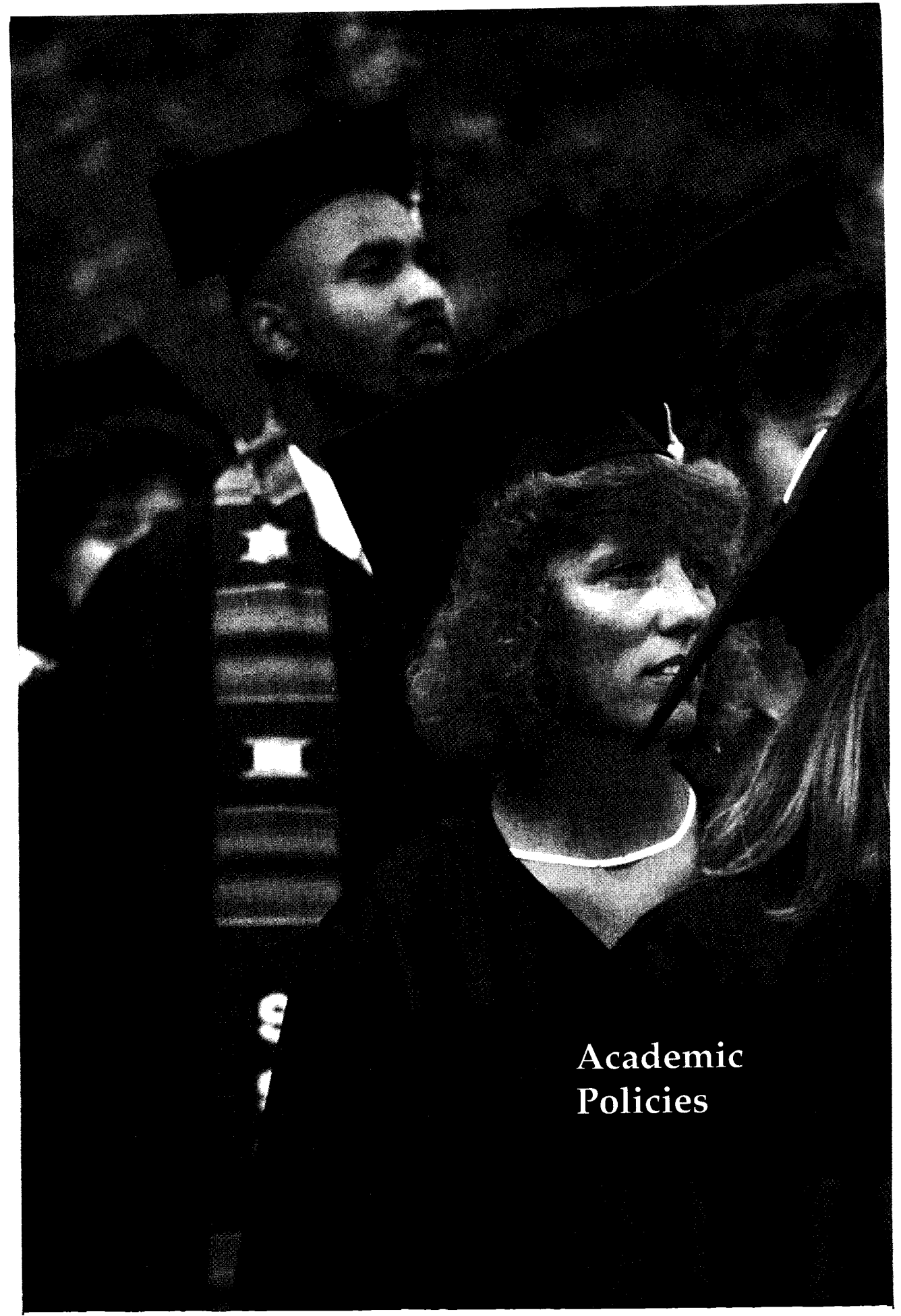

Academic
Policies

Academic Programs and Policies

Academic Integrity

Students at Shawnee State University are required to do their own work on all tests and assignments. Any form of cheating may result in your being withdrawn from a particular course or courses, as well as possible dismissal from the University. (See Student Handbook.)

Grading/Awarding of Credit

Final grades are mailed at the end of each quarter by the Office of the Registrar. Grades will not be issued orally.

Grade	Description	Quality Points
A	Excellent	4.00
A-	3.67
B+	3.33
B	Good	3.00
B-	2.67
C+	2.33
C	Average	2.00
C-	1.67
D+	1.33
D	Poor	1.00
D-	0.67
F	Failing	0.00
TC	Transfer Credit	0.00
KE	Credit by Exam	0.00
NC	No Credit	0.00
WD	Withdrawal	0.00
I	Incomplete	0.00
P	Pass	0.00
AP	Advanced Placement	0.00
AU	Audit	0.00
NR	No Report	0.00

A grade of "F" receives no credit. Students making this grade must repeat the course if credit is to be received.

Class Ranking

Student class ranking is determined by your cumulative credit hours earned and your degree program (please note the following chart). Non-degree seeking students do not possess class rank.

Degree Program	Class Rank	Cumulative Hrs. Earned
Associate	Freshman	0 - 44
Associate	Sophomore	45 - no upper limit
Baccalaureate	Freshman	0 - 44
Baccalaureate	Sophomore	45 - 89
Baccalaureate	Junior	90 - 134
Baccalaureate	Senior	135 - no upper limit

Incomplete Grades

If you are unable to attend class for an extended period of time, you may contact the faculty member responsible for the class to request an incomplete grade. Incompletes must be converted to a grade 30 calendar days into the next quarter or they are recorded as "F's."

Administrative Hold

With the approval of the registrar, an administrative hold may be placed on the records or accounts of any student who fails to comply in a reasonable period of time with an obligation imposed under university rules or who has an overdue debt or fine. An administrative hold will cause certain services to be withheld, including, but not limited to: obtaining current quarter grades, registering or enrolling, being certified as eligible to obtain a degree or certificate, receiving a transcript, borrowing books or equipment, or being certified to be eligible to participate in athletics.

The unit originating an administrative hold on your records or accounts will notify you in writing of the obligation that is overdue by providing another itemized bill or list of action requested, specifying when the administrative hold will become effective, whom you should contact for additional information, and how you should contact this person.

Any disputes concerning the legitimacy of the hold or its processing will be resolved by the registrar.

Academic Assessment

The value of an educational degree is directly related to the reputation of the university that awards it. For this reason, students on our campus are given the unique opportunity to actively participate in academic assessment. The feedback provided through assessment

leads to changes that assure and maintain the quality and value of the academic programs at Shawnee State University.

Formal assessment testing, portfolio review, surveys, and exit interviews allow the University to assess the strengths and weaknesses of our programs. And, for all its benefits, the process actually requires a minimal amount of your time.

All students—except for those classified as special nondegree students (see page 21 of this catalog)—are required to complete the Academic Profile twice. The first time is during your first quarter—before your grades are issued—and the second time is prior to your graduation. Special nondegree students are not required to participate. Please note: the Academic Profile is **not** the same test as Placement Testing (see page 27).

If you are completing your degree or certificate or if you are enrolled in Senior Seminar during the 1997-98 academic year, you must complete the Academic Profile in order to receive your degree or certificate.

By measuring what you've learned as well as what you can do with what you've learned, assessment helps you monitor your own progress, and it leads to changes that benefit future Shawnee State students and the University as a whole.

Dean's List/President's List

Full-time students (12 or more hours per quarter) who achieve a 3.5 to 3.99 grade point average are placed on the Dean's List for that quarter. Full-time students who achieve a 4.00 grade point average are placed on the President's List for that quarter.

Pass/No-Credit Policy

The pass/no-credit option is designed to permit you to take a select number of courses for which no traditional letter grade (of "A" through "F") is recorded on your grade report and transcript. If you wish to take a course on a pass/no-credit basis, you must complete the proper forms at the registrar's office within the first 14 calendar days of a regular quarter or the first 7 calendar days of a 5-week term. Your decision to take a class on a pass/no-credit basis is not subject to change.

To be eligible for the pass/no-credit option, you must have earned a cumulative G.P.A. of

2.0 or better. First quarter freshmen are considered as having met the above requirement.

The pass/no-credit option is subject to the following restrictions:

- You may complete up to 8 quarter hours to be counted toward an associate degree or 16 quarter hours to be counted toward a baccalaureate degree under this option.
- You may take only one (1) course pass/no-credit per quarter.
- Applicability of courses taken pass/no-credit toward your major program of study is subject to departmental approval.
- To receive a grade of P (pass), you must earn a grade of C- or better in the course. If you do not receive a grade of C- or better, a grade of NC (no credit) is awarded.
- A grade will be turned in at the regular grade-processing time and will be converted to a P or NC on the transcript by the Office of the Registrar.

Credit by Examination

Students have the opportunity to earn credit for selected courses offered at Shawnee State University via proficiency examinations. If you have prior training, innate skills, extensive preparation, or experience, you may qualify to attempt the examination. You should first secure the advice of your advisor or program director as to its appropriateness for your program of study. Then, final approval must be obtained from the appropriate chairperson, program director, or dean. Please note that only selected courses are available "by examination."

A fee of \$40 is charged for course credit by examination and must be submitted prior to attempting the examination. A "KE" symbol, indicating "credit by exam," is recorded on the academic transcript of those students who demonstrate proficiency by passing the exam. Credit earned by examination is not included in the calculation of your cumulative grade point ratio. You are not eligible to attempt a proficiency examination for a course in which you have been enrolled for 20 class days or more.

Credit hours awarded by examination do not apply toward the residency requirement for graduation.

College Level Examination Program (CLEP)

Students may be awarded credit for College Level Examinations taken under the College Entrance Examination Board. If you take the general examinations in English composition, mathematics, natural sciences, humanities, social sciences, and history and achieve the recommended scores of the Commission on Educational Credit and Credentials of the American Council on Education (ACE), you are given "KE" credit for the first sequential course in the above areas.

Many subject examinations may be used to earn "KE" credit for courses in the same subject areas, but you must achieve recommended ACE scores to receive credit.

Credit given through the College Level Examination Program does not apply toward the residency requirement for graduation.

Credit for Military Educational Experiences

Credit may be awarded for military educational experiences. The Guide to the Evaluation of Educational Experiences in the Armed Forces, published by the American Council on Education, is used to determine possible college credit eligibility. Credit awarded for military educational experiences does not apply toward the residency requirement for graduation. Please contact the Office of Transfer Placement for more information.

Prerequisites

Most learning beyond basic skills is dependent upon the mastery of some prior skill or subject content. As a result, many courses at the University require the satisfaction of prerequisites prior to course enrollment. Prerequisites may be met by successful completion of the prior courses listed or by placement, via testing, into the course.

The academic division/school may withdraw a student from a course for which prerequisites have not been satisfied.

Repeating Coursework

Courses may be repeated for credit if so identified in the course description located elsewhere in this catalog. Courses may also be repeated for other purposes (e.g., attempt to raise grade), but only the highest grade earned and the associated credit will be reflected in your GPA (grade point average). The lower course grade will be replaced by the symbol "R," indicating the course was repeated.

While most courses are eligible for repetition, the following transcript symbols cannot be removed by subsequent course repetition: WD, AP, P, KE, NC, AU, TC (please note Grading/Awarding of Credit section on page 38 of this catalog).

Changing Grades

If you question a grade in a particular course, you must contact the faculty member responsible for that class.

Grade Point Average

Quality points for a course are determined by multiplying the total credit hours by the numerical equivalent of the letter grade received in the course. The formula for calculating grade point average is:

$$\frac{\text{Total Quality Points}}{\text{Total Hours Attempted}} = \text{Grade Point Average}$$

Academic Probation

If you achieve a grade point average of 1.5 or less for any quarter, you are placed on academic probation for the following quarter provided your cumulative grade average does not fall below that required to remain enrolled. (See the following academic dismissal section.)

Academic Dismissal

Students are academically dismissed when their cumulative grade average falls below:

Credit Hrs. Attempted	21-40	41-55	56-65
Cumulative G.P.A.	0.75 or below	1.00 or below	1.25 or below

Credit Hrs. Attempted	66-75	76-85	86+
Cumulative G.P.A.	1.50 or below	1.75 or below	1.90 or below

Students academically dismissed are eligible to reenroll after one quarter.

Academic dismissal may affect Title IV student financial aid funds. Please check the financial aid "Satisfactory Academic Progress" charts (on pages 34 and 36 of this catalog) for further information.

Non-Credit (Audit)

You may elect to take a course for non-credit (audit) during the first 35 class days of a quarter (17 days of the 5-week summer sessions) by completing the proper forms in the Office of the Registrar. Election of this option may affect federal financial aid eligibility.

Course Credit by Arrangement

Students have the opportunity to fulfill requirements for selected courses offered at Shawnee State University via independent study or specially arranged instruction. If you are interested in pursuing this educational option, you should first secure the advice of your faculty advisor as to its appropriateness for your program of study. You should then contact the appropriate dean, director, or chairperson. This individual, after consultation with appropriate faculty, makes a determination as to the feasibility of your request. You may earn up to 18 credit hours toward graduation in this manner, with all credit being considered resident credit, but you are limited to eight hours of credit by arrangement per quarter. Students enrolling in a course by arrangement have until the date grades are due the following quarter to have all work completed in the course.

Credit hours attempted/earned via this option do not count toward full-time student status except in the computation of federal financial aid eligibility. See the fee schedule for course by arrangement fees. All fees must be paid prior to the beginning of the course.

Honors Program

The Shawnee State University Honors Program is designed for students with exceptional academic and creative abilities. The program,

besides providing recognition to the bright and highly motivated, gives talented students the opportunity to interact with their peers and faculty in a challenging and supportive environment. The Honors Program enriches student life in three ways:

■ **Honors Classes.** The Honors Program offers a small number of honors seminars, colloquia, sections of standard classes, and "directed readings" courses on the main campus. (With the consent of the instructor, these honors courses are also open to non-honors students.)

■ **Honors Advisement.** The Honors Program provides special, supplementary academic advisement on an ex officio basis. The advisement offers scheduling assistance and provides information on graduate and professional schools.

■ **Other Activities.** The Honors Program arranges, for its students, special activities that are both academic and social in nature.

Honors Program Admission Policy. Membership of the Shawnee State University Honors Program represents approximately the top three percent of the full-time student population. Selection is based on a multi-dimensional rating scale, including (but not limited to) accumulative grade point average and ACT/SAT scores.

Requirements for Honors Students. Honors students graduating with a 3.75 accumulative grade point average (or better) who have completed a minimum of 24 credit hours of honors courses (12 credit hours in the case of a two-year degree) graduate with a special "Honors Program Certification." This certification is indicated on your academic transcript.

Further information about the Honors Program may be obtained from the Office of the Provost, (614) 355-2472.

Internship Guidelines

Guidelines for internship have been established by faculty for those programs which require internship as part of their graduation requirements. If internship is a part of the program in which you are enrolled, you are urged to request a copy of the guidelines from your faculty advisor.

International Study Programs

The University encourages and promotes the development of intercultural and multicultural academic pursuits of all Shawnee State students. To give you an opportunity to broaden your foreign study experience, the University periodically sponsors international awareness and exchange programs, as well as travel and language study abroad.

Shawnee State also takes great pride in the international faculty who teach at the University. These faculty, and the students we welcome from other countries, share their international perspectives every day and enrich the lives of everyone in the Shawnee State academic community.

International programs at Shawnee State may take many forms: summer courses taught by university faculty, courses at foreign educational institutions, field studies, and, periodically, student exchange programs. The University annually sponsors an International Awareness Week and occasionally hosts Visiting Fulbright Scholars and lecturers. In order for you to benefit from a variety of international study options, Shawnee State University has also established a sister-institution agreement with Nizhny Novgorod State University in Russia, with the Zhejiang University of Technology in China, and others are being explored with universities in Spain, Germany, and England.

If you are interested in an international exchange opportunity, you should plan early, consulting first with your faculty advisor and then with Dr. Hagop S. Pambookian, International Program Committee representative.

Study opportunities may also be available in cooperation with the city of Portsmouth, which is a sister city to Orizaba, Mexico; Zittau, Germany; and Corby, England.

Faculty Advising

Academic advising is provided to degree-seeking students by faculty advisors. The purpose of faculty advisement is to help you with your immediate academic concerns. Faculty members will meet with you by appointment, and each faculty member has available hours posted near his or her office.

Faculty Expectations and Responsibilities

Faculty expect regular and punctual attendance at all classes. Attendance policy for individual classes is made by the faculty member responsible for the class. Grades are also controlled by the faculty member responsible for the class.

In the event that a faculty member is not present at the normal time class begins, you are to remain in the classroom an additional 15 minutes. If the class meets once a week for 3 to 5 hours, you must remain in the classroom for 45 minutes. If the faculty member has not arrived or no special instructions have been received within that time, you may leave class without penalty.

All faculty members post office hours during which they are available to discuss individual problems relating to your academic progress. You are encouraged to take full advantage of your academic advisors. They want to see you succeed.

Visitors to Class

Students planning to bring a visitor to a class with them are asked to obtain the permission of the faculty member responsible for the class in advance of the visit.

Bringing Children to or Leaving Children at the University

Children are welcome at the University, with you, at any family event. However, please do not bring children to the University and leave them unattended while you are in class or at another university-related event. The University cannot be responsible for children who are left unattended.

Adding a Class

You may add a class to your schedule during the first five class days of the quarter (five days of a five-week summer session) by completing a change order in the Office of the Registrar. A fee is assessed for each change.

Dropping a Class

You may withdraw from a class through the 14th calendar day of the quarter by completing a change order form in the Office of the Registrar and paying the appropriate fees. During the first 14 calendar days, if class withdrawal affects fees, a refund is possible. Any withdrawal after the 14th calendar day results in a WD being placed on your academic record. Withdrawing from courses may affect Title IV student financial aid funds. Please read the Financial Aid Satisfactory Progress section on pages 34 and 36 of this catalog.

You may withdraw from a class the 15th through 49th calendar days of the quarter by obtaining the signature of the instructor on a form obtained from the Office of the Registrar. Appropriate fees must be paid and the form returned to the Office of the Registrar.

In case of emergency, as determined by the Office of the Provost, you may withdraw from a class after the 49th calendar day, but no later than 5:00 p.m. on the final day of class, by obtaining permission from the Office of the Provost, paying appropriate fees, and completing appropriate forms. Faculty members are notified by the Office of the Provost of these emergency withdrawals.

Withdrawing from College

Should your circumstances warrant a complete withdrawal from the University, you must contact the Office of the Registrar to complete the proper forms. The staff will direct you to the STARS office where proper information is given regarding the possible academic and financial aid ramifications of complete withdrawal. Many times, staff in the STARS office can provide alternatives so that departure can be avoided. It is never advisable to withdraw from the University without first speaking to a representative from STARS. Additionally, reentry into the University is made more convenient for you by STARS staff. You will automatically receive subsequent quarter schedules with an invitation to register.

Grades for scheduled classes are recorded as withdrawals (WD). See the fee schedule for our refund policy.

If you do not follow the withdrawal procedure, you are considered enrolled in the class and are graded accordingly.

Transcripts/Grade Reports

Each quarter you receive a grade report that includes grades achieved that quarter. Please contact the registrar within 30 days of receiving the grade report if you discover an error.

You may request transcripts from the Office of the Registrar. Requests for official transcripts must be in writing and addressed to the Office of the Registrar. The transcript fee is \$3.

Graduation Requirements

In addition to the specific requirements listed by the individual divisions, the following are general graduation requirements for all students at Shawnee State University:

- A minimum of 186 credit hours, including the 48 credit hours of the General Education Program.
- A minimum of a 2.0 cumulative grade point average for all courses taken at Shawnee State University and in your major field of study.
- Completion of at least 45 credit hours at Shawnee State University, of which 35 credit hours must be upper-division courses (300-400 level courses).
- A minimum of 60 credit hours in the major field of study.
- Petition for graduation in accordance with the rules prescribed by the University.
- Receive recommendations of faculty in academic major.

Students having outstanding institutional bills or notes are not issued a degree. All students are required to earn a minimum 30 hours of credit for the associate degree and 45 hours for the baccalaureate at Shawnee State University in order to be eligible for graduation. You must petition to graduate by the deadline published in the calendar. Petitions are available in the Office of the Registrar.

Please Note: Students in health science majors must be in good standing in order to graduate.

Graduation with Honors

■ **Students entering SSU prior to the 1997-98 academic year.** Students who achieve a cumulative grade point average of 3.25-3.49 prior to the quarter of graduation are graduated

cum laude. Students who have achieved a cumulative grade point average of 3.50-3.74 prior to the quarter of graduation are graduated magna cum laude. Students who achieve a cumulative grade point average of 3.75 or above prior to the quarter of graduation are graduated summa cum laude.

■ **Students entering SSU during the 1997-98 academic year and thereafter.** Students who achieve a cumulative grade point average of 3.5-3.74 prior to the quarter of graduation are graduated cum laude. Students who have achieved a cumulative grade point average of 3.75-3.89 prior to the quarter of graduation are graduated magna cum laude. Students who achieve a cumulative grade point average of 3.9 or above prior to the quarter of graduation are graduated summa cum laude.

Developmental Education

If you lack college-level academic skills in basic English, mathematics, or science, you may choose or be advised to take developmental courses in these areas. Furthermore, in instances where placement test outcomes indicate an explicit need for college preparatory coursework, you are required to take certain developmental courses before registering for some university courses.

Developmental courses provide under-prepared students an opportunity to gain the skills and knowledge necessary to attempt college-level coursework. They are intended for students who have had no background in a subject (e.g., biology and physics), inadequate preparation in a subject (e.g., mathematics, writing, reading), or have been away from school and need review. Credit hours earned in developmental courses, excluding UNIV 101 and 102, cannot apply toward degree requirements.

The Department of Developmental Education offers the following courses. Their descriptions are found in the "Course Description" section of this catalog, beginning on page 154.

BIOL 099	Fundamental Biology
ENGL 095	Basic Writing 1: Mechanics
ENGL 097	Reading Development 1
ENGL 098	Reading Development 2
ENGL 099	Basic Writing 2: Parag. and Essays

MATH 099	Fundamental Mathematics
PHYS 099	Fundamental Physics
UNIV 101	Academic Development Skills
UNIV 102	Personal Development Skills

The Learning Center, which houses the Department of Developmental Education, is located in Massie Hall and is best described as a help center. Students usually seek the assistance of the Center's personnel, programs, and equipment when they need extra help preparing for class. The Center offers a variety of services to Shawnee State students.

Tutoring

One of the most popular Learning Center programs is the tutoring program. If you need help understanding course concepts or completing course assignments, you may request the assistance of a peer tutor, another student who has proven competent in a subject and has volunteered to help other students taking a course in the subject.

Equipment and Services

The Learning Center provides many types of instructional technology for use by individual students. These include typewriters, slide projectors, videotape recorder/players, audiotape recorder/players, and filmstrip projectors. Also very popular with Shawnee State students are the microcomputers and instructional software available in the Center. In fact, the Learning Center houses the University's largest open microcomputer laboratory.

Many of the University's learning assistance programs have their home in the Learning Center. These include the Department of Developmental Education, the Academic Placement Program, the Peer Tutoring Program, and Shawnee BASICS (Basic Adult Skills in a College Setting).

Library

Opened in 1991, but designed for the 21st Century, the Shawnee State University Library, a charter member of OhioLINK, offers high tech library options in relaxed, friendly surroundings. Comfortable seating for reading and study, small conference rooms for group work, seminar rooms with satellite downlinks

for teleconferencing and other distance learning activities, and a 350-seat lecture hall provide for a diverse range of student needs.

Reference and Information Counter staff are always present and ready to personally assist any student who wants help locating information or using the Library's resources.

Electronic catalogs and research databases, accessible in the Library or in computer labs across campus, can also be reached by modem or via the Internet from homes, schools, and businesses across the region.

Multimedia, audiovisual materials, and media production facilities complement the traditional print collections. To supplement local cataloged resources, students can order, electronically and at no cost, virtually any of the 14 million items available in the OhioLINK system. An intercampus circuit of pickup and delivery assures that items requested electronically from other campuses will be available for checkout at the University Library Circulation Counter within 3 working days. Full-text magazine, journal, and newspaper articles, available via several research databases and Internet services, augment the Library's periodical collection. And, as a member of the U.S. Government Depository program, the University Library also provides not only government documents in print but also access to many restricted government resources on the Web.

PC and Macintosh computer workstations, loaded with software for wordprocessing/spreadsheets/databases, presentation packages, student email, and Web connectivity, allow students the opportunity to accomplish many different activities within the Library. Workstations equipped with oversize monitors, video magnifiers, speech synthesizers, and adaptive keyboards are also available.

A leader in the electronic revolution on the Shawnee State campus, the Library welcomes students to join the action on the Information SuperHighway.

Continuing Education

Shawnee State University is committed to serving the educational needs of learners of all ages. Through the Office of Continuing Education, the doors of educational opportunity are

open to approximately 7,000 lifelong learners annually. An array of credit and non-credit instructional programs are geared to meet a wide range of interests, abilities, and objectives.

Continuing Education works with business, industry, social agencies, and organizations to develop quality programs to help individuals pursue career endeavors and satisfy professional training needs. Each year the interest of youth is broadened through sport and academic camps for the talented and gifted. In an effort to serve special interest groups, the Office of Continuing Education has actively pursued grants funding and developed programs for displaced workers, small business owners, economically disadvantaged youth, and senior citizens.

For further information about course schedules or program development, contact the Office of Continuing Education.

Special Programs and Community Services

Through the Office of Continuing Education, learners of all ages have multiple opportunities for enrichment. *Community service classes*, ranging from financial planning to crafts and travel are offered throughout the year. *Winter and Summer Enrichment* provide unique educational experiences for area elementary school students. Enrichment classes are designed and taught by teachers and other community members who are willing to share a special skill or interest with children.

Special programs are also designed around the needs of specific groups. *Career Exploration for Women* hosts over 1,000 junior-high aged girls each year, giving them exposure to a variety of fields and career options. Professionals from a wide range of occupations present information about their careers and the education each requires in this half-day workshop. *The Ohio Academic Competition's* southeast regional tournament is hosted each spring by the Office of Continuing Education. About twenty teams from high schools in the southeast quadrant of Ohio compete in this academic challenge bowl hoping to earn the right to compete in the state finals. Over 5,000 children and adults attend performances of *The Nutcracker* ballet each Christmas, performed by a local dance studio and coordinated by C.E. *The Governor's Summer Institute* is one of the two largest Ohio summer institutes for talented and gifted high school students. Each year, approximately 200 students from all parts of Ohio are challenged by G.S.I.'s

classroom activities and stimulated by the accompanying activities. *Elderhostel* provides enrichment experiences for learners over 55. Senior citizens from all parts of the country spend a week at SSU, becoming acquainted with the local culture and taking part in specially designed classes. *Professional development* in a variety of fields is offered throughout the year. The Office of Continuing Education can custom design workshops and seminars to assist professionals in maintaining certification or simply enriching their knowledge within their discipline. Continuing Education Units or course credit can also be arranged upon request.

Computer Proficiency Training

Community members interested in honing their computer skills in a non-credit setting may enroll in a variety of proficiency classes. New classes begin quarterly, offering training on many of the popular software packages including Microsoft Works and Office, Windows, Word Perfect, Internet, and desktop publishing programs, among others. Training sessions designed specifically for a group or organization are also scheduled as needed.

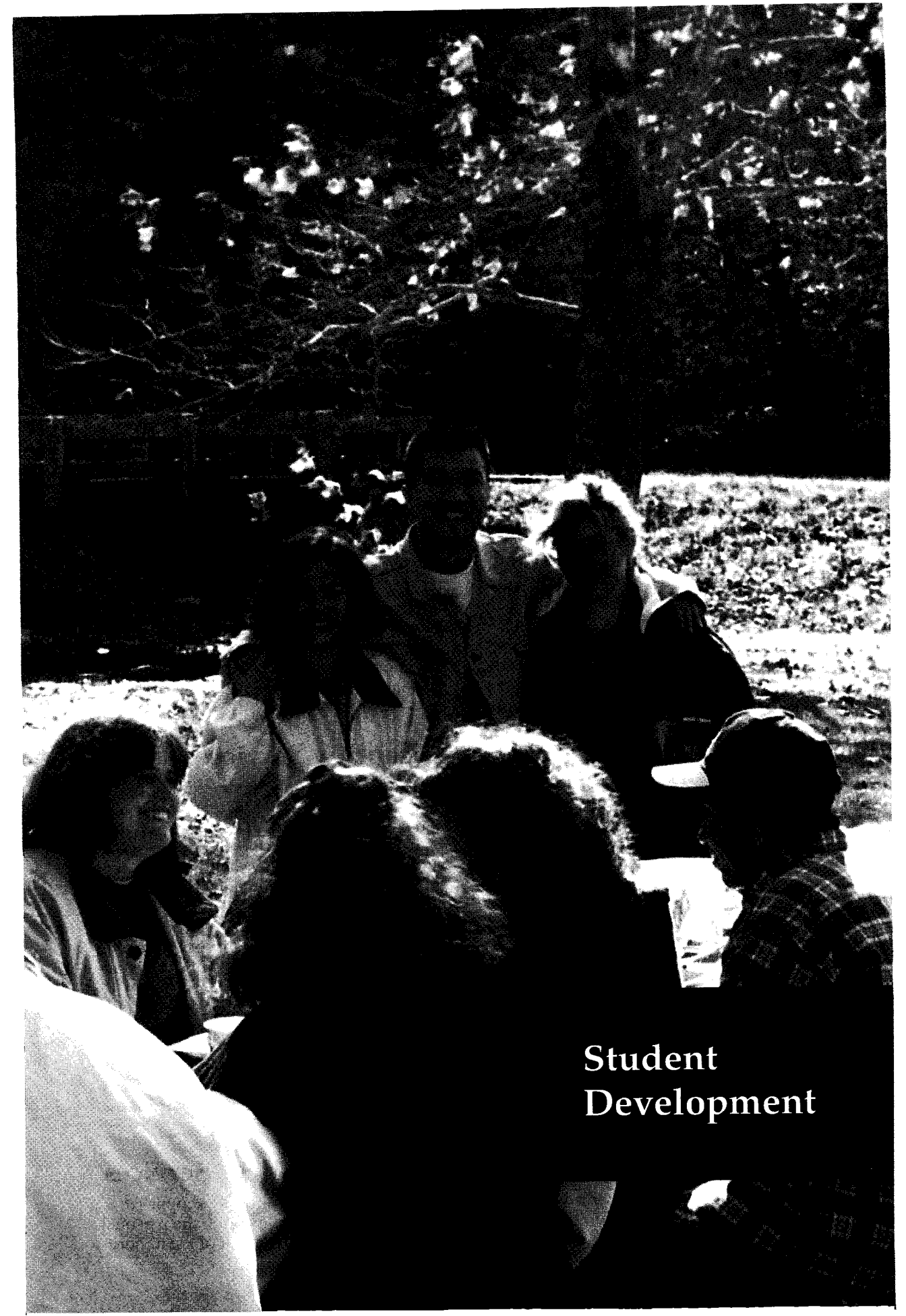

**Student
Development**

Counseling

The University provides a variety of counseling services through the different offices of Student Affairs. Admission, placement, financial aid, veteran's, educational, and vocational counseling are available to you free of charge.

Counseling and Psychological Services

The counseling center offers programs which meet your personal and developmental needs and enhance your growth. Typically, services are provided to students who are experiencing short-term, situational, or crisis-oriented personal concerns which interfere with their academic progress or personal life. These services are provided through individual, group, and couple counseling. Assessment and evaluation services are also available, as well as specialized, skills development group programs. The center also offers referral services to other professionals and agencies in the community. All services are confidential.

The counseling center is located on the first floor of the Commons Building, and you are welcome to walk in or call the Center at (614) 355-2213. The center is open Monday through Friday, 8:00 a.m. to 5:00 p.m., and selected evenings and other times by appointment.

Career Planning and Placement Services

Counseling provided through Career Services can help you deal with a number of career-related issues as well as help you select a major if you're undecided.

Staff maintain extensive contacts on and off campus which can help you secure employment, either while you're enrolled at the University or after graduation. They will help you develop job search, interviewing, resume, and cover letter writing skills which you can use as you seek employment. Career Services' annual Job Fair is held every February. It gives you the opportunity to meet and interview with representatives from business, industry, educational, and health care organizations.

Career Services will also help you apply to graduate or professional school.

You are encouraged to take full advantage of these services, which are available to students, staff, and alumni of the University at no charge. The office is located on the first floor of the Commons Building and may be reached at 355-2213. The office is open Monday through Friday, 8:00 a.m. to 5:00 p.m., and selected evenings and other times by appointment.

International Student Services

The Department of Educational Needs Services offers a variety of supportive services to enhance the personal and intellectual opportunities of Shawnee State's international students. Special programs and activities are available to ease your transition into campus life, including social and cultural opportunities which expose all students to cultural diversity and contribute to their educational development. The office is located in the Commons Building, and more information can be obtained by calling 355-2276 or 355-2442.

Disability Services

Shawnee State provides special support to all disabled students. A full range of services and equipment is available, and an individual plan of support is developed for each disabled student, particularly those who are identified as learning disabled. Documentation of your specific disability is required and placed on file in this office prior to the start of your classes.

If you are physically challenged, you are encouraged to register with the Department of Educational Needs Services. The staff are dedicated to helping make your college experience successful.

The brochure *Do It* provides a complete description of services offered. You may obtain a copy by visiting the office, in the Commons Building, or by calling 355-2276 or 355-2442.

Minority Student Services

A wide variety of culturally supportive services and programs enhance the personal and intellectual development of the minority

student at Shawnee State University. Included are peer tutoring and mentoring programs, leadership training, community service, and social activities.

Information about minority scholarships, minority employment, minority sororities and fraternities, educational opportunities, and more is available by contacting the office, in the Commons Building. The phone number is 355-2276 or 355-2442.

Student Advising and Referral Services (STARS)

Student Advising and Referral Services (STARS) provides counseling services for students who have academic and/or personal issues that may be interfering with their learning experience. STARS is located in the Commons Building and has office hours Monday through Friday, 8:00 a.m. to 5:00 p.m., and evenings by appointment. Please call 355-2594 for more information.

The Connection

The JOBS Student Retention Program helps ADC and JOBS recipients become emotionally independent and academically successful students. JOBS counselors make every effort to help you overcome any barrier that stands between you and the completion of a college degree, whether that barrier is social, economic, or academic.

The program is divided into several parts. First, services are provided the quarter before you enroll at Shawnee State to help you prepare for a successful academic experience. Second, currently enrolled students can benefit from ongoing and individualized services, such as the purchase of texts and uniforms needed for a particular course or a summer school scholarship.

Please contact The Connection, located at 25 Union Street, for more information. The telephone number is 353-6400.

Student Support Services

Student Support Services, funded through a grant from the U.S. Department of Education, offers a variety of assistance to a limited number of qualified Shawnee State students. To qualify for the program, you must meet low income guidelines or be a first generation college student or have a documented physical or learning disability.

A short application form and a conference with program staff are required, but once you are accepted into the program, the following services are available:

- Academic Assistance: Advising (help with course planning and selection); review of basic grammar, writing, and study skills; peer tutoring
- Assessment: Career decision making
- Personal Assistance: Personal and career counseling
- Cultural Experiences

Student Support Services is located in the Trio Center on the first floor of the Commons Building, and the office is open Monday through Friday from 8:00 a.m. to 5:00 p.m. Evening appointments are also available if that is more convenient. Please call (614) 355-2444 for further information.

Athletics

Shawnee State University's philosophy holds that there is more to learning than academics. Besides attending classes, every student has the opportunity to participate in recreational or athletic activities, which at Shawnee State are intercollegiate, intramural, or individual in nature. You may review the annual report disclosing "Equity in Athletics," which is available in the athletic office and the office of the Vice President for Student Affairs.

Intercollegiate Athletics

Intercollegiate athletics at Shawnee State University promotes the education and development of student athletes through athletic participation. The athletic department

shares the University's commitment to high standards and embraces the concept of the student athlete. Educational development is the central focus of the department.

We believe that a learning experience isn't confined to the classroom or laboratory, but is a combination of your total college experience. That's why our athletic program is viewed as a cocurricular activity and, as such, is considered an educational experience. Students are involved in our athletic programs as student athletes, student assistant coaches, statisticians, trainers, managers, cheerleaders, and ushers. The goal of the Shawnee State Athletic Department is to insure that the intercollegiate athletic experience is one from which our students can learn and grow.

Athletic policies at Shawnee State conform to the National Association of Intercollegiate Athletics (NAIA). Currently, Shawnee State fields teams in men's and women's basketball and cross country; men's soccer, golf, and baseball; and women's volleyball, softball, and tennis. Shawnee State University also fields junior varsity teams in men's basketball, baseball, and soccer and women's volleyball. The University's intercollegiate athletic teams are affiliated with the Mid-Ohio Conference (MOC).

Shawnee State will expand its intercollegiate program in the 2000-2001 academic year with the addition of football and three women's sports. At that time, all sports will become non-scholarship, and the University will apply for membership to the NCAA.

Intramural Sports

Competitive sports and recreational activities are a desirable part of your educational program. Through participation, you develop an appreciation of the worthy use of leisure time and a wholesome attitude toward physical activity.

The Intramural Department conducts activities of interest to the men and women of Shawnee State University. The department's goal is to provide an opportunity for every individual to participate in some activity of his or her own choosing. Intramural activities are organized on a team and individual basis so that everyone can participate. Ability is not the issue; the only requirement is a desire to participate.

Student Activities

Shawnee State University is dedicated to the principle that many valuable experiences should be provided for college students outside the academic area. The Office of Student Activities encourages you to share your ideas—and then, to help develop the programs that enrich the lives of Shawnee State's students.

Student activities are a good way for you to meet new friends, develop new interests and skills, and participate in valuable leadership experiences.

Many clubs and organizations are sponsored by the office, including the Student Senate, the Student Programming Board, Greek organizations, and the student newspaper. If you would like information about an existing club or organization or if you're interested in starting a new activity, please contact the director in the Office of Student Activities.

Identification Cards

Identification cards are issued to Shawnee State University students by the Office of the Registrar and are the means of identification necessary for using the Library and participating in student activities. You must present evidence of registration when you receive your I.D. card, and validation of the I.D. is required each quarter at registration.

Bookstore

The Shawnee State University Bookstore is owned and operated by the University for the convenience of students, faculty, and staff. The main purpose of the Bookstore is to provide the textbooks and supplies necessary to complete required coursework. In addition, items such as calculators, computer supplies, swimming and racquetball equipment, art and drafting supplies, gift items, and a wide selection of imprinted campus wear are available.

University Center

Shawnee State's University Center was dedicated in the spring of 1992 and is the hub of cocurricular activities at the University and a home away from home for our students. A variety of functions and services are provided at the center.

Staff at the **Welcome Center** in the main lobby offer a list of campus activities, guide guests and students to their destinations, sell snacks, provide a list of campus clubs and organizations, and in general, assist you with any problem you may encounter.

Dining facilities for the University are located in the University Center. Breakfast, lunch, and dinner are served, as well as a wide variety of a la carte items. A main dining area and a snack bar are provided for the convenience of diners. The cafeteria is open from 7:00 a.m. to 7:00 p.m., Monday through Thursday, 7:00 a.m. to 5:00 p.m. on Friday, and 11:00 a.m. to 5:00 p.m. on Saturday. Hours of operation on Sunday vary, depending upon demand. A banquet room/study room, located on the second floor, is used for workshops, conferences, meetings, and any activity where food is served.

Two **student lounges** are provided for your use, relaxing or studying. The Micklethwaite Lounge, on the first floor, is warmed by a copper-clad fireplace. The second floor lounge has a disklavier player piano and two TV rooms and is located near the Micklethwaite Banquet Hall and three conference rooms.

A **game room** on the first floor has table tennis and pool tables, board games, cards, a 70" screen TV, video games, free film rentals, and athletic equipment which can be checked out by currently enrolled students.

Located on the first floor of the University Center behind the cafeteria, the **Internet Cafe** connects users to the rest of the world via the World Wide Web, the Internet, and email. Students, staff, and visitors can grab a cup of coffee or a sandwich and "surf the net" in this comfortable coffeehouse environment.

Offices for Student Activities, Housing and Residence Life, Student Senate, Student Programming Board, and other clubs and organizations are located on the first floor. The Offices of the Vice President for Student Affairs, the Registrar, Admission, Financial Aid, Transfer Placement, and the Bursar are located on the second floor.

The building also has an **ATM machine**, a **copier**, and a **postage stamp machine** for the convenience of our students and staff.

The University Center's hours of operation vary and are posted on the front door.

Housing and Residence Life

University Housing Policy

Shawnee State University is committed to the particular educational value that is provided by a residential campus community. The residential setting offers you an unparalleled opportunity to gain from the social interactions and other life experiences that characterize on-campus housing and dining.

As a condition of admission and continued enrollment, students not living within a 50-mile radius of the University with their immediate families are required to live in University Housing, to the extent that space is available, and to take their meals in dining facilities as provided in meal plans approved by the University. Exceptions to this policy include married students, single parents, veterans, juniors and seniors, and students over the age of 23.

If you feel that you should be exempt from this requirement, you must submit a Housing Requirement Exemption Form to the Office of Housing and Residence Life. Exemptions may be granted to students who:

- Live and travel to class from the principal residence of their parent(s) or legal guardian(s) which is on the border line of the 50-mile radius or live (at no cost to the student) within the 50-mile radius with a close relative. (In some cases, a notarized letter from the relative may be required along with the exemption form.)
- Can demonstrate other acceptable extenuating circumstances.

For exemption forms or more information on exemptions, contact the Office of Housing and Residence Life. Nonexempt freshmen and sophomores not residing on campus are considered in violation of this policy and may have their records placed on hold with the University, thus preventing future registration.

Living on Campus

The residence life experience is one you will remember for a lifetime, with lasting friendships, opportunities for involvement, and the chance to learn about living with others. Whether you are required to live on campus, or are simply looking at on-campus housing as an option, you will find that our convenience, service, security, and comfort make University Housing a great place to live!

Our apartments offer students an independent living style with residence life staff there to assure maximum safety and service. Located on the east end of campus, all of our apartment complexes are within minutes of any university building. Each apartment is furnished, and you will find many luxuries you wouldn't expect in on-campus housing.

Throughout the year, the Housing and Residence Life staff offer many events for resident involvement. From volleyball tournaments and block parties to seminars on memory techniques and stress relief, we try to provide opportunities for students to socialize and take a look at the issues that face them.

On-Campus Dining

The Bears' Den Cafe offers Shawnee State students the opportunity to have fresh, nutritionally sound meals in a community atmosphere. Our dining service features an appetizing menu that changes from day to day, a salad bar, and the ever-popular grill items, such as hamburgers, pizza, and fries, which are available every day.

Housing and Residence Life Information

Applications and contracts are issued for a three-quarter academic year or the remainder of the academic year in which the student applies. A refundable \$200.00 security deposit is required to hold a space for an incoming student.

For further information, contact the Office of Housing and Residence Life at:

Shawnee State University
940 Second Street
Portsmouth, Ohio 45662-4344
(614) 355-2628

or the Office of Student Activities in the University Center, (614) 355-2217.

The Alumni Association

The Shawnee State Alumni Association encourages a relationship between the University and its alumni so that higher education in the southern Ohio region and beyond may benefit. With more than 8,000 members, the Association fosters a sense of continuity between collegiate and employment experiences. Served by twelve committees, members of the Association benefit from a variety of programs, such as networking and professional development.

In addition, the Association is committed to helping the alumni of tomorrow—today's Shawnee State student. Through Adopt-A-Freshman and Adopt-A-Grad, alumni serve as mentors for educational, social, career, and personal growth. The Association's activities, from recruitment to athletics and from retention to philanthropy, promote the spirit of higher education.

For more information about the Alumni Association and its programs, please call (614) 355-ALUM.

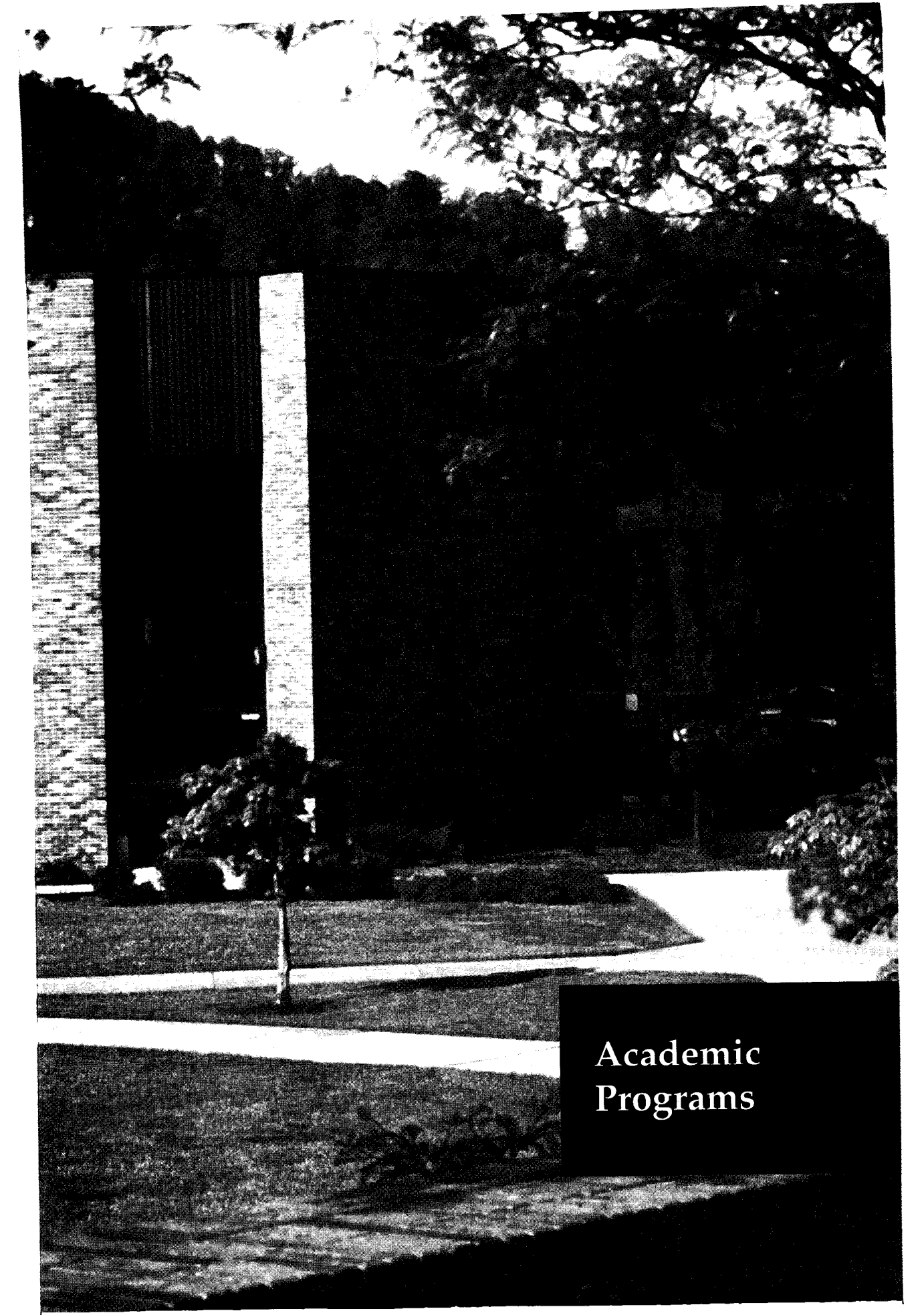

Academic
Programs

Programs of Study

Bachelor of Arts

English/Humanities, General
 English/Humanities, Elementary Education
 History
 International Relations
 Social Sciences
 Social Sciences, Elementary Education
 Social Sciences, Legal Assisting (2+2)

Bachelor of Fine Arts

Ceramics, Drawing, Painting
 Ceramics, Drawing, Painting with Visual
 Arts (K-12) Education Certification
 Studio Arts
 Studio Arts with Visual Arts (K-12)
 Education Certification

Bachelor of Science

Biology
 Biology, Environmental Science
 Biology, Pre-Medicine
 Business Administration
 Business Administration, Health
 Management
 Business Administration, Legal Assisting
 (2+2)
 Business Administration, Management
 Information Systems
 Business Administration, Management
 Information Systems (2+2)
 Chemistry
 Chemistry, Environmental Science
 Chemistry, Pre-Medicine
 Computer Engineering Technology
 Environmental Engineering Technology
 Mathematical Sciences
 Mathematical Sciences, Secondary Education
 Medical Laboratory Science
 Natural Science, Mathematics
 Natural Science, Mathematics, Elementary
 Education
 Natural Science, Mathematics, Secondary
 Education
 Natural Science, Biology
 Natural Science, Biology, Elementary
 Education
 Natural Science, Biology, Environmental
 Science
 Natural Science, Chemistry
 Natural Science, Chemistry, Elementary
 Education
 Natural Science, Chemistry, Environmental
 Science

Bachelor of Science (cont'd.)

Occupational Therapy
 Plastics Engineering Technology
 Sports Studies, Athletic Training
 Sports Studies, Sports Management

Associate of Applied Business

Accounting, Professional
 Accounting, Management
 Business Information Systems
 Business Management, General
 Business Management, Focused
 Legal Assisting
 Office Administration Technology

Associate of Applied Science

Associate Degree Nursing
 Computer Aided Drafting and Design
 Dental Hygiene
 Electromechanical Engineering Technology
 Emergency Medical Technology
 Instrumentation and Control Engineering
 Technology
 Medical Laboratory Technology
 Occupational Therapy Assistant
 Physical Therapist Assistant
 Plastics Engineering Technology
 Radiologic (X-ray) Technology
 Respiratory Therapy

Associate of Arts

Arts/Humanities, General
 Arts/Humanities, Art
 Arts/Humanities, Communications
 Arts/Humanities, English
 Arts/Humanities, Music
 Social Science

Associate of Science

Mathematics
 Sciences

Associate of Individualized Studies

See pages 62 and 103 of the current catalog for description.

Certificate

Computer Aided Drafting and Design
 (CADD)
 Computer Technology
 Emergency Medical Technology (EMT)
 Environmental Science
 Plastics Engineering Technology

Other degrees and programs are in various stages of development and may be available before the next catalog is published. If you'd like more information, please call:

College of Arts and Sciences • (614) 355-2554
 College of Professional Studies • (614) 355-2270
 Office of Admission • 1 (800) 959-2SSU

General Education Program

All students studying toward a baccalaureate degree at Shawnee State are required to complete the University's General Education Program (GEP). This group of courses gives you the opportunity to acquire the characteristics of an educated person—something quite distinct from the goals of other courses associated with the degree programs offered by Shawnee State. Most courses required for a specific degree program are meant to give you the ability to practice a profession and further your professional education. The goal of Shawnee State University, however, goes beyond professional education to preparing you to function effectively in the multiple roles demanded by contemporary life. In this respect, the General Education Program, supports the University's mission statement.

The GEP is a combination of required and elective courses, grouped in categories, each chosen for the contribution it makes to the skills or knowledge characteristic of university graduates.

Our Commitment to Your Success

Shawnee State's General Education Program is committed to:

- Providing you with an undergraduate education that includes competence in written communication, oral communication, scientific and quantitative reasoning, critical analysis, and logical thinking.
- Providing you with a breadth of knowledge that goes beyond education for a specific discipline or profession.
- Providing you with a breadth of experience that includes knowledge and understanding of multicultural factors.
- Ensuring that you have the ability to reflect carefully upon ethical issues and can enter into reasoned dialogue about these issues.

- Preparing you to become an independent and continuing learner.

As part of our commitment to your success, Shawnee State University has adopted the goal of integrating technological literacy, information literacy, and computer literacy into the courses included in the General Education Program.

General Education Program Requirements by Content Category

A more complete description of each category follows. Specific course descriptions are found in their own section of this catalog, beginning on page 154.

English Composition	12 Hours
Fine and Performing Arts	4 Hours
Quantitative Reasoning	4 Hours
Social Sciences	4 Hours
Natural Science	8 Hours
Ethics	4 Hours
Cultural Perspectives	8 Hours
Capstone	4 Hours
Total Hours Required	48 Hours

It should be noted that in cases where a single course meets both the General Education Program and requirements of the major, the total number of hours required for the GEP will be reduced by the number of related course hours. The minimum credit hours required for the baccalaureate degree shall not, however, be less than 186.

English Composition (12 Hours)

These courses provide an opportunity for you to develop as a writer. Their goal is for you to learn to write clearly, concisely, and creatively in a variety of formats.

☛ You are required to take *all three* of the following courses in English composition:

- ENGL 111S Discourse and Composition (4)
- ENGL 112S Composition and Research (4)
- ENGL 115S Composition and Literature (4)

Fine and Performing Arts (4 Hours)

You should leave the GEP with a greater appreciation of how the arts contribute to an enriched quality of life. Courses in this category include either an art history, art appreciation, music, or theatre component.

☛ You are required to *choose one course* from the following list:

- ARTH 101 Introduction to Art (4)
- ENGL 275 American Film History (4)
- MUSI 120 Intro. to Music Literature (4)
- MUSI 220 Music Literature (4)
- PHIL 300 Philosophy of Film (4)
- THAR 100 Introduction to Theatre (4)

Quantitative Reasoning (4 Hours)

This component of the General Education Program addresses the nature of mathematical thought and its impact on modern life. To fulfill the quantitative reasoning component of the GEP, each course contains active communication about mathematics (which includes reading and/or writing and/or speaking), exercises designed to stimulate critical thinking, the use of mathematical-related technology, and an emphasis on problem solving. In addition, each course stresses data and data analysis, demonstrates the application of mathematics to a variety of disciplines, and incorporates activity based learning.

☛ You are required to *choose one course* from the following list:

- MATH 110S Mathematics Core Course (4)
- MATH 131 College Algebra (4)
- MATH 150 Principles of Statistics (4)
- MATH 170 Applied Finite Mathematics (4)
- MATH 190 Brief Calculus with Applications (4)
- MATH 201 Calculus 1 (4)
- MATH 220 Discrete Mathematics (4)
- MATH 250 Statistics 1 (4)

Social Sciences (4 Hours)

This GEP component introduces you to the breadth and depth of the influence the social sciences have on contemporary life. Courses reflect an interdisciplinary or cross disciplinary approach with the expectation of increasing your awareness of the interconnectedness of the social sciences.

☛ You are required to *choose one course* from the following list:

- ANTH 250 Principles of Cultural Anthropology (4)
- ANTH 371 Islamic Religion, Culture, & Civil. (4)
- GEOG 130 Economic Geography (4)
- GOVT 350 National Policy Issues (4)
- GOVT 401 State of the World (4)
- HIST 371 Islamic Religion, Culture, & Civil. (4)
- HIST 410 Intellectual History 1 (4)
- HIST 411 Intellectual History 2 (4)
- SOCI 110S Found. of Social Science (4)
- SOCI 101 Introduction to Sociology (4)
- SOCI 312 Sociology of Religion (4)
- SOCI 410 Social Stratification (4)

Natural Science (8 Hours)

The natural science component of the General Education Program addresses scientific reasoning.

☛ You may *choose one of the following two options*:

- OPTION 1 NTSC 110S Natural Science (4) AND one additional natural science course (BIOL, CHEM, GEOL, NTSC, PHYS, PSCI) above 110 with a lab component.
- OPTION 2 A minimum of 12 hours in natural science courses (BIOL, CHEM, GEOL, NTSC, PHYS, PSCI) above 110, which includes at least 4 hours of a laboratory component.

Ethics (4 Hours)

Ethics stresses reasoning about conclusions rather than views one might hold. Therefore, ethics courses examine a number of concepts and principles, and sometimes professional canons and codes of conduct, with a view to understanding more of what each means, becoming more aware of alternatives and critically assessing the foundations possible for these standpoints. This process is open-ended. An essential focus of this approach to moral reasoning is the development of your capacity to actively participate in dialogue with other moral views.

In an ethics course, you are evaluated first and foremost on how well you reason about moral issues. You are neither evaluated on the particular position you reach, nor whether it agrees with someone else's position, but on how well you reason about an issue. In reasoning toward a conclusion, you are required to address possible counter arguments to your position. You are also expected to demonstrate an understanding of other selected positions, especially the reasoning behind these positions.

☛ *Choose one course* from the following list:

- BUMG 331 Business Ethics (4)
- PHIL 320S Ethics in Pub. and Priv. Life (4)
- PHIL 331 Business Ethics (4)
- PHIL 332 Biomedical Ethics (4)
- PHIL 334 Environmental Ethics (4)
- ROCI 485S Reflect. on Comm. Involvement (4)

Cultural Perspectives (8 Hours)

16 hours if Option 2 is selected

The goal of this GEP component is to help you understand aspects of western and non-western cultures and to appreciate the multicultural nature of modern society. Courses may vary as to discipline, content, and approach,

but each instills some comprehension of the complex historical, cultural, or sociological contexts which inform contemporary experience.

▣ **Western Perspective:** *Select one of the following courses.*

- ENGL 225S Civilization and Literature 1 (4)
- ENGL 226S Civilization and Literature 2 (4)
- HIST 225S Civilization and Literature 1 (4)
- HIST 226S Civilization and Literature 2 (4)

▣ **Non-Western Perspective:** *Choose one of the following two options.*

OPTION 1

Select one of the following courses pertaining to a non-Western perspective.

- ANTH 371 Islamic Religion, Culture, & Civil. (4)
- ARTH 366 Non-Western Survey (4)
- ENGL 227S Civilization and Literature 3 (4)
- HIST 227S Civilization and Literature 3 (4)
- HIST 260 East Asian History (4)
- HIST 330 History of Southern Africa (4)
- HIST 371 Islamic Religion, Culture, & Civil. (4)
- HIST 420 Middle East in Modern Times (4)
- GEOG 201 Cultural Geography (4)
- GEOG 351 Regional Geog. of the Middle East (4)
- GOVT 320 Third World Politics (4)
- GOVT 370 Global Politics (4)

OPTION 2

Complete a one-year sequence (12 sequenced credit hours) of foreign language.

Capstone (4 Hours)

▣ **Senior Seminar 490S** (cross-listed according to your major: BUBA, ENGL, ETCO, NTSC, or SOCI) comes late in your university experience and gives you the opportunity to write, speak, think, analyze, synthesize, and integrate. A central part of the seminar is the research and writing of a major paper and an oral presentation of your findings.



**College of
Arts and
Sciences**

College of Arts and Sciences

The overall mission of the College of Arts and Sciences is the liberal arts education and career preparation of Shawnee State students. Liberal arts education provides graduates with intellectual skills, substantive knowledge, and habits of the mind that promise rewarding careers and the more abundant life.

Courses provided by the College of Arts and Sciences contribute to your capability for abstract and systematic analysis and comprehension of the scientific method and encourage appreciation for and understanding of the varieties of artistic expression. These courses contribute to your flexibility, enabling you to see problems in a new light and to pursue alternative solutions. They also provide the communication and interpersonal skills essential for sharing these ideas in an increasingly collaborative and global workplace.

Liberal arts education at Shawnee State incorporates the teaching of these skills into a program that alerts you to the complexity of human history and diversity of cultures while exploring alternative approaches to contemporary social, economic, and political issues. Acknowledging the moral dimension of many of these questions, the liberal arts program explores ethical approaches and encourages you to develop a personal philosophy of life.

The University's commitment to liberal education begins with the College of Arts and Sciences' General Education Program, which emphasizes the importance of knowledge, values, and cultural enrichment. Building on the General Education Program, the College provides a spectrum of liberal arts degree programs in the arts and humanities, mathematics, the natural sciences, the social sciences, and teacher education. These degree programs prepare you for a career or successful matriculation into a graduate or professional degree program.

For More Information

Jerry G. Holt, Ph.D., Dean
Linda D. Plummer, Secretary
College of Arts and Sciences
Shawnee State University
940 Second Street
Portsmouth, Ohio 45662-4344
Phone: (614) 355-2554
Fax: [614] 355-2596
E-mail: jholt@shawnee.edu
lplummer@shawnee.edu

Degrees Offered

Bachelor of Arts

English/Humanities, General
English/Humanities, Elementary Education
History
International Relations
Social Sciences
Social Sciences, Elementary Education
Social Sciences, Legal Assisting (2 + 2)

Bachelor of Science

Biology
Biology, Environmental Science
Biology, Pre-Medicine
Chemistry
Chemistry, Environmental Science
Chemistry, Pre-Medicine
Mathematical Sciences
Mathematical Sciences, Secondary Education
Natural Science, Mathematics
Natural Science, Mathematics, Elementary Education
Natural Science, Mathematics, Secondary Education
Natural Science, Biology
Natural Science, Biology, Elementary Education
Natural Science, Biology, Environmental Science
Natural Science, Chemistry
Natural Science, Chemistry, Elementary Education
Natural Science, Chemistry, Environmental Science

Bachelor of Fine Arts

Ceramics, Drawing, Painting
Ceramics, Drawing, Painting with Visual Arts (K-12) Education Certification
Studio Arts

Bachelor of Fine Arts (cont'd.)

Studio Arts with Visual Arts (K-12)
Education Certification

Associate of Arts

Arts/Humanities, Arts
Arts/Humanities, Communications
Arts/Humanities, English
Arts/Humanities, General
Arts/Humanities, Music
Social Science

Associate of Science

Mathematics
Sciences

Associate of Individualized Studies

See page 62 of the current catalog for description.

Faculty: A Commitment to Teaching, Scholarship/Research and Creative Activities, and Service

The College of Arts and Sciences' faculty are dedicated and talented individuals. Their graduate degrees are from the finest universities in the world, and they care deeply about your personal growth and academic success. The outstanding talent and achievements of our alumni are due, in large part, to the high quality of teaching of the faculty.

Quality teaching is the primary emphasis of the College, and its faculty are dedicated to extending the frontiers of knowledge. To enrich their teaching, faculty are contributing to the body of significant research and scholarly work and creative activities in their disciplines as well as providing service to the community, region, state, and nation.

Accelerated Bachelor's Degree Programs

Baccalaureate degrees offered by the College of Arts and Sciences are planned in such a way that you can complete all requirements by taking classes during a twelve-quarter period, spread over four academic years. However, the requirements of some baccalaureate degrees

make it possible for you to earn your degree in a shorter period of time.

To earn a degree in three years, you need to take classes in the summer and/or take 18 or more hours each quarter, with the permission of your department chairperson or dean and the registrar. Careful planning of your course schedule is necessary. If you are interested in pursuing a three-year degree program, you should talk to your faculty advisor to make sure that this option is possible.

For more information about an accelerated bachelor's degree, contact the appropriate department chairperson or the dean.

Selecting and Declaring a Degree Major

You should consider a choice of major and career early in your degree program, if not before. You are encouraged to seek the advice of College of Arts and Sciences faculty and, also, staff in the Office of Counseling and Career Services. Your own interests, aptitudes, and professional/career goals should play a central role in selecting a degree major.

Double Major Guidelines

The completion of at least one major is required for a baccalaureate degree. The completion of a second major is an option which any College of Arts and Sciences student may elect. If you wish to pursue more than one major, you must consult with the appropriate department chairperson(s) or dean.

- The two majors must be in different subject matters.
- Each major must meet all the requirements set by the College of Arts and Sciences and the department offering the major.
- Each major must contain at least 45 hours not found in the other major.

Academic Advising

The College of Arts and Sciences is committed to quality academic advising, because it is essential to the ultimate success of our students. Once you have selected a major, you are advised by the teaching faculty of your department.

Please consult your academic advisor regarding the two-year schedule for the department in order to determine when the department plans to offer specific courses. The chairperson of your department will assign you an academic faculty advisor, ensuring that the department's academic advising system meets your individual needs and requirements as well as those of the department, the College, and the University. The dean of the College of Arts and Sciences facilitates answers to interdepartmental questions and exceptions and changes to related academic requirements.

Baccalaureate Degree Requirements

The College of Arts and Sciences awards its baccalaureate degrees to students who meet the following minimum requirements. Please see individual degree programs for any additional requirements.

- A minimum of 186 credit hours, including 48 credit hours in the General Education Program.
- A minimum 2.00 cumulative grade point average for all courses taken at Shawnee State University.
- Completion of at least 90 credit hours at the 200 level or above.
- Completion of at least 45 credit hours at Shawnee State University, of which 35 credit hours must be the upper division courses (300-400 level courses).
- A minimum of 60 credit hours in the major field of study.
- Petition for graduation in accordance with the rules prescribed by the University.

Minors

A minor is a field of study, within the baccalaureate degree, that may be taken to widen your area of interest or increase your career opportunities. Contact specific departments for information regarding minor offerings and minor field of study course requirements. Taking a minor is optional and not required.

Associate of Arts and Associate of Science Degrees

The College of Arts and Sciences offers several programs of study which lead to two-year associate degrees. The associate degree programs allow you to enter the job market immediately after you graduate or to transfer into certain baccalaureate degree programs.

In order to ease the transfer process, the following associate of arts and associate of science degree requirements will be modified to include a revised transfer module. Therefore, if you wish to pursue either degree, you are advised to work closely with an advisor during this transition period.

Associate of Arts Degree Curriculum

I. General Education Requirements

- A. Composition — 12 hours minimum
ENGL 111S Discourse and Composition (4); ENGL 112S Composition and Research (4); ENGL 115S Composition and Literature (4)
Students may take additional courses from the following (optional): ENGL 232 (3); ENGL 240 (3); ENGL 245 (3)
- B. Mathematics — 4 hours minimum
MATH 110S Mathematics Core Course (4)
Students may choose additional mathematics courses from the following (optional): MATH 131 (4); MATH 132 (4); MATH 201 (4); MATH 202 (4); MATH 250 (4)
- C. Arts and Humanities — 16 hours minimum
ENGL/HIST 225S Civilization and Literature (4)
and two courses from the following: ARTH 261 (4); ARTH 262 (4); ENGL 200 (4); MUSI 220 (3); PHIL 100 (4)
and one course from the following: ENGL 203 (4); ENGL 210 (4); ENGL 211 (4); ENGL 212 (4); MUSI 221 (3); MUSI 222 (3); MUSI 223 (3); PHIL 103 (4); PHIL 105 (4)
- D. Social Science — 16 hours minimum
SOC 110S Foundations of Social Science (4)
HIST/ENGL 226S Civilization and Literature 2 (4)
and one course from the following: ECON 101 (4); GEOG 125 (4); GOVT 101 (4); HIST 111 (4); HIST 112 (4); HIST 113 (4); PSYC 101 (4); SOCI 101 (4)
and one course from the following: ANTH 101 (4); ANTH 250 (4); ECON 102 (4); GOVT 240 (4); GOVT 250 (4); HIST 201 (4); HIST 202 (4); HIST 203 (4); PSYC 151 (4); PSYC 273 (4); SOCI 201 (4); SOCI 205 (4)
- E. Natural Sciences — 12 hours minimum
NTSC 110S Natural Science (4)
and 8 additional hours from the following: BIOL

151 (5) (4 lec./2 lab); CHEM 121 (4), CHEM 122 (4); CHEM 141 (4); CHEM 142 (4); CHEM 143 (4) (all CHEM - 3 lec./3 lab); GEOL 111 (4) (3 lec./2 lab); PHYS 201 (4); PHYS 202 (4); PHYS 203 (4) (all PHYS - 3 lec./3 lab)

Students may choose additional courses from the following (optional): BIOL 162 (5); BIOL 202 (5); BIOL 203 (5); CHEM 200 (4); GEOL 112 (4); PHYS 210 (4)

Note: Students cannot receive credit for both CHEM 121/122 and CHEM 141/142 series.

II. Concentration Area — 30 hours

A. Arts

Selected courses in an area of specialization chosen from the following list of humanities subject areas to complete the associate of arts degree.

Art	Humanities	Music
Comparative Arts	Journalism	Philosophy
English	Language	Theatre

NOTE: Beginning with the summer of 1996, the Department of Arts and Humanities requires

students majoring in arts/humanities to keep an Assessment Portfolio of significant writings. This Portfolio is reviewed by the Department to help determine student progress and curriculum needs. Associate of arts students are required to have at least eight significant papers in their Assessment Portfolios, which must be submitted to the Department when they petition for graduation. Failure to submit the Portfolio requires that students participate in a series of comprehensive writing activities that could delay graduation.

B. Social Sciences

Selected courses in an area of specialization chosen from the following list of subject areas to complete the associate of arts degree:

Anthropology	Government	Psychology
Economics	History	Sociology
Geography		

Associate of Science Degree Curriculum

I. General Education Requirements

A. Communications — 12 hours minimum

ENGL 111S Discourse and Composition (4); ENGL 112S Composition and Research (4); ENGL 115S Composition and Literature (4)

B. Mathematics — 8 hours minimum

MATH 110S Mathematics Core Course (4)

and one additional course from the following: MATH 131 (4); MATH 132 (4); MATH 201 (4); MATH 202 (4); MATH 250 (4)

C. Arts and Humanities — 12 hours minimum

ENGL/HIST 225S Civilization and Literature (4)

and two of the following: ARTH 261 (4); ARTH 262 (4); ENGL 200 (4); MUSI 220 (3); PHIL 100 (4)

Students may take additional courses from the following (optional): ENGL 203 (4); ENGL 210 (4); ENGL 211 (4); ENGL 212 (4); MUSI 221 (3); MUSI 222 (3); MUSI 223 (3); PHIL 103 (4); PHIL 105 (4)

D. Social Sciences — 12 hours minimum

SOCI 110S Foundations of Social Science (4)
ENGL/HIST 226S Civilization and Literature 2 (4)

and one of the following: ECON 101 (4); GEOG 125 (4); GOVT 101 (4); HIST 111 (4); HIST 112 (4); HIST 113 (4); PSYC 101 (4); SOCI 101 (4)

E. Natural Sciences — 16 hours minimum

NTSC 110S Natural Science (4)

and 12 additional hours chosen from the

following: BIOL 151 (5) (4 lec./2 lab); CHEM 121 (4), CHEM 122 (4); CHEM 141 (4); CHEM 142 (4); CHEM 143 (4) (all CHEM - 3 lec./3 lab); GEOL 101 (4) (3 lec./2 lab); PHYS 201 (4); PHYS 202 (4); PHYS 203 (4) (all PHYS - 3 lec./3 lab)

Students may take additional courses from the following (optional): BIOL 162 (5); BIOL 202 (5); BIOL 203 (5); CHEM 200 (4); GEOL 112 (4); PHYS 210 (4)

Note: Students cannot receive credit for both CHEM 121/122 and CHEM 141/142 series.

II. Concentration Area — 30 hours

A. Science

Selected courses in an area of specialization chosen from one of the following subject areas:

Biology
Physical Science (includes chemistry, geology, physics, and physical science)

B. Mathematical Sciences

1. Selected courses from mathematics — 22 hours minimum must be numbered above 110.
2. Science — 8 hours minimum must be chosen from biology, chemistry, geology, or physics numbered above 100.

Associate of Individualized Studies Degree

The associate of individualized studies degree (AIS) at Shawnee State University allows you to formulate your own individualized program of study based upon specific criteria. The goal of this degree is to permit the student, under the guidance of faculty advisors, to combine selected courses in academic and/or technical areas that may not meet the degree requirements for Shawnee State's associate of arts, associate of science, associate of applied science, or associate of applied business degrees.

The following conditions must be met for completion of the degree: 1) a total of 90 credit hours of 100-level or above coursework with a minimum grade point average of 2.00; 2) a minimum of two areas of concentration with at least 20 credit hours in each; 3) a set of general

education requirements based upon specific criteria; and 4) completion of a set of required hours of credit after admission to the program.

For specific details and application forms for the program, contact the dean's office in the College of Arts and Sciences or the dean's office in the College of Professional Studies.

Preparation for Elementary or Secondary Education Certification

Elementary certification (grades 1-8) and secondary certification (grades 7-12) in mathematical sciences, natural sciences with mathematics concentration, and visual arts (K-12) are currently offered.

Secondary certification programs in English, natural science, and social science have now advanced beyond the department level and await final approval. For more information on the progress of these future offerings, please contact:

- Department of Arts and Humanities - (614) 355-2300
- Department of Natural Sciences - (614) 355-2301
- Department of Social Sciences - (614) 355-2234

If you wish to become certified in elementary or secondary education, you must first choose an appropriate major in the College of Arts and Sciences. In addition to completing the related B.A. or B.S. degree requirements, you must complete the professional education requirements and other eligibility criteria for elementary or secondary education certification. You are responsible for working with a Department of Teacher Education faculty advisor on certification matters.

Course Scheduling and Offerings

The College of Arts and Sciences is committed to scheduling daytime classes, introductory and upper level, in a way that allows you to complete a degree program in a four-year period of time. All General Education Program courses are also offered during the evening hours on a rotating basis, throughout the academic year.

As staffing permits, occasional upper division classes from the various arts and sciences disciplines are offered in the evenings. At this time, no arts and sciences degree program can be earned in the evenings over a five-year period. However, it may be possible to earn an associate of individualized studies degree in the evenings. Also, we are planning to offer a baccalaureate degree with a major in individualized studies that may be available through evening studies in the near future. You are encouraged to discuss specific course scheduling issues with your academic advisor or your department chairperson.

Pass/No-Credit Policy

Students in the College of Arts and Sciences are not permitted to take courses in their major on a pass/no-credit basis.

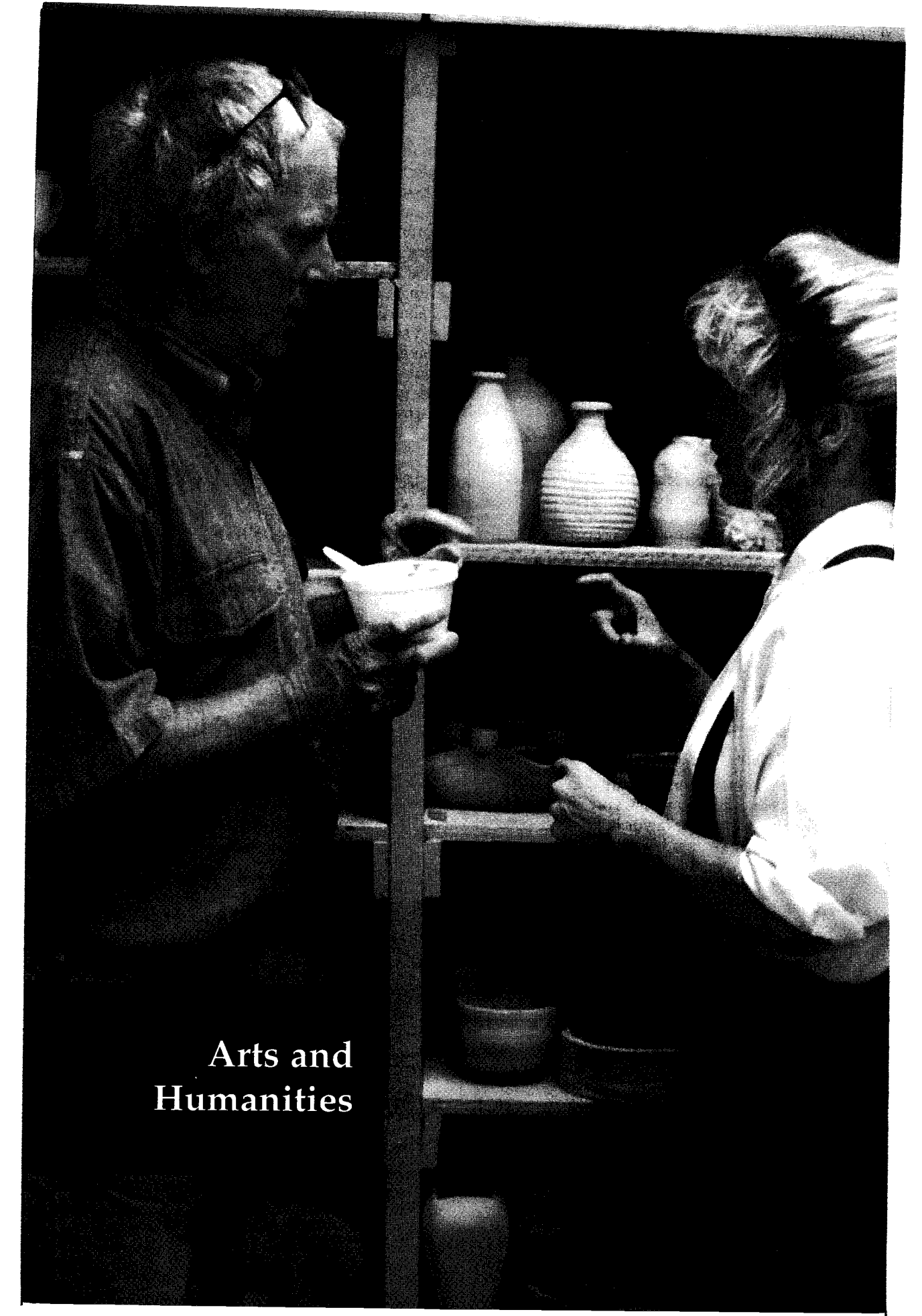

**Arts and
Humanities**

Arts and Humanities

The Department of Arts and Humanities develops students who can think and read critically, who write and speak clearly, and who understand the contributions literature, art, music, and philosophy can make to the quality of daily life. The Department believes that the skills of reading, writing, and thinking are the foundations upon which a successful college career is built. Therefore, all areas within the Department accept as part of their charge the development of writing and speaking skills. To this end, the Department is committed to providing opportunities for the integrated study of a variety of art forms as well as to infusing its academic programs with American, international, and multicultural perspectives.

For More Information

Elsie M. Shabazz, Secretary
 Department of Arts and Humanities
 Shawnee State University
 940 Second Street
 Portsmouth, Ohio 45662-4344
 Phone: (614) 355-2300
 Fax: [614] 355-2596
 E-mail: eshabazz@shawnee.edu

Degrees in Arts and Humanities

Bachelor of Arts

English/Humanities, General
 English/Humanities, Elementary Education Certification

Bachelor of Fine Arts

Ceramics, Drawing, Painting
 Ceramics, Drawing, Painting with Visual Arts (K-12) Education Certification
 Studio Arts
 Studio Arts with Visual Arts (K-12) Education Certification

Associate of Arts

Arts/Humanities, Art
 Arts/Humanities, Communications
 Arts/Humanities, English
 Arts/Humanities, General
 Arts/Humanities, Music

Associate of Individualized Studies

See page 62 of current catalog for description

Vern Riffe Center for the Arts

Shawnee State University's BFA programs are located in the \$17 million, 102,000 sq. ft., Vern Riffe Center for the Arts, which opened during the 1995-96 academic year. Art studios, comprising some 29 rooms with dramatic natural and artificial lighting, fill most of the east wing of the building. The first floor houses both the Levi Ceramics Suite and the photography suite. The 14 rooms in these two areas, as in the other studios throughout the Center, are equipped with state of the art equipment. The second floor houses the gallery, Richards Virtual Reality Multimedia Studio, art education, drawing, communications arts, and arts computer studios. The computer studio is a high level Macintosh-based studio for the use of students in all the arts. The multimedia studio has digital projection in many formats, surround sound, and one of only two infinite baffle speaker systems in the world. The third floor has studios for painting, life studies, fabric design/screen printing, lithography, and intaglio printmaking. The Center also houses a music wing, recital hall, black box theater, and an acoustically variable 1138 seat concert hall/theater.

Composition Labs

The English department maintains two computer composition classrooms in Massie Hall. These classrooms support the composition faculty's efforts to use word processing in the teaching of writing. Open labs are available at designated times.

The English Sequence

Students who must take the English sequence (English 111, 112, and 115) are required to take a placement exam. See explanations on page 27 about placement and the Special Note on page 191.

Bachelor Degrees

Bachelor of Arts with a Major in English/Humanities

The bachelor of arts degree with a major in English/Humanities requires 186 hours for students not seeking elementary certification and 196 hours for students seeking elementary certification.

Students seeking certification in elementary education may want to select English/Humanities as their major because a strong background in the language arts is essential for elementary school teachers. Other students may want to receive a degree without elementary certification. These students are required to complete 70 additional hours of electives. Careers in journalism, advertising, public relations, and many pre-professional programs, such as law, require excellent communication skills.

The Department strongly recommends that students who are not pursuing elementary certification focus on areas of specialization chosen from a variety of electives. For example, you may want to complete two or three years of foreign language or you may wish to concentrate in art, philosophy, additional English, social science, mathematics, natural science, or business. These areas of specialization should strengthen your chance for employment. In addition, the Department is in the process of developing some specific minors and concentrations which may be available before a new catalog is published. Check with your advisor as to the progress of these programs.

Important Notes

- Beginning with the summer of 1996, the Department of Arts and Humanities requires students majoring in arts/humanities to keep an Assessment Portfolio of significant writings. This Portfolio is reviewed by the Department to help determine student progress and curriculum needs. Bachelor of arts students are required to have at least 15 significant papers, including their Senior Seminar paper, in their Assessment Portfolio, which must be reviewed at the end of their sophomore year and submitted to the Department when they petition for graduation. Failure to submit the Assessment

Portfolio requires that students participate in a series of comprehensive writing activities that could delay graduation.

- Because of the need to avoid duplication of course requirements for elementary certification students and to plan an effective course of electives for those students not seeking elementary certification, the Department strongly recommends that English/humanities majors see an advisor each quarter.

Degree Requirements

General Education Program 48 Hours

Further information is listed on page 55 of the current catalog or can be obtained from the dean's office.

English/Humanities Courses 68 Hours

(Includes 20-hour elective block, of which 4 hours must be above the 300 level.)

Electives (Note: At least 24 hours of these electives must be from 300 and 400 level courses. The Department strongly recommends that you take specialized courses in one or two areas. Foreign language is an excellent area of specialization for English/humanities majors.) 70 Hours

Total Hours Required 186 Hours

English/Humanities Courses (68 Hours)

Area	Cr. Hrs.
Philosophy	4
Introduction to Literature (ENGL 200)	4
Linguistics (ENGL/LING 360, 362, 365, or 455 or ENGL 460)	8
Survey of Literature (ENGL 211, 212, 251, or 252)	8
Shakespeare (ENGL 301 or 302)	4
Theory and Practice in Composition (ENGL 315)	4
Literature Before 1800 (ENGL 311, 411, 421, and other suitable courses)	4
Literature After 1800 (ENGL 312, 321, 322, 441, 446, and other suitable courses)	4
American Literature (ENGL 273, 351, 371, 461, 471, and other suitable courses)	4
Literature as Social Perspective (ENGL 341, 342, 343, 344, 346, 349, 383, and other suitable courses)	4
Humanities Electives (Courses must be taken in at least two areas with four hours at the 300 level or higher)	20
Art History	
Music History	
Foreign Language	
Philosophy	
Linguistics (one additional course)	
Other suitable courses as added	

English/Humanities Major with Elementary Education Certification

Degree Requirements

General Education Program	48 Hours
<i>Further information is listed on page 55 of the current catalog or can be obtained from the dean's office.</i>	
English/Humanities Courses	56 Hours
Arts and Sciences Requirements	37 Hours
<i>See page 95 of current catalog.</i>	
Professional Education Require.	55 Hours
<i>See page 94 of current catalog.</i>	
Total Hours Required	196 Hours

English/Humanities Courses (56 Hours)

Area	Cr. Hrs.
Philosophy (PHIL 101 or 105 required of students beginning after June 1, 1997)	4
Introduction to Literature (ENGL 200)	4
Linguistics (ENGL/LING 360, 362, 365, or 455 or ENGL 460)	8
Survey of Literature (ENGL 211, 212, 251, or 252)	8
Shakespeare (ENGL 301 or 302)	4
Theory and Practice in Composition (ENGL 315)	4
Children's Literature (required for elementary education certification only)	4
Literature After 1800 (ENGL 312, 321, 322, 441, 446, and other suitable courses)	4
American Literature (ENGL 273, 351, 371, 461, 471, and other suitable courses)	4
Literature as Social Perspective (ENGL 341, 342, 343, 344, 346, 349, 383, and other suitable courses)	4
Humanities Electives (Courses must be taken in at least two areas with four hours at the 300 level or higher)	8
Art History	
Music History	
Foreign Language	
Philosophy	
Linguistics	
Other suitable courses	

Bachelor of Fine Arts Programs

The newest offerings in the Department of Arts and Humanities are the bachelor of fine arts degrees. The curriculum, which leads to the professional credential in the areas of ceramics, drawing, painting, or the generalist studio arts degree, offers the student a thorough grounding in the arts. Professional portfolios developed through participation in the BFA program may well lead the successful candidate to opportunities in graphic communications, design, computer art, photography, gallery and museum work, corporate curating, ceramic studio work, self-employed studio art, print-

making, or the opportunity to continue work elsewhere at the masters degree level (to acquire college teaching credentials).

Students may also choose to pursue a visual arts education certificate. This option prepares individuals to teach the visual arts in grades K-12.

The learning experience is enhanced by Shawnee State's \$17 million Vern Riffe Center for the Arts, a state-of-the-art facility which houses the BFA classes.

Special Note: Students in any arts and sciences bachelor's degree program must complete 60 credit hours at the 300 level or above. A minimum of 12 credit hours in the emphasis must be at the 300 level or above. A maximum of 9 credit hours of "special permission" topics classes may be counted toward the emphasis. An additional 4 credit hours of topics may count toward the studio elective.

Degree Requirements for the Bachelor of Fine Arts in Ceramics, Drawing, and Painting

General Education Program	48 Hours
<i>Further information is listed on page 55 of the current catalog or can be obtained from the dean's office.</i>	
Art Core Requirements	44 Hours
Art Specialization (Choose either ceramics, drawing, or painting.)	40 Hours
Art Studio Electives (Chosen from courses outside art specialization)	38 Hours
General Electives (Students planning an entrepreneurial career in the arts should consider taking BUAC 201, BUMG 225, BUMG 310, and BUMK 310.)	16 Hours
Total Hours Required	186 Hours

Degree Requirements for the Bachelor of Fine Arts in Studio Arts

General Education Program	48 Hours
<i>Further information is listed on page 55 of the current catalog or can be obtained from the dean's office.</i>	
Art Core Requirements	44 Hours
Studio Emphasis (Choose either ceramics, drawing, or painting.)	32 Hours
Art Studio Electives (Chosen from courses outside studio emphasis)	46 Hours
General Electives (Students planning an entrepreneurial career in the arts should consider taking BUAC 201, BUMG 225, BUMG 310, and BUMK 310.)	16 Hours
Total Hours Required	186 Hours

Art Core Requirements (44 Hours)

Course No.	Course	Cr. Hrs.
ARTH 261	Art History Survey 1	4
ARTH 262	Art History Survey 2	4
ARTH 263	Art History Survey 3	4
ARTH	Art History Electives (Choose from ARTH 101, 310, 331, 332, 360, 361, 364, or 366)	8
ARTS 101	Studio Foundations 1	4
ARTS 102	Studio Foundations 2	4
ARTS 103	Studio Foundations 3	4
ARTS 105	The Creative Process	4
ARTS 480	Senior Studio 1	4
ARTS 481	Senior Studio 2	4

Art Specialization (40 Hours)

Choose either a ceramics, drawing, or painting specialization.

CERAMICS

ARTS 231	Ceramics 1	4
ARTS 232	Ceramics 2	4
ARTS 233	Ceramics 3	4
ARTS 331	Intermediate Ceramics 1	4
ARTS 332	Intermediate Ceramics 2	4
ARTS 333	Intermediate Ceramics 3	4
ARTS 334	Raku Ceramics	4
ARTS 335	Porcelain Ceramics	4
ARTS 336	Glaze Theory & Practice	4
ARTS 338	Mold Making	4
ARTS 434	Advanced Raku	4
ARTS 435	Advanced Porcelain	4
ARTS 436	Adv. Glaze Theory & Practice	4

DRAWING

ARTS 271	Life Drawing 1	4
ARTS 272	Life Drawing 2	4
ARTS 273	Life Drawing 3	4
ARTS 275	Drawing 1	4
ARTS 276	Drawing 2	4
ARTS 371	Intermediate Life Drawing 1	4
ARTS 372	Intermediate Life Drawing 2	4
ARTS 373	Intermediate Life Drawing 3	4
ARTS 375	Intermediate Drawing 1	4
ARTS 376	Intermediate Drawing 2	4
ARTS 475	Advanced Drawing 1	4
ARTS 476	Advanced Drawing 2	4

PAINTING

ARTS 221	Painting 1	4
ARTS 222	Painting 2	4
ARTS 223	Painting 3	4
ARTS 321	Intermediate Painting 1	4
ARTS 322	Intermediate Painting 2	4
ARTS 323	Intermediate Painting 3	4
ARTS 324	Watercolor 1	4
ARTS 325	Watercolor 2	4
ARTS 326	Watercolor 3	4
ARTS 327	Figure Painting 1	4
ARTS 328	Figure Painting 2	4
ARTS 329	Figure Painting 3	4
ARTS 421	Advanced Painting 1	4
ARTS 422	Advanced Painting 2	4
ARTS 423	Advanced Painting 3	4

ARTS 424	Advanced Watercolor 1	4
ARTS 425	Advanced Watercolor 2	4
ARTS 426	Advanced Watercolor 3	4
ARTS 427	Adv. Figure Painting 1	4
ARTS 428	Adv. Figure Painting 2	4
ARTS 429	Adv. Figure Painting 3	4

Degree Requirements for Bachelor of Fine Arts with Visual Arts Education Certification (Grades K-12)

General Education Program 48 Hours
Further information is listed on page 55 of the current catalog or can be obtained from the dean's office.

Visual Arts Content	95 Hours
Professional Education Require.	61 Hours
Related Studies Requirement	11 Hours
Total Hours Required	215 Hours

Visual Arts Content (95 Hours)**DEGREE IN CERAMICS, DRAWING, OR PAINTING WITH K-12 EDUCATION CERTIFICATION**

Art Core Requirements	44 Hours
<i>See left-hand column, this page.</i>	
Art Specialization	40 Hours
<i>See left-hand column, this page.</i>	
Art Studio Electives	11 Hours
<i>Chosen from courses outside art specialization.</i>	

OR**DEGREE IN STUDIO ART WITH K-12 EDUCATION CERTIFICATION**

Art Core Requirements	44 Hours
<i>See left-hand column, this page.</i>	
Studio Emphasis	32 Hours
<i>Choose either ceramics, drawing, or painting. See left-hand column, this page.</i>	
Art Studio Electives	19 Hours
<i>Chosen from courses outside studio emphasis.</i>	

Professional Education Requirements (61 Hours)

Course No.	Course	Cr. Hrs.
EDUC 110	Teacher as Inquir. Professional 1	4
EDUC 210	Teacher as Inquir. Professional 2	4
EDUC 220	Soc./Phys./Intell. Growth & Dev.	3
EDUC 230	Instruct. Media, Tech., and Comp.	4
EDUC 240	Found. and Compet. Epistem. 1	3
EDUC 265	Teach. Individ. in a Pluralistic Soc.	4
EDUC 310	Teacher as Inquir. Professional 3	5
EDUC 330	Comm. Across the Curriculum	4
EDUC 340	Found. and Compet. Epistem. 2	3
EDUC 431	Studio Methods for Elem. Ed. <i>Cross-listed as ARTS 401</i>	6
EDUC 432	Studio Methods for Second. Ed. <i>Cross-listed as ARTS 402</i>	6
EDUC 450	Directed Teaching and Seminar <i>Cross-listed as ARTS 450</i>	15

Related Studies Requirement (11 Hours)

Course No.	Course	Cr. Hrs.
PSYC 312	Adolescent Psychology	4
PSYC 375	Educational Psychology	4
SPCH 103	Pub. Spk. and Hum. Comm.	3

New Degree Programs

Currently, the English Department is submitting a proposal for an English/Humanities major with secondary certification in language arts. Interested students should inquire about the progress of this program after July 1, 1997. Call (614) 355-2300.

In addition, minors are being proposed for theater, music, and philosophy. These minors will allow students to plan a more concentrated curriculum in areas of their special interests.

PRECALC
Functions and

ALGEBRA

Alg



Mathematical
Sciences

Mathematical Sciences

The Department of Mathematical Sciences provides Shawnee State's general education student with an appreciation of, and experiences with, the role of mathematics in our society. The Department also develops additional mathematical skills for those students whose academic programs require it and provides educational experiences for students who wish to specialize in mathematics.

In addition to close faculty-student working relations, the Department features an extensive tutoring program, use of technology in the curriculum, and modern student computing facilities.

Each of the Department's baccalaureate programs requires a senior research project which allows you to work closely with a team of faculty to study a mathematical topic in depth. The senior research project is designed to be an integrative and capstone experience and results in the development of a senior paper and presentation.

Each of the programs is described here in more detail. If you are interested in a degree in mathematics, you are encouraged to contact the Department at (614) 355-2301 for additional information. Mathematical sciences faculty look forward to showing you what Shawnee State has to offer.

For More Information

Thomas A. Carnevale, D.A., Chairperson
Carol Sexton, Secretary

Department of Mathematical Sciences
Shawnee State University
940 Second Street
Portsmouth, Ohio 45662-4344

Phone: (614) 355-2301

Fax: [614] 355-2596

E-mail: csexton@shawnee.edu

Degrees in Mathematical Sciences

Bachelor of Science

- Mathematical Sciences
- Mathematical Sciences with Secondary Education Certification
- Natural Sciences, Mathematics Concentration
- Natural Sciences, Mathematics Concentration with Elementary Education Certification
- Natural Sciences, Mathematics Concentration with Secondary Education Certification

Minor in the Mathematical Sciences

Associate of Science

- Mathematics Concentration

Associate of Individualized Studies

- See page 62 of the current catalog for description.

Bachelor Degrees

Bachelor of Science in Mathematical Sciences

This four-year program develops the analytical skills, knowledge base, and attitudes you need to use mathematics well and fosters your ability to learn mathematics and other technical material independently. Graduates of this program should be able to communicate technical concepts effectively and should have a solid understanding of the core subjects of undergraduate mathematics as well as some more specialized work at a more advanced level.

Possible career opportunities for students who successfully complete this program include actuarial science, statistics, operations research, computer science, law, business, and other fields where quantitative or analytic skills are of central importance. When combined with secondary education certification, graduates can also teach at the secondary level (grades 7-12).

The curriculum emphasizes the interdisciplinary nature of mathematics and its relationship to other disciplines as introduced by the required general education program. The learning experiences gained in the liberal arts and science courses are used as a foundation upon

which the mathematical sciences build and expand, showing that mathematics is not isolated but is part of an overall knowledge base. Students who major in the mathematical sciences are required, via the Connections Requirement, to take extra coursework in a discipline which makes extensive use of mathematics, such as engineering technology, economics, education, or business, thus furthering the University's goal of tying career oriented education to a liberal arts foundation.

Degree Requirements

General Education Program	48 Hours
<i>Further information is listed on page 55 of the current catalog or can be obtained from the dean's office.</i>	
Mathematical Sciences Core ¹	45 Hours
Computer Science Elective	4 Hours
Upper Division Sequence	8 Hours
Mathematical Science Elective (<i>Must be numbered 300 or higher.</i>)	4 Hours
Connections Requirement	12 Hours
General Electives	65 Hours
Total Hours Required	186 Hours

Mathematical Sciences Core (45 Hours)

All students completing a major in the mathematical sciences are required to take the following courses.

Course No.	Course	Cr. Hrs.
MATH 201	Calculus 1	4
MATH 202	Calculus 2	4
MATH 203	Calculus 3	4
MATH 204	Calculus 4	4
MATH 220	Discrete Mathematics	4
MATH 230	Linear Algebra	5
MATH 250	Statistics 1	4
MATH 301	Ordinary Differential Equations OR	4
MATH 430	Numerical Analysis	
MATH 360	Introduction to Probability	4
MATH 440	Mathematical Models OR	4
MATH 370	Operations Research 1	
MATH 496	Senior Research Project 1	1
MATH 497	Senior Research Project 2	3

Computer Science Elective (4 Hours)

All students completing a major in the mathematical sciences are required to complete one of the following:

BUIS 201	C Language	4
BUIS 206	Fortran 77	4
BUIS 207	Pascal Language	4

Upper Division Sequence (8 Hours)

All students completing a major in the mathematical sciences are required to complete one of the following sequences of upper division courses:

MATH 410	Modern Algebra 1 AND	4
MATH 411	Modern Algebra 2 OR	4
MATH 335	Intermediate Analysis AND	4
MATH 460	Real Analysis	4

Connections Requirement (12 Hours)

An important component of our program is assuring that all students gain exposure to how the mathematical sciences are used. Through the Connections Requirement, you complete courses in a particular area, such as education, economics, business, computer science, engineering technology, or advanced specialized topics in the mathematical sciences. You are strongly encouraged to complete all of the courses in at least one of the strands. Some of the strands were designed to be comparable to minors.

Business Strand

BUAC 201	Financial Accounting Principles
BUAC 203	Managerial Accounting
BUMG 235	Personnel Management
BULW 270	The Legal Environment of Business
BUFI 345	Managerial Finance
BUMG 310	Management Principles
BUMG 355	Quantitative Methods in Business
BUMG 385	Production/Operations Management
BUMK 310	Marketing Principles

Computer Science Strand

ETEC 102	Structured Programming
ETEC 103	Data Structures
ETEC 211	Assembly Language Programming 1
ETEC 212	Assembly Language Programming 2
ETEC 275	Systems Programming
ETEC 280	Programming Languages
ETEC 371	Operating Systems 1
ETEC 372	Operating Systems 2
ETEC 373	Advanced Operating Systems
ETEC 408	Algorithms and Problem Solving
ETEC 477	Concurrency

Economics Strand

ECON 101	Principles of Macroeconomics
ECON 102	Principles of Microeconomics
ECON 301	Intermediate Microeconomics
ECON 302	Intermediate Macroeconomics
ECON 310	Money and Banking (<i>cross-listed as BUFI 310</i>)
ECON 332	Managerial Econ. (<i>cross-listed as BUMG 332</i>)
ECON 425	Public Finance
ECON 480	Econometrics

¹ If MATH 201, 220, or 250 is used to satisfy the General Education Program, 41 hours are required in the Mathematical Sciences Core and 69 hours are required in General Electives.

Physics Strand

- PHYS 211 Calculus-Based Physics 1
- PHYS 212 Calculus-Based Physics 2
- PHYS 213 Calculus-Based Physics 3

Graduate School Preparatory Strand

- MATH 410 Modern Algebra 1 AND
 - MATH 411 Modern Algebra 2 OR
 - MATH 335 Intermediate Analysis AND
 - MATH 460 Real Analysis
- (whichever of the above sequences is not being used to satisfy the upper division sequence requirement)*
- MATH 450 Complex Variables
 - MATH 480 General Topology

Secondary Mathematics Education Strand

- MATH 300 History of Mathematics
- MATH 320 Foundations of Geometry
- MATH 405 Math. Enrich. for the Secondary Teacher
- MATH 470 Secondary Mathematics Methods

Industrial Management and Statistical Process Control Strand

- ETPL 400 Statistical Processes/Quality Control 1
- ETPL 405 Statistical Processes/Quality Control 2
- ETPL 410 Applied Statistical Experimentation
- MATH 370 Operations Research 1
- MATH 371 Operations Research 2
- BUMG 355 Quantitative Methods in Business
- BUMG 385 Production/Operations Management

Bachelor of Science in Natural Science, Mathematics

Shawnee State's bachelor of science in natural science degree program introduces you to a wide range of basic science disciplines and allows you to concentrate on one specific area. By selecting mathematics as the primary area of concentration, you may complete the requirements for the bachelor of science in natural science.

A number of career alternatives are available to students who complete this degree, including positions in government or industry that require quantitative competency, continued specialization in graduate school, and, when combined with elementary or secondary education certification, a career in elementary (grades 1-8) or secondary (grades 7-12) teaching.

Degree Requirements

General Education Program	48 Hours
<i>Further information is listed on page 55 of the current catalog or can be obtained from the dean's office.</i>	
Concentration Area 1¹ Mathematics	32 Hours
<i>courses numbered higher than MATH 130. In addition, coursework should include MATH 201, 202, and at least 12 hours at the 300-400 level</i>	
Concentration Area 2 Biology, chemistry, geology, or physics courses	16 Hours
<i>(select one area) numbered higher than 110</i>	
Concentration Area 3 Biology, chemistry, geology, or physics course	8 Hours
<i>(selected from area other than Concentration Area 2) numbered higher than 110</i>	
Senior Project in Mathematics	4 Hours
<i>(MATH 496 and 497)</i>	
Humanities/Social Science Electives	24 Hours
<i>From at least two areas</i>	
Mathematics Electives	8 Hours
<i>Numbered higher than MATH 1105</i>	
Computer Science Elective	4 Hours
<i>Select appropriate computer science course in consultation with department advisor.</i>	
General Electives	45 Hours
Total Hours Required	189 Hours

Note: A minimum of 35 hours must be at the 300 level or above.

Secondary Education Certification

You may prepare for a career teaching at the secondary level (grades 7-12) by choosing *either* the bachelor of science in mathematical sciences with secondary education certification *or* the bachelor of science in natural science with secondary education certification. The bachelor of science in natural science with secondary education certification may be especially appealing to you if your career plans include eventual certification in both mathematics and a science. Both degrees are described on the next page. *If you choose either of these options, you are urged to work closely with your mathematics and education advisors.*

¹ MATH 201 may not be used to satisfy both the General Education Program requirement and the Concentration Area 1 requirement.

Bachelor of Science, Mathematical Sciences with Secondary Education Degree Requirements

General Education Program	48 Hours
<i>Further information is listed on page 55 of the current catalog or can be obtained from the dean's office.</i>	
Mathematics Requirements	61 Hours
Professional Education Require.	57 Hours
Related Studies Requirements	32 Hours
Total Hours Required	198 Hours

Mathematics Requirements (61 Hours)

Course No.	Course	Cr. Hrs.
MATH 201	Calculus 1	4
MATH 202	Calculus 2	4
MATH 203	Calculus 3	4
MATH 204	Calculus 4	4
MATH 220	Discrete Mathematics	4
MATH 230	Linear Algebra	5
MATH 250	Statistics 1	4
MATH 300	History of Mathematics	4
MATH 320	Foundations of Geometry	4
MATH 360	Introduction to Probability	4
MATH 405	Math. Enrich. for Second. Teacher	4
MATH 410	Modern Algebra 1	4
MATH 411	Modern Algebra 2	4
MATH 440	Mathematical Models OR	4
MATH 301	Ordinary Differentials OR	
MATH 430	Numerical Analysis	
MATH 496	Senior Research Project 1	1
MATH 497	Senior Research Project 2	3

Professional Education Requirements (57 Hours)

EDUC 110	Teacher as Inquir. Professional 1	4
EDUC 210	Teacher as Inquir. Professional 2	4
EDUC 220	Soc./Phys./Intell. Growth and Dev.	3
EDUC 230	Instruct. Media, Tech., and Comp.	4
EDUC 240	Found. and Compet. Epistem. 1	3
EDUC 265	Teach. Individ. in a Pluralistic Soc.	4
EDUC 310	Teacher as Inquir. Professional 3	5
EDUC 330	Comm. Across the Curriculum	4
EDUC 340	Found. and Compet. Epistem. 2	3
EDUC 410	Gen. Methods for Secondary Ed.	4
EDUC 430/ MATH 470	Methods of Teaching Math. in Secondary Schools	4
EDUC 450	Directed Teaching and Seminar	15

Related Studies Requirements (28 Hours)

BUIS XXX	Computer Science Elective <i>(to be selected from BUIS 201, 206, or 207)</i>	4
PSYC 312	Adolescent Psychology	4
PSYC 375	Educational Psychology	4
SPCH 103	Public Speaking & Human Comm.	3
XXX	Electives <i>(to be selected from arts/humanities courses)</i>	13

Bachelor of Science, Natural Science with Secondary Education Certification Degree Requirements

General Education Program	48 Hours
<i>Further information is listed on page 55 of the current catalog or can be obtained from the dean's office.</i>	
Mathematics Requirements	61 Hours
Professional Education Require.	57 Hours
<i>See left-hand column, this page.</i>	
Related Studies Requirements	52 Hours
Total Hours Required	218 Hours

Mathematics Requirements (61 Hours)

MATH 201	Calculus 1	4
MATH 202	Calculus 2	4
MATH 203	Calculus 3	4
MATH 220	Discrete Mathematics	4
MATH 230	Linear Algebra	5
MATH 250	Statistics 1	4
MATH 300	History of Mathematics	4
MATH 320	Foundations of Geometry	4
MATH 360	Introduction to Probability	4
MATH 405	Math. Enrich. for Second. Teacher	4
MATH 410	Modern Algebra 1	4
MATH 440	Mathematical Models	4
MATH XXX	Mathematics Electives <i>(selected from MATH courses numbered above 300)</i>	8
MATH 496	Senior Research Project 1	1
MATH 497	Senior Research Project 2	3

Related Studies Requirements (52 Hours)

BUIS XXX	Computer Science Elective <i>(to be selected from BUIS 201, 206, or 207)</i>	4
PSYC 312	Adolescent Psychology	4
PSYC 375	Educational Psychology	4
SPCH 103	Public Speaking	3
XXX	Electives <i>(to be selected from arts/humanities courses)</i>	13

Students must also complete a second and third concentration in science as described below.

XXX	Natural Sciences Concentration Area 1 <i>(to be selected from one area— biology, chemistry, geology, or physics —and numbered higher than 110)</i>	16
XXX	Natural Sciences Concentration Area 2 <i>(to be selected from one science area not chosen for Concentration Area 1. Courses must be numbered higher than 110)</i>	8

Elementary Certification

(with bachelor of science in natural science and concentration in mathematics)

You may prepare for elementary education certification and specialize in the teaching of elementary (grades 1-8) mathematics by

choosing the certification option within the bachelor of science in natural science with the mathematics concentration. *If you choose this option, you are urged to work closely with your mathematics and education advisors.*

Degree Requirements

General Education Program ¹ <i>Further information is listed on page 55 of the current catalog or can be obtained from the dean's office.</i>	48 Hours
Concentration Area 1: <i>Mathematics courses numbered higher than MATH 130. MATH 201 and MATH 305 are required. In addition, at least 9 hours must be numbered 300 or above.</i>	32 Hours
Concentration Area 2 <i>Biology, chemistry, geology, or physics courses numbered higher than 110.</i>	16 Hours
Concentration Area 3 <i>To be selected from one science area not chosen for Concentration Area 2. Courses must be numbered higher than 110.</i>	8 Hours
Senior Project in Mathematics <i>(MATH 496 and 497)</i>	4 Hours
Computer Science Elective <i>(To be selected in consultation with department advisor.)</i>	4 Hours
Arts and Sciences Requirement <i>(Listed on page 95 of the current catalog or available from dean's office.)</i>	37 Hours
Professional Education Require. <i>(Listed on page 94 of the current catalog or available from dean's office.)</i>	55 Hours
Total Hours Required	204 Hours

Minor

Minor in the Mathematical Sciences

The mathematical sciences minor fosters analytical, critical, and quantitative thinking and empowers you to function effectively in a technological society. The minor also strengthens mathematical skills and improves your ability to solve problems in subject areas that use mathematics as a tool.

Requirements

A minor in the mathematical sciences consists of at least 29 credit hours in mathematics courses numbered 200 or above. Seventeen of these hours are required; you should consult with the chair of the Department of Mathematical Sciences regarding a study plan for the remaining hours.

Mathematical Sciences Minor Core (17 Hours)

The following courses are required of all students completing a minor in the mathematical sciences:

Course No.	Course	Cr. Hrs.
MATH 201	Calculus 1	4
MATH 202	Calculus 2	4
MATH 203	Calculus 3	4
MATH 230	Linear Algebra	5

Sample Course Sequence for Mathematical Sciences Minor

This is what a mathematics sequence might look like for a student whose major is in business.

Course No.	Course	Cr. Hrs.
MATH 201	Calculus 1	4
MATH 202	Calculus 2	4
MATH 203	Calculus 3	4
MATH 230	Linear Algebra	5
MATH 250	Statistics 1	4
MATH 350	Statistics 2	4
MATH 440	Mathematical Models	4

This is what a mathematics sequence might look like for a student whose major is in engineering technologies.

MATH 201	Calculus 1	4
MATH 202	Calculus 2	4
MATH 203	Calculus 3	4
MATH 220	Discrete Mathematics	4
MATH 230	Linear Algebra	5
MATH 301	Differential Equations	4
MATH 440	Mathematical Models	4

General Education Mathematics Requirements

In general, you may satisfy the mathematics component (Quantitative Reasoning - 4 hours, see page 56) of the General Education Program by completing one of the following courses:

¹ MATH 110S is the General Education Program requirement for the elementary education certification program.

Entry Points for Mathematics Courses

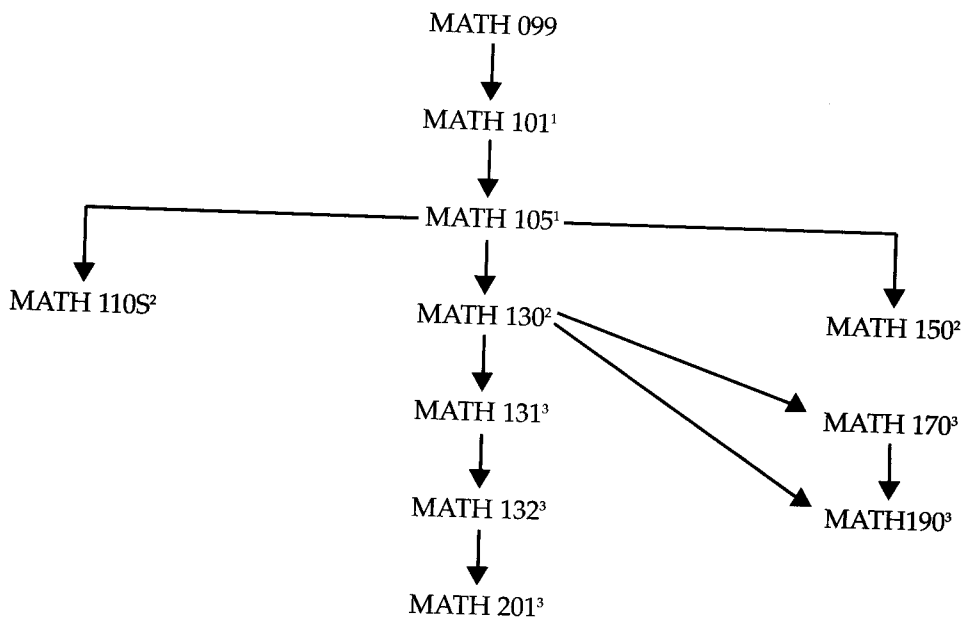

- MATH 110S Mathematics Core Course (4)
- MATH 131 College Algebra (4)
- MATH 150 Principles of Statistics (4)
- MATH 170 Applied Finite Mathematics (4)
- MATH 190 Brief Calculus with Applications (4)
- MATH 201 Calculus 1 (4)
- MATH 220 Discrete Mathematics (4)
- MATH 250 Statistics 1 (4)

However, some academic programs may require a specific MATH course to satisfy the General Education Program requirements. You should check with your faculty advisor before registering for a MATH course to see if it is one appropriate to your program and that you have fulfilled the course prerequisite.

Entrance into Mathematics Courses

If you are a degree-seeking student, you are required to take a mathematics placement test which, along with other factors, determines

the mathematics class in which you will be placed. Other factors include your background, program of interest, and ACT mathematics score. Many of the mathematics courses are sequential, so it is important for you to master the material in one course before moving on to the next.

You may be exempted from taking the mathematics placement test if you have received transfer credit for an appropriate mathematics course or if you have an ACT **Mathematics subject** score of 22 or higher.

The diagram above shows entry points for a number of mathematics courses or course sequences. Be sure to check with your faculty advisor before attempting to register for a mathematics course. Questions about placement or the appropriate course(s) should be directed to the Department of Mathematical Sciences (355-2301). Inquiries concerning taking placement tests should be directed to the Learning Center (355-2392).

¹ Students who need a rapid review of elementary algebra and basic geometry should consider enrolling in MATH 106.

² Students with an ACT Mathematics subject score of 22 or higher may register in these courses without taking the basic Shawnee State University mathematics placement test.

³ Entry into MATH 131, 132, 170, 190, or 201 is possible with satisfactory performance on the Shawnee State University advanced mathematics placement test. Contact the Department of Mathematical Sciences or the Learning Center.

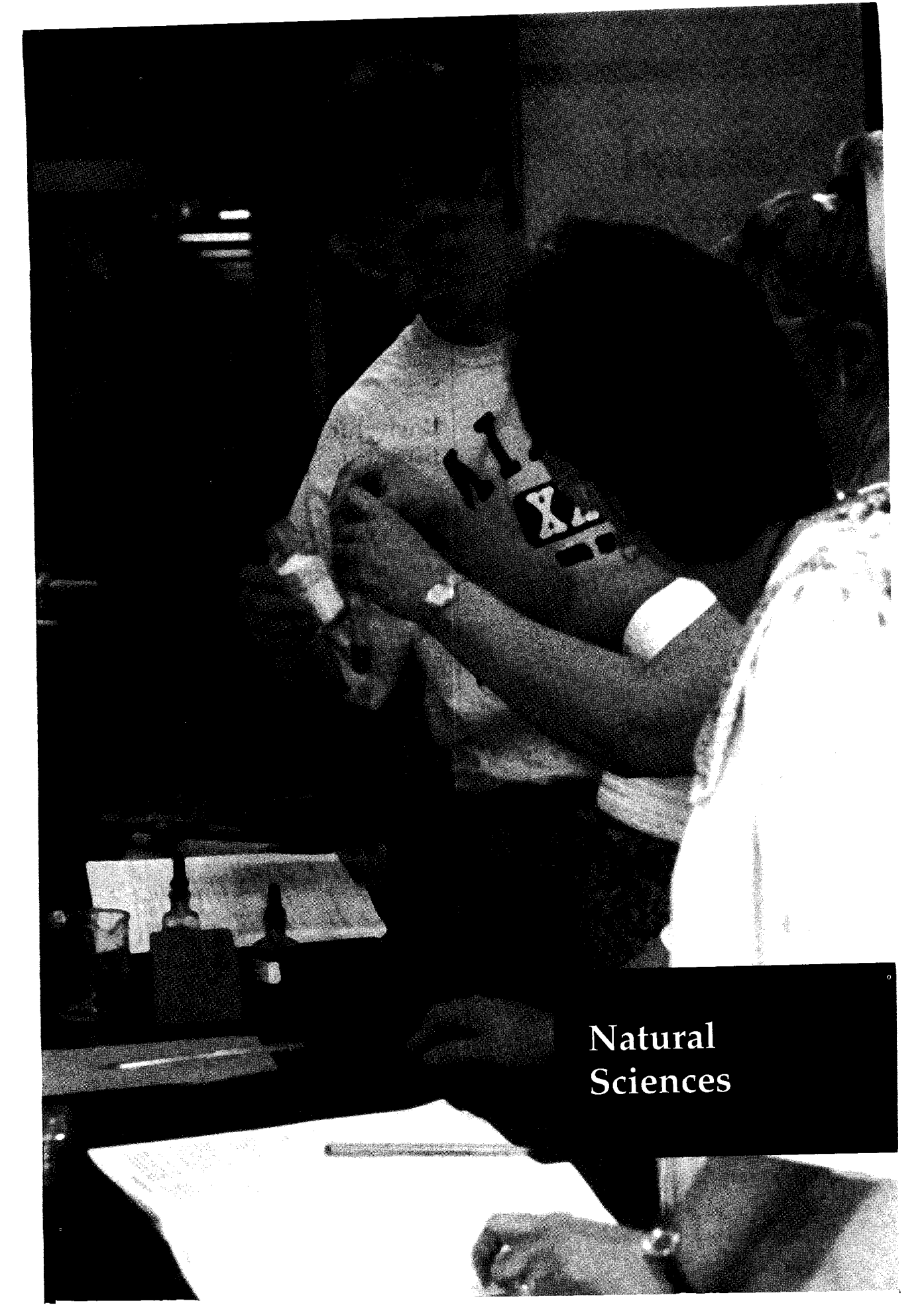

Natural
Sciences

Natural Sciences

The Department of Natural Sciences prepares students to succeed in an increasingly complex and technological world. Our baccalaureate programs in biology, chemistry, and natural science are designed to provide a solid foundation in general science and mathematics. In addition, each program provides students with the opportunity to build depth of knowledge and experience in a specific science discipline.

For More Information

Julia L. Basham, M.S., Chairperson
Carol Sexton, Secretary

Department of Natural Sciences
Shawnee State University
940 Second Street
Portsmouth, Ohio 45662-4344

Phone: (614) 355-2301

Fax: [614] 355-2596

E-mail: csexton@shawnee.edu

Degrees in Natural Science

Bachelor of Science

Biology

Biology, Environmental Science

Biology, Pre-Medicine

Chemistry

Chemistry, Environmental Science

Chemistry, Pre-Medicine

Natural Science, Biology

Natural Science, Biology, Elementary
Education

Natural Science, Biology, Environmental
Science

Natural Science, Chemistry

Natural Science, Chemistry, Elementary
Education

Natural Science, Chemistry, Environmental
Science

Minors

Biology

Environmental Science

Associate of Science

Associate of Individualized Studies

See page 62 of the current catalog for description.

Bachelor Degrees

■ **Special Note:** In addition to College of Arts and Sciences requirements, students must complete at least 16 credit hours in their major at Shawnee State.

Bachelor of Science in Biology

The bachelor of science degree in biology provides a broad intellectual foundation in the fundamentals of life science and is based on a philosophical commitment to relate modern life science to economic, environmental, and societal concerns. The degree requirements give you the opportunity to tailor your own program through a selection of courses in the fields of botany, zoology, ecology, systematics, and biomedical science. You may choose to concentrate in a specific field or become a broadly trained biologist by selecting a diversity of advanced courses. Our biology graduates are prepared for careers in business, industry, and government or for advanced degree programs in biological or biomedical fields.

Degree Requirements

General Education Program (48 Hours) 36 Hours

The General Education Program is composed of 48 credit hours of which 12 hours may be satisfied by the following chemistry, biology, and mathematics requirements. Those courses that will apply to the GEP include NTSC 110S, MATH 131, and one of the support sciences courses. Further information about the GEP is listed on page 55 of the current catalog or can be obtained from the dean's office.

Biology Curriculum 60 Hours

(contains 30 hours of required courses)

Mathematics and Support Sciences 40 Hours

General Electives 50 Hours

Minimum Hours Required 186 Hours

Biology Curriculum (60 Hours)

(Required courses listed, 30 hours)

Course No.	Course	Cr. Hrs.
BIOL 151	Principles of Biology	5
BIOL 202	Principles of Plant Biology	5

Biology Curriculum (cont'd.)

Course No.	Course	Cr. Hrs.
BIOL 203	Principles of Animal Biology	5
BIOL 330	Ecology	5
BIOL 340	Genetics	5
BIOL 432	Cell Biology	5

Biology Electives (30 Hours)

Within the 30 hours of required biology electives, you must complete a minimum of 20 hours numbered above the 300 level and 4 hours above the 400 level. Consult your faculty advisor when choosing biology electives.

Mathematics and Support Sciences (40 Hours)

MATH 130	Intermediate Algebra	4
MATH 131	College Algebra	4
MATH 150	Principles of Statistics OR Statistics 1	4
CHEM 141	General Chemistry 1	4
CHEM 142	General Chemistry 2	4
CHEM 143	General Chemistry 3	4
CHEM 200	Intro. to Organic Chemistry OR Organic Chemistry 1	4
NTSC 110S	Natural Science	4
PHYS ---	Physics Elective	4
	Computer Science Elective	4

Suggested Pre-Medicine Curriculum

If you are interested in pursuing a career in medicine or related fields, you should choose either a bachelor's degree in biology or chemistry. Pre-medicine students who choose a chemistry degree should follow the requirements prescribed under the bachelor of science degree in chemistry. For pre-medicine students who choose a biology degree, we suggest you take the following courses in the sequence shown below.

First Year — BIOL 151 Principles of Biology (5), BIOL 202 Principles of Plant Biology (5), BIOL 203 Principles of Animal Biology (5), and two mathematics courses based on placement testing.

Second Year — BIOL 310 Principles of Anatomy (5), BIOL 320 Principles of Physiology (5), BIOL 350 Microbiology (4), CHEM 141 General Chemistry 1 (4), CHEM 142 General Chemistry 2 (4), CHEM 143 General Chemistry 3 (4), and mathematics courses through MATH 202 Calculus 2 (4) and MATH 150 Principles of Statistics (4).

Third Year — BIOL 312 Sectional Anatomy (3), BIOL 314 Human Neuroanatomy (5), BIOL 330 Ecology (5), CHEM 305 Organic Chemistry 1 (4), CHEM 306 Organic Chemistry 2 (4), CHEM 307 Organic Chemistry 3 (4), PHYS 201 Physics 1 (4), PHYS 202 Physics 2 (4), PHYS 203 Physics 3 (4).

Fourth Year — BIOL 315 Histology (5), BIOL 340 Genetics (5), BIOL 410 Advanced Human Anatomy (5), BIOL 411 Biochemistry (4), BIOL 432 Cell Biology (5).

Bachelor of Science in Chemistry

The bachelor of science degree in chemistry is designed to prepare you for an entry level professional position in an industrial or government laboratory and for postgraduate chemistry programs. Shawnee State's curriculum has been designed using the standards of the American Chemical Society as guidelines. It provides a broad education in general, organic, inorganic, analytical, and physical chemistry, and includes specialized courses in environmental chemistry. If you graduate with a B.S. degree in chemistry, you are equipped with an understanding of how chemists synthesize new products as varied as pharmaceuticals and plastics; how they apply the scientific method and specific chemical knowledge to the detection and measurement of pollutants in the air, water, and soil; how chemistry contributes to our understanding of the material universe; and how knowledge of chemistry can contribute to the advancement of knowledge in any number of fields in which the properties of matter play a role.

Degree Requirements

General Education Program (48 Hours) 36 Hours

The General Education Program is composed of 48 credit hours of which 12 hours may be satisfied by the following chemistry, biology, and mathematics requirements. Those courses that will apply to the GEP include NTSC 110S, MATH 131, and one of the support sciences courses. Further information about the GEP is listed on page 55 of the current catalog or can be obtained from the dean's office.

Chemistry Curriculum 68 Hours

Mathematics and Support Sciences 49 Hours

General Electives 33 Hours

Minimum Hours Required 186 Hours

Chemistry Curriculum (68 Hours)

Course No.	Course	Cr. Hrs.
CHEM 141	General Chemistry 1	4
CHEM 142	General Chemistry 2	4
CHEM 143	General Chemistry 3	4
CHEM 305	Organic Chemistry 1	4
CHEM 306	Organic Chemistry 2	4
CHEM 307	Organic Chemistry 3	4
CHEM 323	Quantitative Analysis	5
CHEM 325	Instr. Meth. of Analysis	5
CHEM 331	Intro. to Physical Chemistry	4
CHEM 341	Intro. to Inorganic Chemistry	4
CHEM 350	Lit. and Info. Retrieval	2
CHEM 421	Environmental Chemistry 1	4
CHEM 422	Environmental Chemistry 2	4

Chemistry Curriculum (cont'd)

Course No.	Course	Cr. Hrs.
CHEM 432	Physical Chemistry 1	4
CHEM 433	Physical Chemistry 2	4
CHEM 441	Inorganic Chemistry	4
CHEM 495	Undergraduate Research	4

Mathematics and Support Sciences (49 Hours)

MATH 201	Calculus 1	4
MATH 202	Calculus 2	4
MATH 203	Calculus 3	4
MATH 204	Calculus 4	4
MATH 230	Linear Algebra	5
MATH 250	Statistics 1	4
MATH 301	Ordinary Diff. Equations	4
NTSC 110S	Natural Science	4
PHYS 211	Calculus Based Physics 1	4
PHYS 212	Calculus Based Physics 2	4
PHYS 213	Calculus Based Physics 3	4
	Computer Science Elective	4

General Electives (33 Hours)

Choose elective courses in any discipline. You should consider taking elective courses that form a coherent whole and that complement your chemistry courses. For example, courses in economics, marketing, and business may help the practicing chemist to relate his or her research to its social context. As a complement to environmental chemistry, you might consider elective courses in biology, geology, geography, and other disciplines that bear on environmental issues. The mathematics requirement of the chemistry degree program is rigorous; it begins with Calculus 1. Since you may not be ready for calculus when you enter the University, you may take college algebra and trigonometry/analytical geometry during your first year and receive elective credit for these courses. It is recommended that you consult with your academic advisor about your choice of elective courses.

Bachelor of Science in Natural Science

Graduates who are well versed in science and mathematics are in demand in business, government, education, and industry. Evidence suggests that this demand will increase in the future as the world becomes more technologically sophisticated. In order to meet that demand, Shawnee State's bachelor of science in natural science has been designed to provide you with a foundation, well grounded in the sciences

and mathematics, which allows for a variety of career options.

The degree program requires you to study in three different disciplines of science and/or mathematics, offering the kind of flexibility that prepares you for a career in the life, physical, or environmental sciences. In addition, the degree program offers a solid foundation for continuing your education in these fields or in the medical sciences. If you wish to teach school at the elementary level, requirements for certification can be completed concurrently with the degree program in natural science. You should discuss your options with your faculty advisor.

Degree Requirements**General Education Program (48 Hours) 36 Hours**

The General Education Program is composed of 48 credit hours of which 12 hours may be satisfied by the following chemistry, biology, and mathematics requirements. Those courses that will apply to the GEP include NTSC 110S, MATH 131, and one of the support sciences courses. Further information about the GEP is listed on page 55 of the current catalog or can be obtained from the dean's office.

Concentration Area 1 Biology or chemistry courses above 110 (Required: BIOL 151, 202, 203 OR CHEM 141, 142, 143 and at least 12 hours above the 300 level), 32 hours. Senior Project, 4 hours 36 Hours**Concentration Area 2 Biology, chemistry, geology, mathematics, or physics courses numbered above 110 16 Hours****Concentration Area 3 Biology, chemistry, geology, mathematics, or physics courses numbered above 110 8 Hours****NTSC 110S Natural Science 4 Hours****Humanities/Social Science Electives 24 Hours**

Courses with prefixes (excluding GEP courses) — SOCI, GEOG, GOVT, PSYC, ECON, HIST, ANTH, ENGL, PHIL, LING, SPCH, THAR, SPAN, ARTS, MUSI, JOUR, FREN

Mathematics Electives MATH 130 or above; MATH 140, 141 (for elementary education students) 8 Hours**Computer Science Elective 4 Hours****General Electives 50 Hours****Minimum Hours Required 186 Hours**

EXAMPLE 1: (actual program may vary)

Bachelor of Science in Natural Science with Concentration in Chemistry**General Education Program (48 Hours) 36 Hours****Concentration 1 (in chemistry) 37 Hours**

CHEM 141, 142, 143, 305, 306, 307, 323, 331, 485

EXAMPLE 1 (cont'd.)

Concentration 2 (in mathematics) <i>MATH 132, 201, 202, 203</i>	16 Hours
Concentration 3 (in physics) <i>PHYS 211, 212</i>	8 Hours
NTSC 110S	4 Hours
Human./Soc. Sc. Electives <i>Courses with prefixes (excluding GEP courses)—SOCI, GEOG, GOVT, PSYC, ECON, HIST, ANTH, ENGL, PHIL, LING, SPCH, THAR, SPAN, ARTS, MUSI, JOUR, FREN. (You may take several courses in one of these disciplines.)</i>	24 Hours
Mathematics Electives <i>MATH 130, 131</i>	8 Hours
Computer Science Elective <i>BUIS 101 or BUAI 101</i>	4 Hours
General Electives <i>CHEM 325, 341, 432, 433, PHYS 213 and other hours as needed. (General electives may be selected from a variety of disciplines; for example additional hours in biology, geology, computer science, or other disciplines may be appropriate.)</i>	50 Hours

Elementary Education Certification

Students seeking a bachelor of science in natural science who wish to be certified in elementary education must also complete the requirements listed below. It is important to note that these requirements are not entirely in addition to the bachelor of science degree but rather meet certain electives, such as the mathematics requirement, humanities/social science electives, and general electives. Some additional hours are necessary to meet all of the requirements. You are urged to discuss the elementary education option with your primary advisor in the Department of Natural Sciences and your advisor in the Center for Teacher Education.

Degree Requirements

General Education Program (48 Hours) <i>The General Education Program is composed of 48 credit hours of which 12 hours may be satisfied by the following science and mathematics requirements. Further information is listed on page 55 of the current catalog or can be obtained from the dean's office.</i>	36 Hours
Concentration Area 1 <i>Biology or chemistry courses (above 110 and at least 12 hours above the 300 level), 32 hours. Senior Project, 4 hours</i>	36 Hours

Concentration Area 2 <i>Biology, chemistry, geology, physics, or mathematics courses numbered above 110</i>	16 Hours
Concentration Area 3 <i>Biology, chemistry, geology, physics, or mathematics courses numbered above 110</i>	8 Hours
NTSC 110S	4 Hours
Computer Science Elective	4 Hours
Arts and Sciences Requirements <i>Listed on page 95 of the current catalog or available from the dean's office.</i>	37 Hours
Professional Education Require. <i>Listed on page 94 of the current catalog or available from the dean's office</i>	55 Hours
Minimum Hours Required	196 Hours

EXAMPLE 2: (actual program may vary)

Bachelor of Science in Natural Science with Concentration in Biology and Certification in Elementary Education

General Education Program (48 Hours)	36 Hours
Concentration 1 (in biology) <i>BIOL 151, 202, 203, 307, 330, 340, 370, 485</i>	39 Hours
Concentration 2 (in geology) <i>GEOL 111, 112, 201, 202</i>	16 Hours
Concentration 3 (in chemistry) <i>CHEM 121, 122</i>	8 Hours
NTSC 110S	4 Hours
Computer Science Elective <i>BUIS 101 or BUAI 101</i>	4 Hours
Arts and Sciences Requirements <i>ARTS 201, 202, HPER 202, 270, MUSI 160, 161, MATH 140, 141, PSYC 375, SPCH 103</i>	37 Hours
Professional Education Requirements <i>EDUC 110, 210, 220, 230, 240, 310, 340, 420, 421, 450</i>	55 Hours

Certificate

Certificate in Environmental Science, BS Degree

A certificate in environmental science offers you the opportunity to focus your study on basic and environmental sciences if you are enrolled in the bachelor of science in natural science, in chemistry, or in biology. The certificate requires a set of thirteen science and environmental courses; Concentration 1, in either biology or chemistry; and an environmentally related senior project. Many students who select this

option also complete an internship to gain experience working in an environmentally related job.

Required Courses (54 Hours)

BIOL 151	Principles of Biology
BIOL 330	Ecology
CHEM 141	General Chemistry 1
CHEM 142	General Chemistry 2
CHEM 143	General Chemistry 3
CHEM 323	Quantitative Analysis or
CHEM 421	Environmental Chemistry 1
GEOG 311	Geography of Air Pollution
GEOL 112	Environmental Geology
GEOL 201	Physical Geology
MATH 201	Calculus 1
MATH 250	Statistics 1
NTSC 240	Intro. to Environmental Science
PHYS 203	Physics of Energy

EXAMPLE 3: (actual program may vary)

Bachelor of Science in Natural Science with Concentration in Biology and Certification in Environmental Science

General Education Program (48 Hours)	36 Hours
Concentration 1 (in biology) <i>BIOL 151, 202, 203, 330, 331, 350, 370, 485</i>	39 Hours
Concentration 2 (in chemistry) <i>CHEM 141, 142, 143, 323 or 421</i>	16 Hours
Concentration 3 (in geology) <i>GEOL 112, 201</i>	8 Hours
NTSC 110S	4 Hours
Mathematics Requirements <i>MATH 201, 250</i>	8 Hours
Computer Science Elective <i>BUIS 101 or BUAI 101</i>	4 Hours
Human./Soc. Sc. Electives <i>ECON 101, ENGL 121, GEOG 311, 350, 404, GOVT 401, PHIL 334</i>	27 Hours
General Electives <i>CHEM 305, 306, 307, 325, MATH 350, NTSC 240, PHYS 203 and other hours as needed. Consult your faculty advisor.</i>	50 Hours

For additional information about the environmental science certificate, write or call: Environmental Science Coordinator, Natural Science Department, (614) 355-2301.

Minors

ATTENTION: See your Department of Natural Sciences faculty advisor.

Biology Minor

In addition to the major program in biology, the Department of Natural Sciences offers a minor in biology, which may be completed along with any of the University's baccalaureate programs.

Requirements for the biology minor consist of a minimum of 30 credit hours in biology and include:

BIOL 151, 202, and 203	15 Hours
BIOL 330 or 340 or 432	5 Hours
Biology Electives (At least one course numbered above 300.)	10 Hours

Environmental Science Minor

In response to national demands for the 'greening' of government, business, and industry, many job descriptions now request an educational background that includes environmentally related coursework. As you graduate and enter the workforce, the environmental science minor can represent that extra educational experience that helps you obtain the job of your choice.

The minor in environmental science is designed for students in degree programs other than natural science in biology and chemistry. It offers you the opportunity to broaden your major course of study with an auxiliary focus in basic and environmental sciences. The minor requires six courses (23-28 credit hours) from at least three departments. Natural science students desiring an environmental emphasis should consider the certificate in environmental science.

Required Courses (16-17 Hours)

One course in biology (BIOL 151 or another introductory course)
One course in chemistry (CHEM 121 or CHEM 141)
NTSC 240 Introduction to Environmental Science
GEOL 112 Environmental Geology

Elective Courses (7-8 Hours)

Two additional courses from the following list:

BIOL 202 Principles of Plant Biology, BIOL 203 Principles of Animal Biology, BIOL 210 Taxonomy of Vascular Plants, BIOL 271 Field Ornithology, BIOL 272 Ohio's Natural

Heritage, BIOL 302 Dendrology, BIOL 303 Spring Flora, BIOL 307 General Entomology, BIOL 330 Ecology, BIOL 331 Advanced Field Biology, BIOL 350 Microbiology, BIOL 365 Phycology, BIOL 370 Marine Biology, CHEM 122 Introduction to General Chemistry 2, CHEM 142 General Chemistry 2, CHEM 200 Introduction to Organic Chemistry, GEOG 311 Geography of Air Pollution, GEOL 201 Physical Geology, GEOL 202 Historical Geology, GOVT 401 State of the World, PHIL 202 Environmental Ethics

New Programs

Faculty in the Department of Natural Sciences are developing a new baccalaureate program in environmental science.

Faculty have developed secondary education certification programs in **biological science**, **chemistry**, **earth science**, and **general science** in conjunction with our existing degree. These programs may be available prior to the next edition of the Shawnee State catalog. Please contact your advisor or the chairperson of the Department of Natural Sciences for further information.

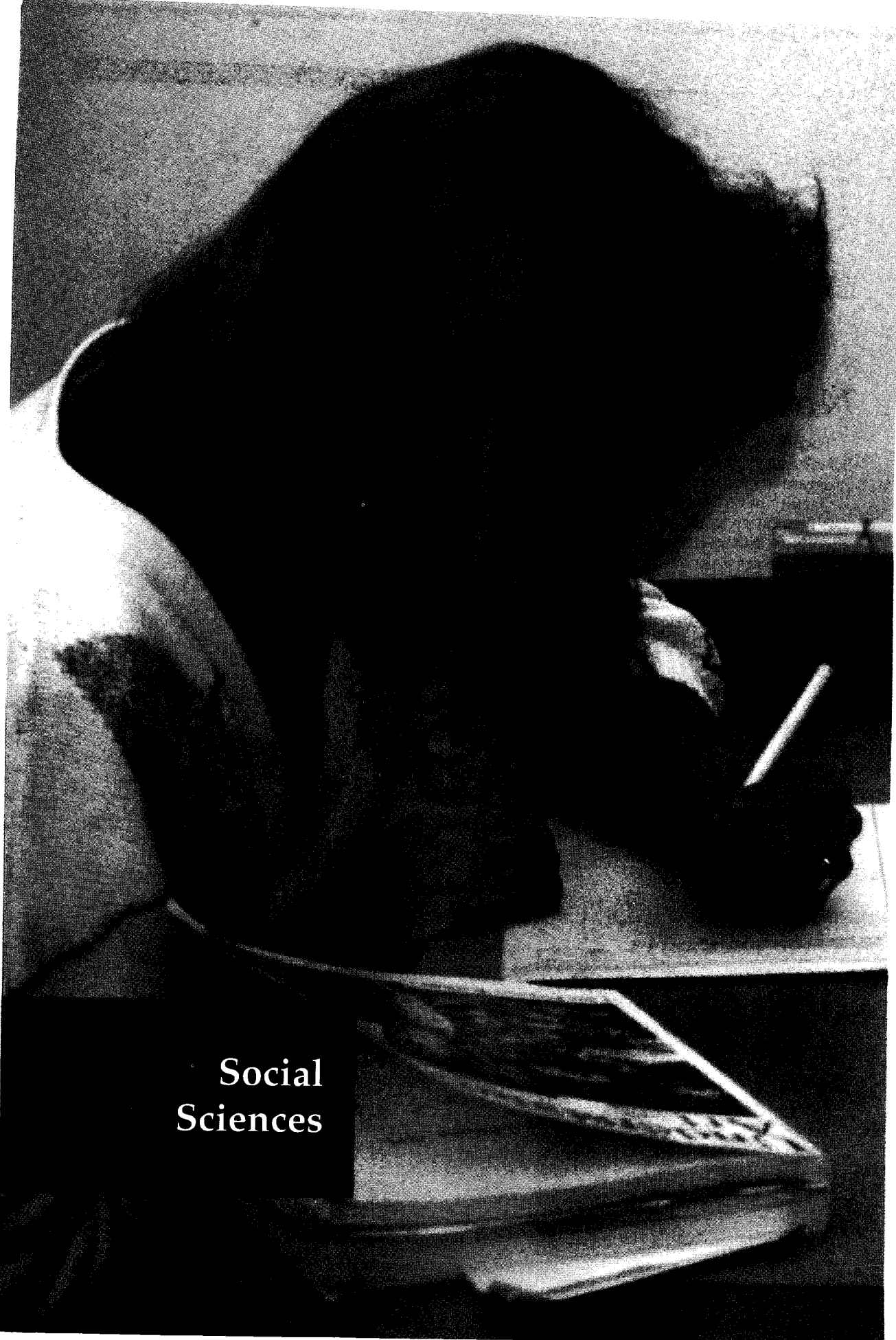

Social
Sciences

Social Sciences

The Department of Social Sciences provides general education students a sense of the importance of cultural influences, a sense of history within the scope of changing cultural themes, and a sense of their own worth as human beings. These understandings are refined through a sound curriculum in the behavioral sciences, which explains variations in human behavior based on theoretical models, instruction in research methods used by contemporary social scientists, and a special focus on interdisciplinary connections among topical social issues.

For More Information

Edward C. Miner, Ph.D., Chairperson
Sandra S. Delabar, Secretary

Department of Social Sciences
Shawnee State University
940 Second Street
Portsmouth, Ohio 45662-4344

Phone: (614) 355-2234

Fax: [614] 355-2416

E-mail: eminer@shawnee.edu
sdelabar@shawnee.edu

Degrees in Social Science

Bachelor of Arts

History
International Relations
Social Sciences
Social Sciences, Elementary Education
Social Sciences, Legal Assisting (2+2)

Minors

Economics
Geography
History
Political Science
Psychology
Sociology

Associate of Arts
Social Science

Associate of Individualized Studies
See page 62 of the current catalog for description.

Bachelor Degrees

Bachelor of Arts with a Major in History

The Department of Social Sciences' history program provides students with a general understanding of the development of American, western, and select non-western civilizations. Special attention is given to 20th century history, the problems of modernization, and the increasing connections between societies. In developing these understandings, you learn to draw upon the insights and techniques of cognate social science disciplines.

The program encourages you to develop your analytical capacities, research skills, and writing talents, which, in turn, stand you in good stead as you pursue a career in law, education, journalism, government service, or the private sector.

Degree Requirements

General Education Program	48 Hours
<i>Further information is listed on page 55 of the current catalog or can be obtained from the dean's office.</i>	
History Survey Courses	24 Hours
History Upper-Division Courses (300-400 Level)	24 Hours
Social Science Upper-Division Cognate Courses (from following list)	12 Hours
Elective Courses	78 Hours
Total Hours Required	186 hours

History Survey Courses (24 Hours)

<i>The following courses must be completed with a minimum grade of "C."</i>	
HIST 111, 112, and 113 (American Survey)	12 Hours
HIST 201, 202, and 203 (European Survey)	12 Hours

History Upper-Division Courses (24 Hours)

A minimum grade of "C" must be achieved in any course used to fulfill this degree requirement.

Two U.S. history courses from:

Course No.	Course	Cr. Hrs.
HIST 301	Form. of the Nation, 1750-1815	4
HIST 305	From FDR to Reagan	4
HIST 320	Hist. of Amer. Foreign Relations	4
HIST 326	Economic History of the U.S.	4

Two upper-division European courses from:

HIST 310	Nazi Germany	4
HIST 325	History of Russia	4
HIST 401	History of Medicine	4
HIST 410	Intellectual History 1	4
HIST 411	Intellectual History 2	4

Two upper-division non-western courses from:

ANTH 340	Meso-Amer. Before Columbus	4
HIST 330	History of South Africa	4
HIST 371	Islamic Culture and Civilization	4
HIST 420	Middle East in Modern Times	4

Social Science Upper-Division Cognate Courses (12 Hours)

A minimum grade of "C" must be achieved in any course used to fulfill this degree requirement.

ANTH 360	Indians of North America	4
ECON 405	Economic Development	4
ECON 411	Comparative Economic Systems	4
GEOG 310	Medical Geography	4
GEOG 350	Geography of North America	4
GEOG 351	Regional Geog. of the Mid. East	4
GOVT 310	American Foreign Policy	4
GOVT 320	Third World Politics	4
GOVT 330	Mass Media Politics	4
GOVT 340	European Politics	4
GOVT 350	National Public Policy	4
GOVT 401	State of the World	4
GOVT 420	International Political Economy	4
SOCI 312	Sociology of Religion	4
SOCI 330	Social Theory	4
SOCI 340	Sociology of Appalachia	4
SOCI 380	Sociological Methods	4

Elective Courses (78 Hours)

You are free to select courses from any of the University's offerings that you find useful. Faculty advisors are happy to offer suggestions on what areas of study might be particularly beneficial to you.

Bachelor of Arts with a Major in International Relations

The international relations degree examines the nature of the global economy, communications, politics, and cultures; the consequences of the increasing environmental interdependence among regions of the world; and the unfolding

of a variety of other crossborder issues. The program aims to provide its graduates with the conceptual and substantive tools necessary to function more advantageously and effectively in a "shrinking" world; the global village concept. The degree consists of courses from many academic disciplines such as government, economics, business, history, and sociology, and contains a foreign language requirement.

Careers

Graduates can opt for careers in local, state, national, and international government institutions or in trade and commerce chambers or in professional associations or other nongovernmental agencies such as contracting and consulting firms, nonprofit organizations, foundations and research establishments, and political support and interest groups. Careers are also possible in the growing national and international tourist industry or in international business and finance, print and broadcast media, public relations, and advertising firms. Graduates can also pursue a variety of related graduate studies (i.e., international relations, political science, law).

Degree Requirements

General Education Program	48 Hours
<i>Further information is listed on page 55 of the current catalog or can be obtained from the dean's office.</i>	
International Relations Courses	20 Hours
Cognate Concentrations	36 Hours
Foreign Language	12 Hours
University Electives	70 Hours
Total Hours Required	186 Hours

International Relations Courses (20 Hours)

Course No.	Course	Cr. Hrs.
GOVT 310	United States Foreign Policy OR	4
HIST 320	History of Am. Foreign Relations	
GOVT 320	Third World Politics	4
GOVT 370	Global Politics	4
GOVT 401	State of the World	4
GOVT 420	International Political Economy	4

Cognate Concentrations (36 Hours)**POLITICAL SCIENCE**

GOVT 250	Intro. to Political Science	4
<i>And a choice of one of the following:</i>		
GOVT 101	National Government	4
GOVT 240	Contemp. Political Ideologies	4
GOVT 330	Mass Media Politics	4

POLITICAL SCIENCE (cont'd.)

Course No.	Course	Cr. Hrs.
GOVT 340	European Politics	4
GOVT 350	National Policy Issues	4
GOVT 399	Special Topics in Government OR	4
GOVT 499	Special Topics in Government	

ECONOMICS

ECON 101	Principles of Economics 1	4
ECON 102	Principles of Economics 2	4

And a choice of two of the following:

BUMG 340	International Business	4
BUMK 315	International Marketing	4
ECON 411	Comparative Economic Systems	4
ECON 450	International Trade	4

HISTORY

Choose one from the following:

HIST 310	Nazi Germany	4
HIST 325	History of Russia	4
HIST 330	History of Southern Africa	4
HIST 420	Middle East in Modern Times	4

GEOGRAPHY

Choose one from the following:

GEOG 125	World Geography	4
GEOG 201	Cultural Geography	4
GEOG 350	Regional Geography, N. America	4
GEOG 351	Regional Geography, Middle East	4

ANTHROPOLOGY AND SOCIOLOGY

Choose one from the following:

ANTH 250	Prin. of Cultural Anthropology	4
ANTH 371	Islamic Religion, Culture, & Civil.	4
SOCI 250	Current Social Problems	4
SOCI 312	Sociology of Religion	4
SOCI 410	Social Stratification	4

Foreign Language Requirement (12 Hours)

Any sequence of three courses in one language.

SPAN 111	Elementary Spanish 1	4
SPAN 112	Elementary Spanish 2	4
SPAN 113	Elementary Spanish 3	4
SPAN 211	Intermediate Spanish 1	4
SPAN 212	Intermediate Spanish 2	4
SPAN 213	Intermediate Spanish 3	4
FREN 111	Elementary French 1	4
FREN 112	Elementary French 2	4
FREN 113	Elementary French 3	4

Elective Courses (70 Hours)

You may select from the broad spectrum of university courses or choose courses in the social sciences, business, and the humanities, especially foreign language. It is recommended that students consider minoring in economics, history, or business.

Bachelor of Arts with a Major in Social Science

The general social science major requires 36 hours of social science core courses. You must achieve a minimum grade of "C" in each required social science course in order to graduate.

Degree Requirements

General Education Program	48 Hours
<i>Social science majors must take SOCI 110S to fulfill the GEP social science requirement. Further information is listed on page 55 of the current catalog or can be obtained from the dean's office.</i>	
Social Science Core Courses	36 Hours
Upper Division Social Science Electives (300-400 level)	36 Hours
Elective Courses	66 Hours
Total Hours Required	186 Hours

Social Science Core Courses (36 Hours)

Course No.	Course	Cr. Hrs.
PSYC 101	Introduction to Psychology	4
SOCI 101	Introduction to Sociology	4
GOVT 250	Introduction to Political Science	4
ECON 101	Prin. of Macro. (or ECON 102)	4
ANTH 250	Prin. of Cult. Anth. (or GEOG 125 or GEOG 130 or GEOG 201)	4
HIST 111	American History (or HIST 112 or HIST 113)	4
HIST 201	Ancient or Eur. Hist. (or HIST 202 or HIST 203)	4
PSYC 273	Psych. of Human Adjustment	4
GOVT 401	State of the World	4

Elective Courses (66 Hours)

Although electives may be chosen from the broad spectrum of university courses, you may choose to take your electives within the social science department (anthropology, geography, history, political science, psychology, and sociology) and pursue a broad emphasis in social science. With this approach, you acquire a comprehensive background in the social sciences. It is suggested that you take 8 to 12 hours from each of the following areas:

- History
- Economics
- Geography
- Government
- Psychology
- Sociology/Anthropology

Social Science Major with Elementary Education Certification

If you are majoring in social science and you wish to complete requirements toward certification in elementary education, you may choose a

special program which was designed to meet your needs. In this curriculum, you take courses which cover subject matter traditionally taught as social studies in the elementary school.

In addition to the teacher education requirements, the social science department requires a minimum grade of "C" in each required social science course in order to graduate.

Students choosing elementary education certification are urged to work closely with their social science advisor and with an advisor from the elementary education program.

Degree Requirements

General Education Program	48 Hours
<i>Social science majors must take SOCI 110S to fulfill the GEP social science requirement. Further information is listed on page 55 of the current catalog or can be obtained from the dean's office.</i>	
Social Science Requirements	60 Hours
Arts and Sciences Requirements	37 Hours
<i>Listed on page 95 of the current catalog or available from the dean's office.</i>	
Professional Education Require.	55 Hours
<i>Listed on page 94 of the current catalog or available from the dean's office.</i>	
Total Hours Required	200 Hours

Social Science Requirements (60 Hours)

Course No.	Course	Cr. Hrs.
SOCI 101	Introduction to Sociology	4
PSYC 101	Introduction to Psychology	4
HIST 111	American History to 1828	4
HIST 112	American History, 1828-1900	4
HIST 113	American History Since 1900	4
PSYC 273	Psych. of Human Adjustment	4
HIST 201	Ancient History (or HIST 202 or HIST 203)	4
GEOG 125	World Geography (or GEOG 201 or GEOG 225)	4
ECON 101	Prin. of Macro. (or ECON 102)	4
GOVT 250	Intro. to Political Science	4
PSYC 310	Child Psych. (or PSYC 316)	4
SOCI 310	Gender Socialization	4
GOVT 401	State of the World	4
	Social Science Electives	8

Bachelor of Arts in Social Sciences

2+2 for Students Who Complete the Legal Assisting Program

This program is designed for students who have completed the associate degree in legal assisting at Shawnee State and who wish to

pursue a baccalaureate degree as preparation for law school. All required courses in the legal assisting program (99 credit hours) count toward the baccalaureate requirements. To be awarded the bachelor degree, you must complete an additional 32 hours of General Education Program requirements, 28 hours of Social Science Core requirements, and 32 hours in social science at the 300-400 level. The entire program requires completion of 191 credit hours. You must achieve a minimum grade of "C" in each required social science course in order to graduate.

Degree Requirements

Completion of Legal Assist. Prog.	99 Hours
Additional General Ed. Program	36 Hours
Additional Soc. Sc. Core Courses	28 Hours
Upper Division Soc. Sc. Electives (300-400 level)	32 Hours
Total Hours Required	195 Hours

Legal Assisting Curriculum (99 Hours)

Includes certain courses that are part of either the General Education Program or the Social Science Core. (Refer to page 114 of the current catalog or contact the dean of the College of Professional Studies for more information).

Additional General Education Program (36 Hours)

This is the maximum number of hours. With doublecounting, the hours required may actually be less. Some General Education Program courses have already been taken within the legal assisting associate degree program. Please see your advisor to determine specifically what is required.

Additional Social Science Core (28 Hours)

Course No.	Course	Cr. Hrs.
SOCI 101	Introduction to Sociology	4
ECON 101	Prin. of Macro. (or ECON 102)	4
HIST 111	Amer. Hist. (or HIST 112 or 113)	4
HIST 201	Ancient or Eur. Hist. (or HIST 202 or 203)	4
PSYC 273	Psych. of Human Adjustment	4
GEOG 125	World Geography (or GEOG 130 or 201 or ANTH 250)	4
GOVT 401	State of the World	4

Upper Division Social Science Electives (32 Hours)

Select 32 credit hours of upper division social science electives (courses in anthropology, economics, geography, government, history, psychology, and/or sociology) in consultation with your faculty advisor.

Minors

Economics Minor

A minor in economics offers students enrolled in any of Shawnee State University's baccalaureate programs an opportunity to broaden their course of study with an auxiliary focus in economics. This is especially appealing to students interested in careers in banking, law, finance, or government service.

The minor requires you to complete 24 credit hours of economics, with a minimum grade of "C." No more than 12 of these hours may count toward your major(s), and since ECON 101 and 102 are prerequisites for all upper-level economics courses, these are required for the minor. Any four additional upper-level economics courses will satisfy the hours requirement.

Geography Minor

Students enrolled in a baccalaureate degree program in most arts and science and business majors may elect to complete a minor in geography. This may be an appropriate minor if you are interested in a career in marketing, tourism, environment, city planning, teaching, or the military.

The minor in geography requires the completion of 28 hours in geography. No grade below a C- will be permitted to count toward completion. Courses taken on a pass/no-credit basis may not be applied to the minor.

Requirements

The following three courses are required (12 hours):

GEOG 125	World Geography
GEOG 201	Cultural Geography
GEOG 225	Physical Geography

Select one of the following (4 hours):

GEOG 130	Economic Geography
GEOG 230	Urban Geography
GEOG 242	Geography of Ohio

Select three of the following (12 hours):

GEOG 310	Medical Geography
GEOG 311	Air Pollution
GEOG 350	Regional Geography: North America
GEOG 351	Regional Geography: Middle East
GEOG 404	Transportation Geography and Mgt.

Other upper division geography courses as available.

History Minor

Students enrolled in any of the University's baccalaureate degree programs may elect to complete a minor in history. This may be a particularly attractive program for those majoring in English/humanities, social sciences, or business and for those planning to attend law school.

The minor requires you to complete 28 hours of history, with a minimum grade of "C." Courses taken on a pass/no-credit basis may not be applied to the minor.

Requirements

American History Survey Courses (8 Hours)

Select two

HIST 111	American History to 1828
HIST 112	American History, 1828-1900
HIST 113	American History Since 1900

European History Survey Courses (8 Hours)

Select two

HIST 201	Ancient History
HIST 202	Medieval and Early Modern Europe
HIST 203	Modern Europe

Upper-Level History Courses (12 Hours)

Select three courses, with no more than two courses from the same field. Note: both the number of fields and available courses within them may increase as the program develops.

Field One (U.S. History)

HIST 301	Form. of the Am. Nation, 1750-1815
HIST 305	From FDR to Reagan
HIST 320	Hist. of American Foreign Relations
HIST 326	Economic History of the U.S.

Field Two (European History)

HIST 310	Nazi Germany
HIST 325	History of Russia
HIST 401	History of Medicine
HIST 410	Intellectual History 1
HIST 411	Intellectual History 2

Field Three (Non-Western History)

ANTH 340	MesoAmerica Before Columbus
HIST 330	History of South Africa
HIST 371	Islamic Culture and Civilization
HIST 420	Middle East in Modern Times

Political Science Minor

A minor in political science may be an appropriate choice for students pursuing a baccalaureate degree in most arts and science and business majors or for students interested in a career in the public sector, in journalism, public relations, trade, professional and research organizations, foundations, consulting and contracting firms, or political support groups.

The minor requires you to complete 24 hours in political science, with a minimum grade of "C" in any of the courses selected from the list below. You are subject to all applicable baccalaureate degree and curricula rules and restrictions issued by the academic departments and the General Education Program.

Requirements

Choose any six courses from the list below. (Each is 4 credit hours.)

GOVT 101	National Government
GOVT 240	Contemporary Political Ideologies
GOVT 310	United States Foreign Policy
GOVT 320	Third World Politics
GOVT 330	Mass Media Politics
GOVT 340	European Politics
GOVT 350	National Policy Issues
GOVT 370	Global Politics
GOVT 420	International Political Economy

Psychology Minor

Graduates with a minor in psychology make attractive employment prospects because of their familiarity with the human condition. The American Psychological Association and the Occupational Outlook Handbook indicate that future employment opportunities for individuals with a psychology background may be found in business, industry, social services, marketing, public relations, criminology, and the health service field.

A "C" or better must be earned in the minor. Courses taken on a pass/no-credit basis do not count toward the minor. Any variation from the program must have the chairperson's approval.

Students are encouraged to take Principles of Statistics (MATH/PSYC 150), Experimental Psychology (PSYC 499), and Psychological Study of Contemporary Problems (PSYC 475).

You may not double count more than 12 credit hours of psychology taken in your major toward the minor in psychology.

Requirements (28 Hours)

PSYC 101	Introduction to Psychology
PSYC 151	Human Growth and Development
PSYC 290	Psychological Tests and Measurements
PSYC XXX	Electives (16 credit hours with a minimum of 8 hours at the 300-400 level which relate to the student's area of interest.)

Sociology Minor

Students majoring in any discipline may choose to minor in sociology, which allows them to build a concentration in a behavioral science that dovetails well with their career ambitions, thus enhancing the marketability of their degree.

Sociology provides an excellent background for the development of careers in law, journalism, social services, recreation, counseling, and business.

Requirements

Students must complete 28 hours of sociology courses. No more than 12 credit hours of sociology, from any BA degree, may be double counted toward the minor in sociology. Courses with grades below a "C" will not be counted toward the completion of the minor in sociology. Courses taken on a pass/no-credit basis are not applicable. Any variation from the program described requires advisor and chair approval. Students are encouraged to take MATH/PSYC 150, Principles of Statistics.

Required Courses

SOCI 101	Introduction to Sociology
SOCI 205	Current Social Problems
SOCI 206	Social Institutions
SOCI 310	Gender Socialization OR
SOCI 410	Social Stratification

And select one from each of the following groupings.

GROUP 1

SOCI 224	Urban Sociology
SOCI 303	Introduction to Social Psychology
SOCI 307	Sociology of Work

GROUP 2

SOCI 310	Gender Socialization
SOCI 311	Human Sexuality
SOCI 325	Sociology of the Family
SOCI 405	Death and Dying

GROUP 3

ANTH 250	Principles of Cultural Anthropology
SOCI 312	Sociology of Religion
SOCI 320	Sociology of Culture
SOCI 340	Sociology of Appalachia
SOCI 429	Contemporary Minority Relations

New Degree Programs

Faculty in the Department of Social Sciences are developing several new majors, minors, and concentrations. All are in various stages of the approval process, and some may be available prior to the next edition of the Shawnee State catalog.

Currently under consideration are concentrations/minors in organizations, human resource development/human services, criminal justice/corrections, and a major in psychology. A major in sociology is awaiting final approval. A secondary education certification program, in conjunction with our existing baccalaureate degree in social sciences, is also being developed.

Please contact your advisor or the chairperson of the Department of Social Sciences for further information.

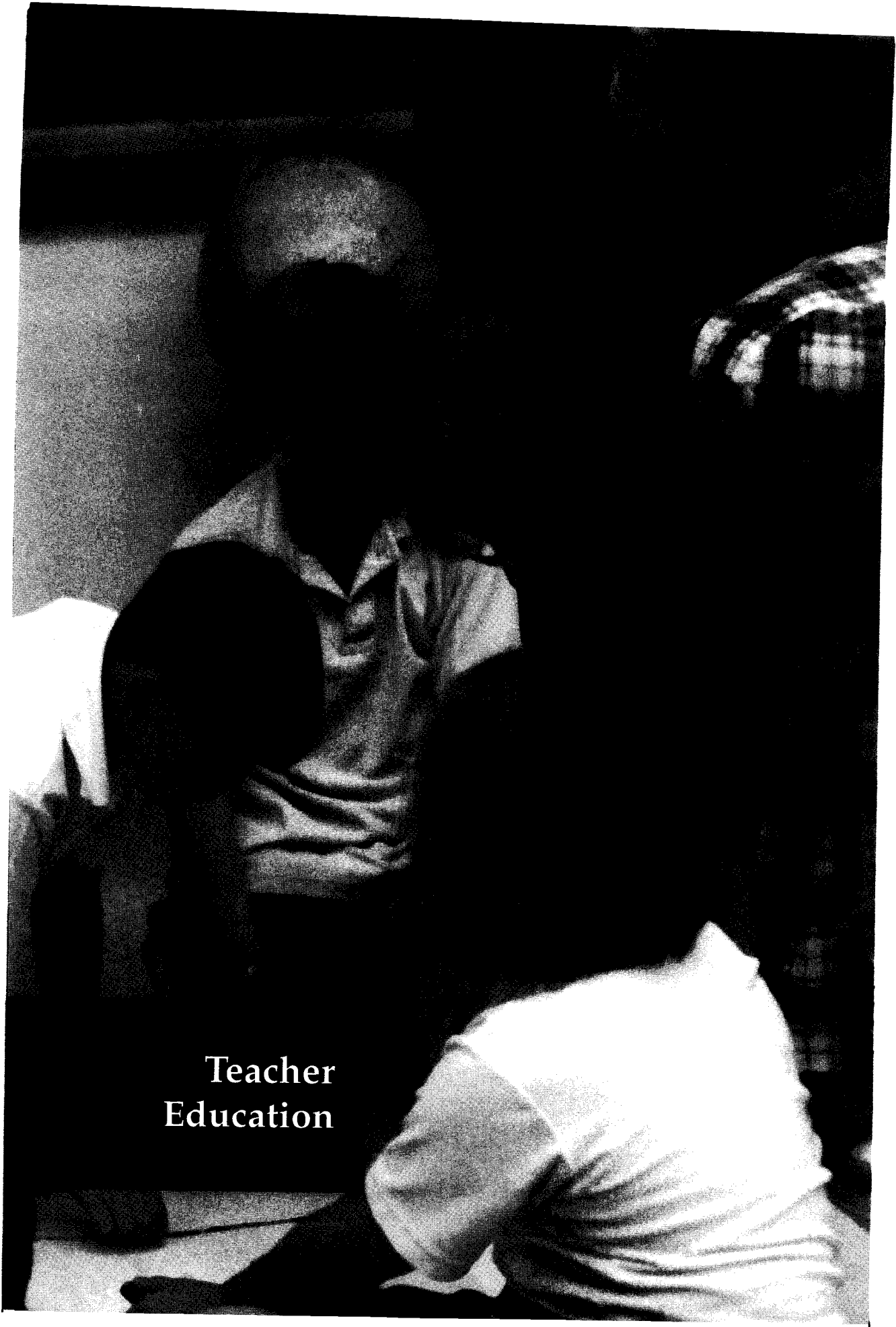

**Teacher
Education**

Teacher Education

The Department of Teacher Education prepares students for careers as elementary or secondary school teachers or for careers in areas related to health, recreation, and physical fitness. The Department also offers a reading education program that leads to a reading endorsement for Shawnee State students enrolled in the teacher education program or for educators who are currently teaching in the classroom.

For More Information

William Christen, Ed.D., Chairperson
Sharon Gannon, Secretary
Department of Teacher Education
Shawnee State University
940 Second Street
Portsmouth, Ohio 45662-4344
Phone: (614) 355-2451
Fax: [614] 355-2596
E-mail: sgannon@shawnee.edu

Degrees and Certification Offered by the Department of Teacher Education

Bachelor of Science

Sports Studies, Athletic Training
Sports Studies, Sports Management

Elementary Education Certification

in conjunction with Shawnee State University's
Bachelor of Arts in English/Humanities
Bachelor of Arts in Social Science
Bachelor of Science in Natural Science
Bachelor of Science in Natural Science,
Mathematics

Secondary Education Certification

in conjunction with Shawnee State University's
Bachelor of Science in Mathematical Sciences
Bachelor of Science in Natural Science,
Mathematics

K-12 Certification

in conjunction with Shawnee State University's
Bachelor of Fine Arts

Reading Endorsement

Elementary and Secondary Education Certification

Shawnee State University's teacher education program combines the breadth of the liberal arts and the depth of the academic discipline with the rigor of a professional development program to prepare the entry level teacher to meet the dynamic responsibilities of contemporary schools.

The vision of teaching which guides the teacher education program at Shawnee State is that of a reflective and inquiring professional. Assuming that teachers continue to develop over time cognitively, technically, and professionally, our program emphasizes lifelong learning in addition to the acquisition of specific skills and knowledge.

From your freshman year on, the program's theme of practice-centered inquiry is developed. The combination of the University's general education program and an in-depth academic major extends your knowledge of your chosen discipline to an understanding of how you learn that discipline. The professional sequence then provides directions for developing the strategies and skills you need to teach the discipline in light of how students learn. The education program provides a well-articulated arrangement of field and clinical activities, beginning with a set of exercises designed to screen students for desired teacher qualities and culminating in student teaching experiences which assess your professional competence and potential.

During your senior year, you engage in the integrative study of core methods. Specified themes provide interrelatedness not only within the blocks but between and among the other courses in the professional sequence. Foundational studies occur throughout the program

and, in fact, serve as a major clarifying and culminating activity. Throughout the program, the emphasis is on structured inquiry and reflection.

The certification program seeks to lead you to a greater mastery of a teaching specialization, an increased understanding of the liberal arts perspective, a wider context within which to make good choices, a research-based professional education core, and a greater sense of the need to contribute your abilities to the present community through your service and to future communities through your students' lives.

Eligibility Criteria for Admission to the Teacher Education Program

- Successful completion of at least 45 credit hours of coursework.
- Cumulative GPA of 2.50.
- Completion of specified general education program courses with a grade of "C" or higher. (See Teacher Education Policy Handbook.)
- Completion of specified professional education/related studies courses with a 3.0 GPA or higher.
- GPA of 3.0 or higher in courses completed in liberal arts/sciences major.
- Successful evaluation of completed field experiences.
- Successful completion of required entrance exams.

Certification Requirements

- Apply for and receive admission to the teacher education program.
- Complete an arts and sciences degree with a major in English/humanities, natural sciences, mathematical sciences, or social sciences with an emphasis in elementary or secondary education.
- Demonstrate teaching proficiency and professional competencies throughout the field/clinical experiences and student teaching.
- Pass sections of the National Teachers Examination required by the Ohio Department of Education.

Pass/No-Credit Policy

Required courses in the elementary and secondary education certification programs may not be taken on a pass/no-credit basis.

Course Scheduling

The majority of courses in teacher education are offered during the day. Most courses are designed with a field component so that you have the opportunity to apply your knowledge and skills in a school setting throughout the program. Courses without a field experience component may be offered in the evening and summer.

Certification Program Curriculum

The requirements for a baccalaureate degree with elementary or secondary education certification vary according to the major, but in all cases, in addition to the major selected, all students seeking such certification must complete the courses listed below. Further details, specific to the various majors, are provided on the following pages. Additional information can be obtained from the appropriate department chairperson.

ELEMENTARY CERTIFICATION (Grades 1-8)

General Education Program (48 Hours)

Further information is listed on page 55 of the current university catalog or can be obtained from the Department of Teacher Education or from the appropriate department chairperson.

Professional Education Requirements (55 Hours)

Course No.	Course	Cr. Hrs.
EDUC 110	Teacher as Inquir. Professional 1: Strategies for Observation and Reflection	4
EDUC 210	Teacher as Inquir. Professional 2: Strategies for Action Research	4
EDUC 220	Social/Physical/Intellectual Growth and Development	3
EDUC 230	Instructional Media, Technology, and Computers	4
EDUC 240	Foundations and Competing Epistemologies 1	3

As a general rule, no 300 or 400 level education courses will be transferred.

EDUC 310	Teacher as Inquir. Professional 3: Measurement, Diagnosis, and Evaluation	5
----------	---	---

Professional Education Requirements (cont'd.)

Course No.	Course	Cr. Hrs.
EDUC 340	Foundations and Competing Epistemologies 2	3
EDUC 420	Interdisciplinary Teaching Methods 2: Science and Mathematics Education	7
EDUC 421	Interdisciplinary Teaching Methods 1: Literacy and Social Studies Education	7
EDUC 450	Directed Teach. and Seminar	15

Arts and Sciences Curriculum Content (37 Hours)

ARTP 201	Art in the Elem. Curriculum 1	3
ARTP 202	Art in the Elem. Curriculum 2	3
HPER 202	Personal and Comm. Health	4
HPER 270	Phys. Ed. for the Elem. Class.	4
MATH 140	Elem. Topics in Mathematics 1	5
MATH 141	Elem. Topics in Mathematics 2	5
MUSI 160	Fundamentals of Music	3
MUSI 161	Music for the Class. Teacher	3
PSYC 375	Educational Psychology	4
SPCH 103	Pub. Spk. and Hum. Com.	3

SECONDARY CERTIFICATION (Grades 7-12)

General Education Program (48 Hours)

Further information is listed on page 55 of the current university catalog or can be obtained from the Department of Teacher Education or from the appropriate department chairperson.

Professional Education Requirements (57 Hours)

Course No.	Course	Cr. Hrs.
EDUC 110	Teacher as Inquir. Professional 1: Strategies for Observation and Reflection	4
EDUC 210	Teacher as Inquir. Professional 2: Strategies for Action Research	4
EDUC 220	Social/Physical/Intellectu	4
EDUC 230	Instructional Media, Technology, and Computers	4
EDUC 240	Foundations and Competing Epistemologies 1	3
EDUC 265	Teaching Indiv. in a Pluralistic Society	4
EDUC 310	Teacher as Inquir. Professional 3: Measurement, Diagnosis, and Evaluation	5
EDUC 330	Communication Across the Curriculum	4
EDUC 340	Foundations and Competing Epistemologies 2	3
EDUC 410	General Methods for Secondary Education	4
EDUC 43X	Methods Course for Secondary Education In selected content area.	4
DUC 450	Directed Teaching and Seminar	15

Related Studies Requirements (11 Hours)

PSYC 312	Adolescent Psychology	4
PSYC 375	Educational Psychology	4
SPCH 103	Pub. Spk. and Hum. Com.	3

English/Humanities Major with Elementary Education Certification

Degree Requirements

General Education Program 48 Hours

Further information is listed on page 55 of the current catalog or can be obtained from the department chairperson's office.

English/Humanities Courses 56 Hours

See page 67 of the current catalog or obtain from department chairperson's office.

Arts and Sciences Requirements 37 Hours

See left-hand column, this page. NOTE: Students may doublecount 15 hours toward their English/humanities major.

Professional Education Require. 55 Hours

See previous page.

Total Hours Required 196 Hours

Natural Science Major with Mathematics Concentration and Elementary Education Certification

Students seeking a bachelor of science in natural science degree with a concentration in mathematics who wish to be certified in elementary education must also complete the coursework listed below. It is important to note that these requirements are not entirely in addition to the bachelor of science degree but rather meet certain electives. You are urged to work closely with your mathematics advisor and with an advisor from the elementary education program.

Degree Requirements

General Education Program 48 Hours

Further information is listed on page 55 of the current catalog or can be obtained from the mathematics department chairperson's office.

Concentration Area 1 32 Hours

See page 75 of current catalog or obtain from mathematics department chairperson's office.

Concentration Area 2 <i>See page 75 of current catalog or obtain from mathematics department chairperson's office.</i>	16 Hours
Concentration Area 3 <i>See page 75 of current catalog or obtain from mathematics department chairperson's office.</i>	8 Hours
Senior Project in Mathematics MATH 496 and 497	4 Hours
Computer Science Elective <i>To be selected in consultation with department advisor.</i>	4 Hours
Arts and Sciences Requirements <i>See page 95 of the current catalog.</i>	37 Hours
Professional Education Require. <i>See page 94 of the current catalog.</i>	55 Hours
Total Hours Required	204 Hours

Natural Science Major in Biology or Chemistry with Elementary Education Certification

Students seeking a bachelor of science in natural science who wish to be certified in elementary education must complete the requirements which follow. It is important to note that these requirements are not entirely in addition to the bachelor of science degree but rather meet certain electives, such as the mathematics requirement, humanities/social science electives, and general electives. You will have some additional hours to meet all of the requirements. You are urged to discuss the elementary education option with your primary advisor in the Department of Natural Sciences and your advisor from the elementary education program.

Degree Requirements

General Education Program (48 Hours) <i>The General Education Program is composed of 48 credit hours of which 12 hours may be satisfied by the following science and mathematics requirements. Further information is listed on page 55 of the current catalog or can be obtained from the dean's office.</i>	36 Hours
Concentration Area 1 <i>See page 81 of current catalog or obtain from natural science department chairperson's office.</i>	36 Hours
Concentration Area 2 <i>See page 81 of current catalog or obtain from natural science department chairperson's office.</i>	16 Hours

Concentration Area 3 <i>See page 81 of current catalog or obtain from natural science department chairperson's office.</i>	8 Hours
NTSC 110S	4 Hours
Computer Science Elective	4 Hours
Arts and Sciences Requirements <i>See page 95 of current catalog.</i>	37 Hours
Professional Education Require. <i>See page 94 of current catalog.</i>	55 Hours
Total Hours Required	196 Hours

Social Science Major with Elementary Education Certification

Students majoring in social science who wish to complete requirements toward certification in elementary education may choose a special program which was designed to meet their needs. In this curriculum, social science majors take courses which cover subject matter traditionally taught as social studies in the elementary school. In addition to the teacher education requirements, the social science department requires a minimum grade of "C" in each required social science course in order to graduate. If you choose to pursue elementary education certification, you are urged to work closely with your social science advisor and with an advisor from the elementary education program.

Degree Requirements

General Education Program <i>Further information is listed on page 55 of current catalog or can be obtained from the department chairperson's office.</i>	48 Hours
Social Science Requirements <i>See page 88 of current catalog or obtain from department chairperson's office.</i>	60 Hours
Arts and Sciences Requirements <i>See page 95 of current catalog.</i>	37 Hours
Professional Education Requirements <i>See page 94 of current catalog.</i>	55 Hours
Total Hours Required	200 Hours

Mathematical Sciences Major with Secondary Education Certification

Degree Requirements

General Education Program	48 Hours
<i>Further information is listed on page 55 of the current catalog or can be obtained from the mathematics department chairperson's office.</i>	
Mathematics Requirements	61 Hours
<i>See page 74 of current catalog or obtain from mathematics department chairperson's office.</i>	
Professional Education Requirement	57 Hours
<i>See page 74 of current catalog or obtain from mathematics department chairperson's office.</i>	
Related Studies Requirement	32 Hours
<i>See page 74 of current catalog or obtain from mathematics department chairperson's office.</i>	
Total Hours Required	198 Hours

Natural Science Major with Mathematics Concentration and Secondary Education Certification

Degree Requirements

General Education Program	48 Hours
<i>Further information is listed on page 55 of the current catalog or can be obtained from the mathematics department chairperson's office.</i>	
Mathematics Requirements	61 Hours
<i>See page 74 of current catalog or obtain from mathematics department chairperson's office.</i>	
Professional Education Require.	57 Hours
<i>See page 74 of current catalog or obtain from mathematics department chairperson's office.</i>	
Related Studies Requirements	52 Hours
<i>See page 74 of current catalog or obtain from mathematics department chairperson's office.</i>	
Total Hours Required	218 Hours

Fine Arts Major with Visual Arts Certification (Grades K-12)

Degree Requirements

General Education Program	48 Hours
<i>Further information is listed on page 55 of the current catalog or can be obtained from the dean's office.</i>	
Visual Arts Content	95 Hours
Professional Education Requirement	61 Hours
Related Studies Requirement	11 Hours
Total Hours Required	215 Hours

Visual Arts Content (95 Hours)

DEGREE IN CERAMICS, DRAWING, OR PAINTING WITH K-12 EDUCATION CERTIFICATION

Art Core Requirements	44 Hours
<i>See page 68 of current catalog.</i>	
Art Specialization	40 Hours
<i>See page 68 of current catalog.</i>	
Art Studio Electives	11 Hours
<i>Chosen from courses outside art specialization.</i>	

OR

DEGREE IN STUDIO ART WITH K-12 EDUCATION CERTIFICATION

Art Core Requirements	44 Hours
<i>See page 68 of current catalog.</i>	
Studio Emphasis	32 Hours
<i>Choose either ceramics, drawing, or painting.</i>	
<i>See page 68 of current catalog.</i>	
Art Studio Electives	19 Hours
<i>Chosen from courses outside studio emphasis.</i>	

Professional Education Requirements (61 Hours)

Course No.	Course	Cr. Hrs.
EDUC 110	Teacher as Inquir. Professional 1	4
EDUC 210	Teacher as Inquir. Professional 2	4
EDUC 220	Soc./Phys./Intell. Growth	3
EDUC 230	Instruct. Media, Tech., and Comp.	4
EDUC 240	Found. and Compet. Epistem. 1	3
EDUC 265	Teach. Individ. in a Pluralistic Soc.	4
EDUC 310	Teacher as Inquir. Professional 3	5
EDUC 330	Comm. Across the Curriculum	4
EDUC 340	Found. and Compet. Epistem. 2	3
EDUC 431	Studio Methods for Elem. Ed.	6
	Cross-listed as ARTS 401	
EDUC 432	Studio Methods for Second. Ed.	6
	Cross-listed as ARTS 402	
EDUC 450	Directed Teaching and Seminar	15
	Cross-listed as ARTS 450	

Related Studies Requirement (11 Hours)

Course No.	Course	Cr. Hrs.
PSYC 312	Adolescent Psychology	4
PSYC 375	Educational Psychology	4
SPCH 103	Public Speaking	3

Reading Education Program

The reading education program provides a series of specially designed courses and field experiences leading to a reading endorsement (K-12) which can be added to the elementary or secondary certificate. This program is designed for both preservice students and in-service teachers.

Reading Endorsement Requirements

Course No.	Course	Cr. Hrs.
EDUC 312	Literacy Foundations <i>OR</i>	4
EDUC 320	Int. Tch. Meth: Lit. & Soc. St.	4
EDUC 321	Adv. Developmental Reading	4
EDUC 322	Writing for Elem./Sec. Ed.	4
EDUC 323	Adolescent Literature	4
EDUC 324	Critical Rdnq. in Content Areas	4
ENGL 300	Children's Literature	4
ENGL 360	Intro. to Lang. and Ling.	4
ENGL 362	Patterns of English	4
Total Hours Required		32

Note: Students must take and pass the NTE Reading Education Specialty Area Exam.

Bachelor Degrees

The bachelor of science in sports studies offered by the Department of Teacher Education prepares you for a career in an employment area that addresses the health and physical fitness needs of people in our society. Our curriculum ranges from in-depth study of the levels of sports participation to injury prevention and treatment to sports management in general. The program also provides the real work situations, hands-on training, and strong theoretical base from which you can make a career decision.

Graduates of the sports studies program make sport and fitness opportunities available to all people. Through professional and personal

interactions, our graduates touch the lives of others, influencing their goals, their attitudes, and their values. The importance of preparing you for this responsibility is central to Shawnee State's sports studies program and a charge we take seriously.

Application for Admission to the Sports Studies Degree Programs

(Athletic Training/Sports Management)

You must apply for and receive acceptance into the sports studies degree programs before you are eligible to take 300 and 400 level courses.

Applications are available from the Department of Teacher Education, located in Massie Hall, room 213. Once completed, applications should be returned to the Department of Teacher Education for review by the admissions committee, which meets to review applications on an as-needed basis.

Students are evaluated according to the minimum admission requirements listed below.

- You must have an overall GPA of 2.0 or higher.
- All of the following courses must be completed with a grade of C or higher:

BIOL 101	HPER activity course
ENGL 111S	HPER 202
ENGL 112S	MATH 110S
ENGL 115S	SPCH 103
HPER activity courses	
- You must have satisfactorily completed at least one quarter of HPER 251 Clinical/Field Experiences in Athletic Training taken prior to application.

Bachelor of Science in Sports Studies with a Concentration in Sports Management

This degree prepares you for employment in a corporate fitness center, health club, nautilus center, or sports organization/federation.

Students enrolled in the sports management concentration focus on business skills such as

financial management, marketing, and the legal questions associated with sports and exercise. They also examine the relationship of play, game sports, athletics, and fitness to our culture. This concentration's curriculum provides a foundation of sports management philosophy, principles, and objectives. Field experiences are also a part of the program and provide practical experience in various sports settings.

Degree Requirements

General Education Program	48 Hours
<i>Further information is listed on page 55 of the current catalog or can be obtained from the Department of Teacher Education.</i>	
Sports Studies Core	56 Hours
Activity Classes	12 Hours
Sports Management Concentration	73 Hours
University Electives	9 Hours
Total Hours Required	198 Hours

Sports Studies Core (56 Hours)

Course No.	Course	Cr. Hrs.
BIOL 101	Introduction to Biology	3
BIOL 310	Principles of Anatomy	5
BIOL 311	Kinesiology	4
HPER 202	Pers. and Comm. Health	4
HPER 203	Human Nutrition	4
HPER 220	Foundations of Athletic Training	3
HPER 227	First Aid	4
HPER 228	Law and Liability of Sports	4
HPER 261	Found. of Physical Exercise	2
HPER 352	Sports for the Disabled	3
HPER 360	Drugs/Substance Abuse	4
HPER 385	Psychology of Sports	3
HPER 386	Sociology of Sports	3
HPER 420	Physiology of Exercise	4
HPER 450	Org./Adm. of Sports Prog./Ath.	3
SPCH 103	Pub. Spk. and Hum. Com.	3

Activity Classes (12 Hours)

Students take four team sports, four individual sports, and four lifetime/leisure activity classes.

Team:	HPER 111	Basketball
	HPER 117	Volleyball
	HPER 124	Softball
	HPER 125	Soccer
Individual:	HPER 115	Bowling
	HPER 116	Gymnastics
	HPER 120	Golf
	HPER 130	Beginning Racquetball
	HPER 140	Beginning Tennis
	HPER 150	Swimming
	HPER 154	Life Guard Training
	HPER 160	Aerobic Dance
	HPER 187	Conditioning & Weight Trng.
Lifetime/ Leisure:	HPER 100	Dance: Concert and Recreation
	HPER 162	Yoga

HPER 170	Karate
HPER 172	Women's Self Defense
HPER 180	Jogging
HPER 182	Orienteering
HPER 185	Backpacking
HPER 186	Cycling

Sports Management Concentration (73 Hours)

BUAC 201	Financial Accounting	4
BUAC 203	Managerial Accounting	4
BUAI 101	Intro. to Auto. Info. Syst. OR	4
BUIS 101	Intro. to Computer Info. Syst.	4
BUFI 201	Principles of Finance	4
BUMG 310	Management Principles	4
BUMG 330	Organizational Communication	4
BUMK 310	Marketing Principles	4
BUSL 270	Legal Environment of Business	4
ECON 101	Macroeconomics	4
ECON 102	Microeconomics	4
HPER 201	Intro. to Sports Management	3
HPER 366	Aquatic Management	4
HPER 368	Introduction to Sport Law	4
HPER 390	Sports & Fitness Mgt. 1	4
HPER 392	Sports & Fitness Mgt. 2	4
HPER 407	Practicum 1 1 hr. seminar, 10 hrs. in field	4
HPER 499	Practicum 2 1 hr. seminar, 20 hrs. in field	6
SPCH 105	Intro. to Mass Communication	4

Bachelor of Science in Sports Studies with a Concentration in Athletic Training

Graduates of our athletic training program are able to implement prevention-of-injury programs and provide immediate treatment and rehabilitation procedures for injured athletes. They have a thorough knowledge of anatomy, psychology, hygiene, kinesiology, nutrition, taping, conditioning, prevention of injury methodology, protective equipment, first aid, and emergency care.

Our graduates also possess the human relations and communication skills necessary to work well with team physicians, coaches, administrators, and athletes.

The athletic training program uses practical education and a work experience approach to gaining the knowledge and skills needed to fulfill certification requirements through the National Athletic Trainer Association (NATA).

Special Note: Students are not automatically certified after the completion of the athletic training program. You must take and pass the National Athletic Trainers Association

Certification Examination. Before applying to take the examination, you must meet all criteria established by NATABOC, Inc. Contact the coordinator of the program for more information.

Degree Requirements

General Education Program	48 Hours
<i>Further information is listed on page 55 of the current catalog or can be obtained from the Department of Teacher Education.</i>	
Sports Studies Core	56 Hours
<i>See previous page.</i>	
Activity Classes	12 Hours
<i>See previous page.</i>	
Athletic Training Concentration	66 Hours
University Electives	16 Hours
Total Hours Required	198 Hours

Athletic Training Concentration (66 Hours)

Course No.	Course	Cr. Hrs.
BIOL 151	Principles of Biology	4
BIOL 315	Histology	5
HPER 222	Athletic Training Laboratory	2
HPER 251	Clin./Field Exper. in Ath. Trng. <i>Clinical and field experience in athletic training is required each quarter, up to a maximum of 36 credit hours within the total degree credit hour requirement.</i>	
HPER 320	Prevention and Assessment of Upper Extremity Injuries	3
HPER 322	Prevention and Assessment of Lower Extremity Injuries	4
HPER 325	Rehabilitation of Athletic Injury	3
HPER 326	Therapeutic Modalities	3
HPER 422	Prevention and Assessment of Non-Orthopedic Injuries	4
HPER 495	Spec. Top. in Athletic Training	2

New Programs

Faculty are developing a bachelor of science in education degree with majors in early childhood and middle childhood. These programs may be available by fall 1997. Please contact your advisor or the chairperson of the Department of Teacher Education for further information.

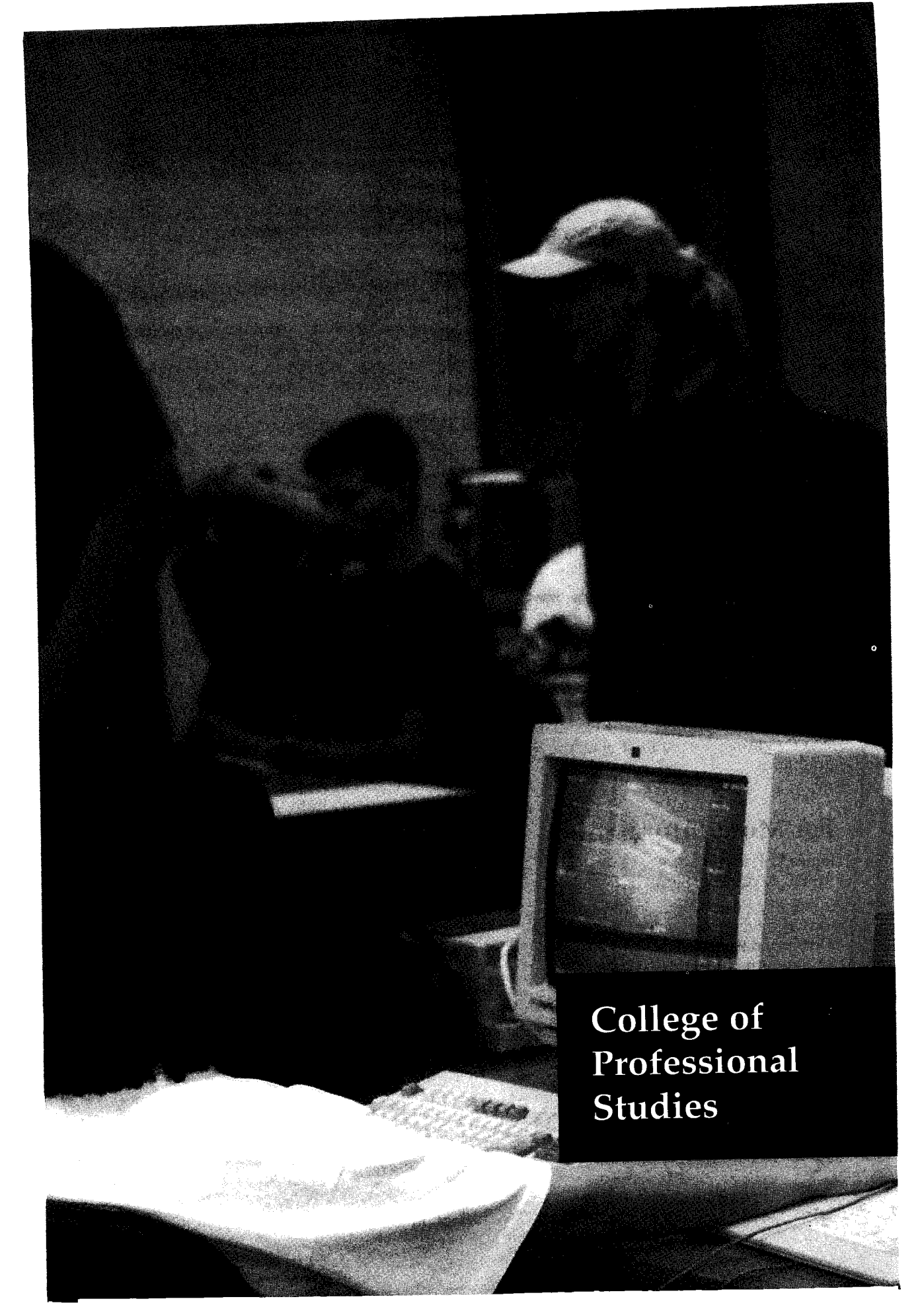

**College of
Professional
Studies**

College of Professional Studies

The mission of the College of Professional Studies is to prepare you for a meaningful career in business, engineering technologies, or health sciences. We are also committed to providing the practical and theoretical background that enables your success in advanced educational programs.

Courses taught in professional studies combine hands-on learning experiences, based on guided professional practice. Many courses are conducted in on-campus laboratories that simulate the career or industrial settings in which you will work after graduation. Others, especially in the health sciences, are taught in off-campus, clinical settings, where you experience interactions with clients first hand.

Students in professional studies also take courses offered by the College of Arts and Sciences. Many of these are career oriented, while some—especially in the General Education Program—are required of all university graduates.

For More Information

James R. Kadel, M.B.A., D.D.S., Dean
Ann C. McCarthy, Secretary

College of Professional Studies
Shawnee State University
940 Second Street
Portsmouth, Ohio 45662-4344

Phone: (614) 355-2270

Fax: [614] 355-2354

E-mail: amccarthy@shawnee.edu

Degrees Offered

Bachelor of Science

- Business Administration
- Business Administration, Health Management
- Business Administration, Legal Assisting (2+2)
- Business Administration, Management Information Systems
- Business Administration, Management Information Systems (2+2)
- Computer Engineering Technology
- Environmental Engineering Technology
- Medical Laboratory Science
- Occupational Therapy
- Plastics Engineering Technology

Associate of Applied Business

- Accounting Technology
- Business Information Systems
- Business Management Technology
- Legal Assisting Technology
- Office Administration Technology

Associate of Applied Science

- Associate Degree Nursing
- Computer Aided Drafting and Design
- Dental Hygiene
- Electromechanical Engineering Technology
- Emergency Medical Technology
- Instrumentation and Control Engineering Technology
- Medical Laboratory Technology
- Occupational Therapy Assistant
- Physical Therapist Assistant
- Plastics Engineering Technology
- Radiologic (X-ray) Technology
- Respiratory Therapy

Associate of Individualized Studies

See page 103 of the current catalog for description.

Certificates

- Computer Aided Drafting and Design
- Computer Technology
- Plastics Engineering Technology

Reputation for Excellence

Employers of our graduates consistently give high marks and excellent reviews to Shawnee State's professional studies programs, and many of our students are now successfully pursuing

graduate level work or have entered professional schools. Our students' performances on national and licensure exams are excellent; well above national averages. The College of Professional Studies jealously protects and continues to enhance this reputation for excellence.

Faculty

Faculty in professional studies are experienced and academically credentialed or certified by appropriate professional associations in their career fields. Moreover, our faculty are committed to your success in the college classroom and in your career beyond Shawnee State University.

Commitment to the Future

In addition to the degree programs listed on the previous page, the College of Professional Studies is currently seeking approval for other academic programs that address the educational needs of students and the employment needs of business, industry, and health care. Just as we survey employers to determine employment needs for the future, we also ask you to inform us of your educational and occupational goals so that we can become an active partner in the pursuit of those goals.

If the College of Professional Studies does not currently offer a degree that meets your needs, you may design, with the help of your academic advisor, an associate of individualized studies degree which includes two or more subject areas of interest to you.

We are proud of our graduates' success. Your participation and ideas contribute to our tradition of excellence.

Associate of Individualized Studies Degree

The associate of individualized studies degree (AIS) at Shawnee State University allows you to formulate your own individualized program of study based upon specific criteria. The goal of this degree is to permit the student, under the guidance of faculty advisors, to combine selected courses in academic and/or technical areas that may not meet the degree requirements for Shawnee State's associate of arts, associate of science, associate of applied

science, or associate of applied business degrees.

The following conditions must be met for completion of the degree: 1) a total of 90 credit hours of 100-level or above coursework with a minimum grade point average of 2.00; 2) a minimum of two areas of concentration with at least 20 credit hours in each; 3) a set of general education requirements based upon specific criteria; and 4) completion of a set of required hours of credit after admission to the program.

For specific details and application forms for the program, contact the dean's office in the College of Arts and Sciences or the dean's office in the College of Professional Studies.

Tutoring Assistance

The Department of Educational Needs Services (DENS) funds tutorial support for all students enrolled in associate degree (2-year) or certificate programs. If you need the help that tutoring provides, please register for these services in the Learning Center.



**Business
Administration**

Business

The Department of Business Administration prepares Shawnee State students for productive and satisfying professional careers in business. The Department seeks to develop in students a continuing intellectual curiosity, an awareness of individual and cultural diversity, and a high degree of professional competence. The Department encourages an integrated general education in the arts and sciences, provides a body of knowledge common to all areas of business, and provides a systematic body of specialized knowledge and skills applicable to specific business disciplines.

To meet the diverse needs of students and businesses, the Department offers programs at the associate level, stressing applied entry-level skills, and at the baccalaureate level, stressing the broader theoretical concepts and leadership skills applicable to more complex organizational problems.

For More Information

Roy B. Payne, M.B.A., Chairperson

Judith A. Nolfi, Secretary

Department of Business Administration
Shawnee State University

940 Second Street

Portsmouth, Ohio 45662-4344

Phone: (614) 355-2215

Fax: [614] 355-2663

E-mail: jnolfi@shawnee.edu

Degrees in Business

Bachelor of Science

Business Administration, General
Business Administration, Health Management
Business Administration, Legal Assisting (2+2)
Business Administration, Management
Information Systems
Business Administration, Management
Information Systems (2+2)

Associate of Applied Business

Accounting, Professional
Accounting, Management
Business Information Systems
Business Management, General

Associate of Applied Business (cont'd.)

Business Management, Focused
Legal Assisting
Office Administration Technology

Associate of Individualized Studies

See page 103 of the current catalog for description.

Bachelor Degrees

Special Notes for all Bachelor Degrees in Business Administration

Please read carefully. Consult your advisor if you do not fully understand.

- **Ethics Requirement, General Education Program** If you take BUMG 331 to meet your ethics requirement in the General Education Program, it cannot be counted as one of the 16 hours of upper division business electives.
- **Quantitative Reasoning Requirement, General Education Program** If you select MATH 150 or MATH 170 to fulfill your quantitative reasoning requirement in the General Education Program, you must meet the minimum degree requirement of 188 total credit hours.
- **Nonbusiness Electives** Two hours of nonbusiness courses may be in physical education (HPER).
- **Mathematics/English Sequence** Placement in beginning English and mathematics courses is determined by the mathematics and English placement tests. The minimum mathematics course in the business core is MATH 170. Any nondevelopmental mathematics courses (101 or higher) taken to meet the prerequisite for MATH 170 may be credited as nonbusiness electives toward the BSBA degree.
- **Transfer Credits** A maximum of 52 hours may be accepted as transfer credit to fulfill the credit hours required in the business core. Sixteen hours of upper division elective courses required for the general business concentration must be completed at Shawnee State University.
- **Special Topics in Business Courses (299, 399, and 499)** A formal review and a subsequent

written approval by the business department review committee is mandatory before credit is given for any special topics course. This review committee is made up of one member from each of the instructional areas, and this approval applies to all students. You can accumulate a total of 12 credit hours in the business department using special topics courses. These courses apply for credit toward electives only and not toward required courses or the 16 hours of upper division business electives. Faculty members do not have to teach a special topics course; it is the faculty member's option.

- **Upper-Level/Lower-Level Course Credit**
Any student having earned credit for an upper-level course cannot subsequently earn credit for a lower sequence course and apply it toward graduation. Example: If you earned credit for BUMG 310, you could not later take the lower-level courses and apply their credits toward graduation. This notice applies, but is not limited to BUFI 245 and 250, BUMG 101, 210, and 235.

Bachelor of Science in Business Administration with a Concentration in General Business

The four-year program in general business is designed to provide a broad understanding of business by focusing on all aspects of its dynamics. A broad-based general education precedes an extensive education in general business. Successfully completing this degree program gives you the necessary tools to enter a career in business or to pursue graduate study.

The general business program has both a core of business courses and nonbusiness courses. You choose, after consulting with your advisor, at least one upper division course in four of the prescribed elective areas: accounting, automated information systems, finance, management, and marketing. This gives you some flexibility in designing a program which meets your career goals.

Degree Requirements

General Education Program	48 Hours
<i>Further information is listed on page 55 of the current catalog or can be obtained from the business administration department chairperson's office.</i>	
Business Core Courses	72 Hours
Upper Division Electives	16 Hours
Other Business Electives	20 Hours
Nonbusiness Electives	24 Hours
Business or Nonbusiness Electives	8 Hours
Total Hours Required	188 Hours

Business Core Courses (72 Hours)

Course No.	Course	Cr. Hrs.
BUAC 201	Financial Accounting Principles	4
BUAC 203	Managerial Accounting	4
BUAI 101	Intro. to Auto. Info. Systems	4
BUAI 103	Computer Applications	4
BUFI 345	Managerial Finance	4
BULW 270	Legal Environment of Business	4
BUMG 310	Management Principles	4
BUMG 330	Organizational Communication	4
BUMG 340	International Business	4
BUMG 355	Quantitative Methods in Bus.	4
BUMG 385	Production/Operations Mgt.	4
BUMG 410	Business Simulation OR	4
MATH 190	Brief Calculus (<i>if grad. study is planned</i>)	4
BUMG 485	Business Policy/Strategy	4
BUMK 310	Marketing Principles	4
ECON 101	Principles of Macroeconomics	4
ECON 102	Principles of Microeconomics	4
MATH 150	Principles of Statistics	4
MATH 170	Applied Finite Mathematics	4

Upper Division Electives (16 Hours)

Choose one 300-400 upper level course from any four of the following five areas for a total of 16 credit hours:

- BUAC Accounting
- BUAI Automated Information Systems
- BUFI Finance
- BUMG Management
- BUMK Marketing

Bachelor of Science in Business Administration with a Concentration in Health Management

The bachelor of science in business administration with a concentration in health management helps prepare you for a career in the health care industry. Graduates of the program find employment as health service

managers with various organizations, including hospitals, clinics, health maintenance organizations, and nursing homes. In addition, the program provides excellent preparation for graduate study in business or health administration.

Students electing to follow the **extended care track** are eligible to take the State and Federal Nursing Home Administrators' Licensing Exam upon graduation.

Extended care track students are required to complete a total of 800 on-site hours in a nursing home using a combination of BUHE 385, 451, and/or 452. All on-site hours must be approved by the coordinator.

Class Scheduling

Health management courses are offered late in the afternoon and in the evening to accommodate the working professional.

Degree Requirements

General Education Program

Further information is listed on page 55 of the current catalog or can be obtained from the department chairperson's office.

Business Core Courses

See concentration in general business

Health Management Concentration

Electives

Total Hours Required

48 Hours

72 Hours

66 Hours

4 Hours

190 Hours

Health Management Concentration (66 Hours)

Course No.	Course	Cr. Hrs.
BUAC 410	Health Care Acct./Admin.	4
BUHE 202	Personal and Community Health	4
BUHE 300	Medical Term. for Health Mgrs.	4
BUHE 310	Orien. to Health Care Mgt.	4
BUHE 312	Health Care Personnel Mgt.	4
BUHE 314	Community Health Programs	4
BUHE 385	Practicum 1-4	4
	<i>May be repeated up to 5 hours</i>	
BUHE 410	Patient Care Issues in Long-Term Health Care Facilities OR	4
BUHE 415	Admin. in Acute Care Facilities	4
BUHE 411	Admin. in Extended Health Care Facilities OR	4
BUHE 416	Mgt. Issues in Acute Care Fac.	4
BUHE 420	Problems and Policies in Health Care Management	4
BUHE 430	Health Care Finance and Reimbursement	4

BUHE 451 ¹	Internship in Extended Health Care Facilities OR	6
BUHE 452 ¹	Internship in Acute Health Care Facilities	4
ETCO 210	Occup. Safety & Health Mgt.	4
GEOG 310	Medical Geography: Geog. of Life or Death	4
PSYC 340	Psychology of the Adult	4
SOCI 405	Death and Dying	4

Bachelor of Science in Business Administration with a Concentration in Legal Assisting

2+2 for students who complete the Legal Assisting Technology Program

This program is designed for students who have completed the associate degree in legal assisting at Shawnee State and who wish to attend law school or to pursue any career—either traditional or nontraditional—which requires paralegal skills or a paralegal background. Some examples of career opportunities for graduates of our program are internal revenue officer, clerk of courts, veterans claims examiner, and computer litigation support.

All required courses in the legal assisting program (99 hours) count toward the baccalaureate requirements. After transferring the legal assisting credits, the bachelor of science student needs to complete 32 hours of the General Education Program requirements and 60 hours of the Business Core.

Degree Requirements

General Education Program

(32 hours needed after transfer of credits from associate degree program.) Further information is listed on page 55 of the current catalog or can be obtained from the business department chairperson's office.

48 Hours

Business Core Courses

(60 hours needed after transfer of credits from associate degree program.)

76 Hours

Legal Assisting Curriculum

67 Hours

Total Hours Required

191 Hours

(92 hours needed after transfer of credits from associate degree program)

¹ All coursework complete and permission.

Business Core Courses (76 Hours)

"T" indicates that course is transferable from associate degree program.

Course No.	Course	Cr. Hrs.
BUAC 101 ¹	Accounting 1	T
BUAC 102 ¹	Accounting 2	T
BUAC 103 ¹	Accounting 3	4
BUAI 101	Intro. to Auto. Info. Systems (BULA 264 = T)	T
BUAI 103	Computer Applications	4
BUFI 345	Managerial Finance	4
BULW 270	Legal Environment of Business (BULW 250 = T)	T
BUMG 310	Management Principles	4
BUMG 330	Organizational Communication	4
BUMG 340	International Business	4
BUMG 355	Quantitative Methods in Bus.	4
BUMG 385	Production/Operations Mgt.	4
BUMG 410	Business Simulation OR	4
MATH 190	Brief Calculus (if grad. study planned)	4
BUMG 485	Business Policy/Strategy	4
BUMK 310	Marketing Principles	4
ECON 101	Principles of Macroeconomics	4
ECON 102	Principles of Microeconomics	4
MATH 150	Principles of Statistics	4
MATH 170	Applied Finite Mathematics	4

Legal Assisting Curriculum (67 Hours)

BULA 101	Introduction to Legal Assisting	T
BULA 212	Real Estate Law for Legal Asst.	T
BULA 251	Legal Research and Writing 1	T
BULA 252	Legal Research and Writing 2	T
BULA 261	Tort Law	T
BULA 262	Introduction to Civil Litigation	T
BULA 263	Intro. to Contracts and Restitu.	T
BULA 265	Family Law	T
BULA 266	Wills, Trusts, and Estates	T
BULA 267	Legal Assisting Practicum	T
BULA 269	Criminal Law/Criminal Procecd.	T
BULA 270	Evidence	T
BULW 260	Business Law 2	T
ENGL 121	Technical Writing	T
GOVT 250	Intro. to Political Science	T
MATH	Mathematics Placement (101 or above)	T
PSYC 101	Introduction to Psychology	T

Bachelor of Science in Business Administration with a Concentration in Management Information Systems

This program is designed for students entering Shawnee State for the first time, as well as for students who have completed the

associate degree in business information systems. Most courses in the BIS program count toward the baccalaureate degree (see the 2+2 program).

Degree Requirements

General Education Program	48 Hours
<i>Further information is listed on page 55 of the current catalog or can be obtained from the business department chairperson's office.</i>	
Business Core Courses	72 Hours
<i>See concentration in general business.</i>	
MIS Concentration	48 Hours
Business/Nonbusiness Electives	20 Hours
Total Hours Required	188 Hours

MIS Concentration (48 Hours)

Course No.	Course	Cr. Hrs.
BUAI 201	Info. Sys. Theory & Practice	4
BUAI 301	Info. Tech. Hrdwr. & Sftwr.	4
BUAI 310	Database Management	4
BUAI 320	Systems Analysis & Design	4
BUAI 330	Data & Object Struc. in Prog.	4
BUAI 421	Design & Implem. w/DBMS	4
BUAI 422	IS Application w/Prog. Environ.	4
BUAI 430	Info. Sys. Deployment & Mgt.	4
BUIS 105	COBOL Programming 1	4
BUIS 106	COBOL Programming 2	4
BUIS 201	C Language	4
BUIS 205	Business Data Sys. & Comm.	4

Bachelor of Science in Business Administration with a Concentration in Management Information Systems

2+2 for students who complete the Business Information Systems Program

This program is designed for students who have completed the associate degree in business information systems. Most courses in the BIS program count toward the baccalaureate degree.

¹ BUAC 101, 102, and 103 are equivalent to BUAC 201 and 203

Degree Requirements

General Education Program
 (32 hours needed after transfer of credits from associate degree program.) Further information is listed on page 55 of the current catalog or can be obtained from the business department chairperson's office.

Business Core Courses
 (40 hours needed after transfer of credits from associate degree program.)

MIS Concentration
 (24 hours needed after transfer of credits from associate degree program.)

Business/Nonbusiness Electives

Total Hours Required

48 Hours

72 Hours

48 Hours

20 Hours

188 Hours

Business Core Courses (72 Hours)

"T" indicates that course is transferable from associate degree program.

Course No.	Course	Cr. Hrs.
BUAC 101 ¹	Accounting 1	T
BUAC 102 ¹	Accounting 2	T
BUAC 103 ¹	Accounting 3	T
BUAI 101	Intro. to Auto. Info. Systems	4
BUAI 103	Computer Applications	4
BUFI 345	Managerial Finance	4
BUIS 101	Intro. to Comp. Info. Systems	T
BUIS 204	Microcomputer Applications	T
BULW 250	Business Law 1	T
BULW 270	Legal Environment of Business	4
BUMG 310	Management Principles	4
BUMG 330	Organizational Communication	4
BUMG 340	International Business	4
BUMG 355	Quantitative Methods in Bus.	4
BUMG 385	Production/Operations Mgt.	4
BUMG 410	Business Simulation OR	4
MATH 190	Brief Calculus (if grad. study planned)	4
BUMG 485	Business Policy/Strategy	4
BUMK 310	Marketing Principles	4
ECON 101	Principles of Macroeconomics	4
ECON 102	Principles of Microeconomics	4
MATH 150	Principles of Statistics	4
MATH 170	Applied Finite Mathematics	4

MIS Concentration (48 Hours)

BUAI 201	Info. Sys. Theory & Practice	4
BUAI 301	Info. Tech. Hrdwr. & Sftwr.	4
BUAI 310 ²	Database Management	T
BUAI 320 ²	Systems Analysis & Design	T
BUAI 330	Data & Object Struc. in Prog.	4
BUAI 421	Design & Implem. w/DBMS	4
BUAI 422	IS Application w/Prog. Environ.	4
BUAI 430	Info. Sys. Deployment & Mgt.	4
BUIS 105	COBOL Programming 1	T
BUIS 106	COBOL Programming 2	T
BUIS 201	C Language	T
BUIS 205 ²	Business Data Sys. & Comm.	T

¹BUAC 101, 102, and 103 are equivalent to BUAC 201 and 203.
²Taken as elective in associate degree program.

Associate Degrees

Associate Degree in Applied Business

Our associate degrees in applied business have two goals: to prepare you for the job market and to give you the necessary foundation to advance, if you choose, to the bachelor of science degree program.

There are five areas of study from which you may choose.

- Accounting Technology
- Business Information Systems
- Business Management Technology
- Legal Assisting Technology
- Office Administration Technology

Accounting Technology

The field of accounting offers many career opportunities in both the private and public sector.

■ Management (Industrial) Accounting

The management accountant is trained to determine the financial consequences of management decisions. The reports and analyses of the management accountant are essential ingredients of most management decisions about finance, investments, and pricing policies. More than anyone else on the management team, the management accountant participates in virtually every phase of the business problem solving and decision making process. Because of the accountant's role in this process, he or she has many times advanced to a top management position within the company.

■ Governmental Accounting

All organizations need accounting information, and government and other nonprofit organizations are no exception. The federal government hires accountants in most of its agencies. Three prominent agencies are the Internal Revenue Service, the General Accounting Office, and the Defense Contract Audit Agency. State and local government units hire accountants in their tax divisions and in general accounting functions.

Schools and hospitals are major users of accounting services. Many opportunities exist for those interested in governmental accounting.

■ **Public Accounting and the CPA** For the protection of the public, the CPA is expected to possess certain professional qualifications. The Uniform CPA Examination measures the technical competency, the exercise of good judgement, and the understanding of professional responsibility of each man or woman who chooses this career in accounting. The public accountant is a true independent professional person with the stature of a doctor or lawyer. In public accounting many opportunities exist for professional growth, whether you practice as a sole practitioner or as part of a larger firm.

Please see the note on page 116 regarding a new bachelor of science with a concentration in accounting.

Class Scheduling

Shawnee State offers its accounting courses in both day and evening sections.

Sample Schedule

Students planning to pursue a baccalaureate degree should contact an accounting advisor for course substitutions.

Course No.	Course	Cr. Hrs.
FIRST QUARTER		
BUAC 101	Accounting 1	4
BUIS 101	Intro. to Comp. Info. Syst. OR	4
BUAI 101	Intro. to Auto. Info. Systems	
BUMG 101	Introduction to Business	4
ENGL 111S	Discourse and Composition	4
	Total	16
SECOND QUARTER		
BUAC 102	Accounting 2	4
BUMG 210	Management Concepts	4
ECON 101	Principles of Macroeconomics	4
ENGL 112S	Composition and Research	4
MATH	<i>Eight hours total required, which must include MATH 125 or higher</i>	4
	Total	20
THIRD QUARTER		
BUAC 103	Accounting 3	4
BUAC 110	Payroll Records/Accounting	4

ECON 102	Principles of Microeconomics	4
ENGL 115S	Composition and Literature	4
MATH	<i>Eight hours total required, which must include MATH 125 or higher</i>	4
	Total	20

SECOND YEAR CURRICULUM: Accounting/Professional Emphasis

FOURTH QUARTER		
BUAC 221	Cost Accounting 1	4
BUAC 231	Intermediate Accounting 1	4
BUFI 245	Principles of Finance	4
BULW 250	Business Law 1	4
BUMG	Elective (<i>must be 200 level or above</i>)	4
	Total	20
FIFTH QUARTER		
BUAC 222	Cost Accounting 2	4
BUAC 232	Intermediate Accounting 2	4
BUAI/BUIS/ BUOA ¹	Elective	4
SOCI/PSYC	Elective	4
SPCH 103	Pub. Speak. and Human Com.	3
	Total	19
SIXTH QUARTER		
BUAC 233	Intermediate Accounting 3	4
BUAC	Elective	4
BUMG 242	Business Communications	4
SOCI/PSYC	Elective	4
	Total	16

SECOND YEAR CURRICULUM: Accounting/Management Emphasis

FOURTH QUARTER		
BUAC 221	Cost Accounting 1	4
BUAC 231	Intermediate Accounting 1	4
BULW 250	Business Law 1	4
BUFI 245	Principles of Finance	4
BUMG	Elective (<i>must be 200 level or above</i>)	4
	Total	20
FIFTH QUARTER		
BUAC 222	Cost Accounting 2	4
BUAI/BUIS/ BUOA ¹	Elective	4
BUMG	Elective (<i>must be 200 level or above</i>)	4
SOCI/PSYC	Elective	4
SPCH 103	Pub. Speak. and Hum. Com.	3
	Total	19
SIXTH QUARTER		
BUAC	Elective	4
BUAC 215	Tax Accounting	4
BUMG 242	Business Communications	4
SOCI/PSYC	Elective	4
	Total	16

¹ Choose from: BUAI 103, BUAI 310, BUAI 320, BUIS 204, BUOA 215, BUOA 217, BUOA 221, or BUOA 222

Business Management Technology with General or Focused Emphasis

Management is the ability and skill to develop a plan, to organize people and other resources, and to guide and motivate others to achieve some desired result. All organizations are trying to achieve some goal; therefore, all organizations need people with managerial knowledge and skills to help them accomplish their goals. For this reason, there are many diverse job opportunities available to people who possess management knowledge and skills.

Whether you're just entering the job market or returning to college to improve your job opportunities, the business management program includes courses that will help you gain the knowledge and skills you need to analyze an organization's problems and to develop, organize, communicate, and implement solutions to those problems. Much of this knowledge and many of these skills are universal—they apply to all kinds of organizations at many levels. When you complete the program you are equipped to begin your career in various entry-level supervisory, administrative, management trainee, or sales positions.

Flexibility distinguishes the business management program from other two-year associate degree programs. It offers you the opportunity to choose a broad based course of study or a more focused specialization in one of three management related disciplines.

Degree Requirements

Nonbusiness Courses	23 Hours
Business Courses	52 Hours
General or Focused Emphasis	24 Hours
Total Hours Required	99 Hours

Nonbusiness Courses (23 Hours)

Course No.	Course	Cr. Hrs.
ENGL 111S	Discourse and Composition	4
ENGL 112S	Composition and Research	4
ENGL 115S	Composition and Literature	4
MATH 125	Business Mathematics OR	4
MATH	(numbered higher than 125)	4
SOCI 110S	Found. of Social Science OR	4
SOCI 101	Introduction to Sociology	3
SPCH 103	Pub. Speak. and Hum. Com.	3

Business Courses (52 Hours)

BUAC 101	Accounting 1 AND	4
BUAC 102	Accounting 2 OR	4
BUAC 201	Financial Acct. Principles AND	
BUAC 203	Managerial Accounting	
BUAI 101	Intro. to Auto. Info. Sys. OR	4
BUIJ 101	Intro. to Comp. Info. Systems	4
BUFI 245	Principles of Finance	4
BULW 250	Business Law 1	4
BULW 260	Business Law 2	4
BUMG 210	Management Concepts	4
BUMG 242	Business Communications	4
BUMG 285	Enterprise Mgt. and Strategy	4
BUMK 210	Marketing Concepts	4
BUOA 215	Lotus 1, 2, 3 OR	4
BUIJ 204	Microcomputer Applications OR	
BUAI 103	Computer Applications (for those transferring into BSBA program)	
ECON 101	Principles of Macroeconomics	4
ECON 102	Principles of Microeconomics	4

General Emphasis (24 Hours)

In addition to the required business and nonbusiness courses shown above, the general emphasis requires you to take two courses in management, marketing, and finance for a total of 24 hours. This provides the kind of broad and flexible background that many of today's employers value in future employees. It's also a good choice for those who plan to manage the family business or for entrepreneurs who want to develop their own business.

If you choose a general emphasis, you will take two courses from each of the following three areas for a total of six courses:

Marketing (choose 2)

BUMK 235	Advertising
BUMK 220	Salesmanship
BUMK 225	Marketing Case Studies

Management (choose 2)

BUMG 225	Org. & Operation of Small Business
BUMG 235	Personnel Management
BUMG 240	Labor Relations

Finance (choose 2)

BUFI 205	Installment Credit
BUFI 240	Personal Finance
BUFI 250	Introduction to Investments

Focused Emphasis (24 Hours)

The focused emphasis allows you to achieve a degree of specialization by taking six courses for a total of 24 hours in one of three areas: management, marketing, or finance. This emphasis is a good choice if you have decided on a career or are currently employed in one of those areas.

If you choose a focused emphasis in marketing, management, or finance, you will take all of the courses shown below in your chosen emphasis.

Marketing

- BUMK 235 Advertising
- BUMK 220 Salesmanship
- BUMK 225 Marketing Case Studies
- BUMK 315 International Marketing
- BUMK 320 Sales Management
- BUMK 325 Marketing Research

Management

- BUMG 225 Org. & Operation of Small Business
- BUMG 235 Personnel Management
- BUMG 240 Labor Relations
- BUMG 310 Management Principles
- BUMG 331 Business Ethics
- BUMG 340 International Business

Finance

- BUFI 205 Installment Credit
- BUFI 240 Personal Finance
- BUFI 250 Introduction to Investments
- BUFI 301 Principles of Insurance
- BUFI 315 Financial Institutions
- BUFI 300 Level Finance Elective

Sample Schedule

Course No.	Course	Cr. Hrs.
FIRST QUARTER		
BUAC ¹	Accounting 101 or 201	4
BUMG 210	Management	4
ENGL 111S	Discourse and Composition	4
MATH	Elective	4
	Total	16
SECOND QUARTER		
BUAC ¹	Accounting 102 or 203	4
BUMK 210	Marketing Concepts	4
BUAI 101	Intro. to Auto. Info. Syst. OR	4
BUIS 101	Intro. to Computer Info. Syst.	4
ENGL 112S	Composition and Research	4
	Total	16
THIRD QUARTER		
BUAI 103	Computer Applications OR	4
BUOA 215	Lotus 1-2-3 OR	
BUIS 204	Microcomputer Applications	4
BUMG 242	Business Communications	4
ENGL 115S	Composition and Literature	4

SPCH 103	Pub. Speak. and Hum. Com.	3
	Emphasis Elective	4
	Total	19
FOURTH QUARTER		
BUFI 245	Principles of Finance	4
BULW 250	Business Law 1	4
ECON 101	Principles of Macroeconomics	4
	Emphasis Elective	4
	Total	16
FIFTH QUARTER		
BULW 260	Business Law 2	4
ECON 102	Principles of Microeconomics	4
	Emphasis Electives	8
	Total	16
SIXTH QUARTER		
BUMG 285	Enterprise Mgt. and Strategy	4
SOCI 110S	Found. of Social Science OR	4
SOCI 101	Introduction to Sociology	4
	Emphasis Electives	8
	Total	16

Business Information Systems

The business information systems associate degree program at Shawnee State University is designed to meet the manpower demand of industries, government, and educational institutions.

In addition to theoretical fundamentals, practical aspects of computer systems in business are emphasized. Hands-on opportunity is provided and encouraged.

Graduates of this program are fully prepared to enter employment as computer programmers, operators, or microcomputer specialists in computer installations or application departments. Graduates of this technology receive an associate degree in applied business and are eligible to enroll in the 2+2 program described on page 108 of this catalog. This program allows you to apply your associate degree courses towards a bachelors degree in business administration. For more details on the 2+2 option, or any business information systems degree, please schedule a meeting with an advisor in that field.

Class Scheduling

Most computer classes are offered in both the day and evening sections. See your advisor.

¹ Choose either the BUAC 101/102 or the BUAC 201/203 sequence. Accounting sequences cannot be mixed.

Sample Schedule

Course No.	Course	Class Hrs.	Lab Hrs.	Credit Hrs.
FIRST QUARTER				
BUAC 101	Accounting 1	3	2	4
BUIS 101	Intro. Comp. Info. Sys.	4	0	4
BUOA 108	Beg. Doc. Process.	4	0	4
ENGL 111S	Discourse and Comp.	4	0	4
MATH ¹	Math. Requirement	4	0	4
	Totals	19	2	20
SECOND QUARTER				
BUAC 102	Accounting 2	3	2	4
BUAI 103	Computer Applic. OR	4	0	4
BUIS 204	Microcomputer Applic.			
BUIS 103	Visual BASIC Language 1	4	0	4
ENGL 112S	Comp. and Research	4	0	4
	Totals	15	2	16
THIRD QUARTER				
BUAC 103	Accounting 3	3	2	4
BUIS 201	"C" Language	4	0	4
ENGL 115S	Comp. and Literature	4	0	4
MATH ¹	Mathematics Requirement	4	0	4
	Totals	15	2	16
FOURTH QUARTER				
BUIS 105	COBOL Programming 1	4	0	4
BUIS ²	Elective	3-4	0	3-4
BULW 250	Business Law 1	4	0	4
ENGL 121	Technical Writing	3	0	3
SOCI XXX	Social Science Elective	4	0	4
	Totals	18-19	0	18-19
FIFTH QUARTER				
BUMG 210	Management Concepts	4	0	4
BUIS 106	COBOL Programming 2	4	0	4
BUIS 203	Bus. Computer Projects	4	0	4
ECON 101	Prin. of Macroeconomics	4	0	4
	Totals	16	0	16
SIXTH QUARTER				
BUIS 208	RPG Language	4	0	4
BUIS ²	Electives (2)	7-8	0	7-8
MATH 150	Principles of Statistics	4	0	4
	Totals	15-16	0	15-16

Office Administration Technology

Various positions are available after completion of the office administration program. The graduate is qualified to fill a broad range of office positions which require technical skills. The program includes training in the preparation of medical and legal documents, equipping you for all positions in these specialized fields.

Word processing specialists are qualified to keyboard, revise, and store documents for immediate or future use. Graduates are trained in the various functions of the WordPerfect 6.1 for Windows word processing system. Students also have the opportunity to use Lotus 1-2-3 Release 5 for Windows, Access 2.0 for Windows, Power Point 4 for Windows, Word 6 for Windows, Excel 5 for Windows, and PageMaker 5.0 software.

Class Scheduling

Certain office administration courses are normally offered only in the day sections. See your advisor.

Suggested Electives

The following classes are suggested as electives to provide a wider training base to qualify the graduate for a variety of office positions: BUAI 310, BUMG 242, BUOA 230, and BUOA 231.

Previous Keyboard Training (Business Information Systems and Office Administration)

If you have previously received credit in a typing/keyboarding course, you may omit taking BUOA 108 Beginning Document Processing.

The sequence of classes for Office Administration students not taking BUOA 108 is BUOA 109, BUOA 110, and BUOA 230.

Sample Schedule

Course No.	Course	Class Hrs.	Lab Hrs.	Credit Hrs.
FIRST QUARTER				
BUMG 101	Introduction to Business	4	0	4
ENGL 111S	Discourse and Comp.	4	0	4
BUOA 108	Beg. Document Process. OR	4	0	4
BUOA 109	Intermed. Doc. Process.			
BUOA 111	SuperWrite 1	4	0	4
BUOA 130	Records Management	4	0	4
	Totals	20	0	20
SECOND QUARTER				
ENGL 112S	Comp. and Research	4	0	4
BUOA 109	Intermed. Doc. Process. OR	4	0	4
BUOA 110	Advanced Doc. Process			

¹ Student placement in mathematics courses depends on placement test results. All BUIS majors must take at least eight credit hours of mathematics at or above MATH 101.

² BUIS Electives: BUAI 310 Data Base Management, BUAI 320 Systems Analysis and Design, BUIS 104 Basic Language 2, BUIS 202 Computer Operations Management, BUIS 205 Business Data Systems and Communication, BUIS 206 FORTRAN 77, BUIS 207 Pascal Language, BUIS 299 Special Topics in Data Processing, BUOA 230 Desktop Publishing 1.

Course No.	Course	Class Hrs.	Lab Hrs.	Credit Hrs.
SECOND QUARTER (cont'd.)				
BUOA 112	SuperWrite 2	4	0	4
BUOA 221	Word Processing 1	4	0	4
	Totals	16	0	16
THIRD QUARTER				
BUFI 240	Personal Finance OR	4	0	4
MATH 125	Business Mathematics			
BUOA 110	Advanced Doc. Process. OR	4	0	4
BUOA 230	Desktop Publishing			
BUOA 222	Word Processing 2	4	0	4
ENGL 115S	Comp. and Literature	4	0	4
	Totals	16	0	16
FOURTH QUARTER				
BULW 250	Business Law 1	4	0	4
BUOA 214	Microcomputer Off. Prac.	4	0	4
BUOA 223	Word Processing 3	4	0	4
BUOA 241	Office Administration 1	4	0	4
	Totals	16	0	16
FIFTH QUARTER				
BUOA 215	Lotus 1-2-3	4	0	4
BUOA 242	Office Administration 2	4	0	4
BUOA 244	Med./Legal Office Admin.	4	0	4
SPCH 103	Pub. Spk. and Hum. Com.	3	0	3
	Totals	15	0	15
SIXTH QUARTER				
BUMG 235	Personnel Management	4	0	4
BUOA 217	Office Computer Applc.	4	0	4
PSYC 101	Introduction to Psychology	4	0	4
SOCI 101	Introduction to Sociology	4	0	4
	Totals	16	0	16

Legal Assisting Technology

Legal assistants perform many tasks under the supervision of attorneys. Their responsibilities may include:

- Legal and factual research
- Interviewing clients and witnesses
- Reviewing and organizing material for cases
- Drafting legal documents and forms
- Functioning as a member of a legal team

Jobs for the legal assistant vary in scope and nature from small to large law firms, financial institutions, corporations, law courts, insurance agencies, banks, department stores, credit departments, and health care facilities. It is one of the fastest growing areas of employment in the United States today.

Career Opportunities

A paralegal's job title may reflect the type of law practiced by their employer, for example, administrative law, banking, bankruptcy, or corporate paralegal. Paralegals are also employed in the areas of criminal, domestic relations, employee benefits, environmental, family,

health care, insurance, oil and gas, and worker's compensation law as well as in estate planning and litigation.

Positions in the federal government which may require a paralegal background include: clerk of courts, civil service retirement claims examiner, compliance inspector, contract representative, criminal investigator, customs inspector, customs patrol officer, dependents and estates claims examiner, equal opportunity assistant, general claims examiner, insurance examiner, internal revenue officer, legal clerk, mediator, railroad retirement claims examiner, securities compliance examiner, social insurance claims examiner, unemployment compensation claims examiner, veterans claims examiner, and worker's compensation claims examiner.

Nontraditional career positions which require either paralegal skills or a paralegal background, but may or may not utilize the terms "paralegal" or "legal assistant," include: administrative assistant, case manager coordinator, case manager, computer litigation support, executive assistant, human resources staff analyst, legal research aide, litigation manager, project coordinator, resource coordinator, and title clerk.

Goals of the Program

The legal assisting program has clearly established goals designed to meet the unique needs of our students, potential employers of our graduates, and the mission of Shawnee State University. Our goals are as follows: (1) to graduate ethically responsible legal assistants who work under the direction and supervision of attorneys and who are conscious of the prohibitions against the unauthorized practice of law; (2) to create and maintain a program responsive to the needs of its constituency; (3) to strive to qualify graduates who will contribute to the advancement of the profession, rather than to serve only the purposes of one institution or locality; and (4) to develop the student's sensitivity to emerging concepts regarding the role of the legal assistant in the effective delivery of legal services in both the private and public sectors of our society.

The legal assisting courses at Shawnee State are not theory courses, but rather practical "how to" courses taught by attorneys and judges who have specialized in the area in which they teach. The associate degree in legal assisting requires a minimum of 99 hours.

Class Scheduling

Because most of the legal assisting (BULA) courses are taught by attorneys and judges, these courses are most often offered in the evening sections.

Sample Schedule

Course No.	Course	Cr. Hrs.
FIRST QUARTER		
BULA 101	Introduction to Legal Assisting	4
BULW 250	Business Law 1	4
ENGL 111S	Discourse and Composition	4
MATH XXX	Placement	4
	Total	16
SECOND QUARTER		
BULA 251	Legal Research and Writing 1	4
BULW 260	Business Law 2	4
ENGL 112S	Composition and Research	4
SOCI 110S	Found. of Social Science OR	4
SOCI 101	Introduction to Sociology	4
	Total	16
THIRD QUARTER		
BULA 252	Legal Research and Writing 2	4
BULA 262	Introduction to Civil Litigation	4
GOVT 250	Intro. to Political Science	4
PSYC 101	Introduction to Psychology	4
	Total	16
FOURTH QUARTER		
BULA 261	Tort Law: Personal Injury Lit.	4
BULA 263	Intro. to Contracts & Restitution	4
BULA 264	Computer Appli. & the Law	4
BULA 269	Criminal Law/Criminal Procedure	4
	Total	16
FIFTH QUARTER		
BUAC 101	Accounting 1	4
BULA 212	Real Estate Law for Legal Assist.	4
BULA 265	Family Law	4
BULA 270	Evidence	4
	Totals	16
SIXTH QUARTER		
BUAC 102	Accounting 2	4
BULA 266	Wills, Trusts, and Estate Admin.	4
BULA 267	Legal Assisting Practicum	4
ENGL 121	Technical Writing	3
PHIL 320S	Ethics in Public & Private Life	4
	OR	
BUMG 331	Business Ethics OR	
BULA 272	Ethics for Legal Assistants	4
	Total	19

Legal Assisting Technology 1+1

Shawnee State's Department of Business Administration, in collaboration with Southern State Community College, South Campus (Sardina, Ohio), offers a 1 + 1 legal assisting program when demand is sufficient. The

program is designed for students who complete the first year of the legal assisting program at Southern State Community College, South Campus, and who wish to complete the second year of the legal assisting technology program at Shawnee State University. The four legal assisting courses which are offered during the first year are BULA 101 Introduction to Legal Assisting and BULA 251 Legal Research and Writing 1, winter quarter, and BULA 252 Legal Research and Writing 2 and BULA 262 Introduction to Civil Litigation, both offered during the spring quarter. For additional information, contact Karen S. Crummie, J.D., at (614) 355-2575.

Minor

Health Management

The health management minor is designed for students enrolled in clinical health care programs who wish to develop their managerial skills. (It should be noted that the minor does not qualify a person to sit for the national and state nursing home license exam.) The minor requires 28 hours of health management courses. Please check the course description section of this catalog to see whether prerequisites need to be met.

Required Courses

Course No.	Course	Cr. Hrs.
BUHE 310	Orient. to Health Care Systems	4
BUHE 312	Health Care Personnel Mgt.	4
BUHE 410	Pat. Care in Ext. Care Facil. OR	4
BUHE 415	Admin. in Acute Care Facilities	
BUHE 411	Admin. in Extended Care Facil. OR	4
BUHE 416	Mgt. Issues in Acute Care Facil.	
BUHE 420	Prob. in Hlth. Care Mgt. & Policy	4

Optional Courses

Complete at least 8 hours from the following.

BUAC 410	Health Care Acctg./Admin.	4
BUHE 314	Community Health Programs	4
BUHE 430	Health Care Reimb. & Payments	4
BULW 270	The Legal Environment of Bus.	4
BUMK 310	Marketing Principles	4

BUHE 410, 411, 415, or 416 are also optional if not taken as one of the required courses.

New Program

A bachelor of science in business administration with a concentration in accounting is being developed by the accounting faculty. The new concentration should be available by fall, 1997.

For additional information contact the accounting advisor or the chairperson of the Department of Business Administration.



**Health
Sciences**

Health Sciences

The Department of Health Sciences serves the tri-state area by educating and preparing competent and responsible health-care professionals so that they can deliver the best quality health care possible. The Department of Health Sciences also fosters professionalism, personal growth and development, and self-actualization and is committed to continuing professional development for the health care practitioners in the tri-state area.

For General Information

James R. Kadel, M.B.A., D.D.S., Dean
Ann McCarthy, Secretary
College of Professional Studies
Health Sciences Building
Phone: (614) 355-2270
Fax: [614] 355-2354
E-mail: amccarthy@shawnee.edu

For Health Sciences Admission Information

Cindy Haney, Health Sciences Representative
Office of Admission
Shawnee State University
940 Second Street
Portsmouth, Ohio 45662-4344
Phone: (614) 355-2209
Fax: [614] 354-7794
E-mail: chaney@shawnee.edu

Degrees in the Health Sciences

Bachelor of Science
Medical Laboratory Science
Occupational Therapy

Associate of Applied Science
Associate Degree Nursing
Dental Hygiene

Associate of Applied Science (cont'd.)

Emergency Medical Technology
Medical Laboratory Technology
Occupational Therapy Assistant
Physical Therapist Assistant
Radiologic (X-ray) Technology
Respiratory Therapy

Associate of Individualized Studies

See page 103 of the current catalog for description.

Bachelor Degrees

Bachelor of Science in Medical Laboratory Science

To become a medical technologist/clinical laboratory scientist, students can complete an NAACLS-accredited bachelor of science degree program in medical laboratory science (MLS). The MLS program at Shawnee State University is a 2+2 program in which the first seven quarters follow the associate degree curriculum to enable the student to become a certified medical laboratory technician (MLT). Certified MLTs from NAACLS-accredited programs are then eligible to apply for admission to the MLS/MT bachelor of science program to complete the final seven quarters to meet national certification requirements as a medical technologist (MT) or clinical laboratory scientist (CLS).

Accreditation and Certification

The medical laboratory programs at Shawnee State are and will be nationally accredited by the National Accrediting Agency for Clinical Laboratory Science (NAACLS). Graduates of the bachelor degree program in medical laboratory science are qualified to be nationally certified by the American Society of Clinical Pathologists (ASCP), as medical technologists, MT (ASCP), and by the National Certification Agency for Medical Laboratory Personnel (NCA) as clinical laboratory scientists, CLS (NCA).

Admission Requirements

Due to limited enrollment for this program, a selective admission process is followed. Certified MLTs are selected from those who have met the following minimum criteria:

- Application to Shawnee State University with current, nonrefundable application fee (for new students to SSU only).
- "Change of Major" form, indicating application to medical laboratory science BS degree program (for SSU MLT graduates).
- Successful completion of an NAACLS-

accredited medical laboratory technician program at the associate degree level with a cumulative GPA of 3.0 or above on a 4.00 scale, based on courses listed below.

Completion of the following courses or their equivalents at the time of application to the BS degree program.

- BIOL 151, 162, 350
- CHEM 141, 142, 143, 305
- ENGL 111S, 112S
- MATH 130, 131
- SOCI 101
- SPCH 103
- MLTC 111, 112, 201, 202, 203, 204, 207, 209, 210, 211, 212, 213, 215, 216, 217, 220, 221, 225

Individuals with nontraditional academic histories who are certified MLTs and have a minimum of three years clinical laboratory experience in ASCP/NCA-defined clinical areas may apply for credit by examination toward completion of MLTC requirements.

- Completion of MLT entrance examinations.
- ASCP or NCA certification as a medical laboratory technician (MLT).
- Documentation of a minimum of 80 hours of verified work or volunteer experience in a hospital-based clinical laboratory with acceptable clinical experience in the areas of blood banking, clinical chemistry, hematology, microbiology, immunology, microscopy, and body fluids under the supervision of a pathologist or certified medical technologist/clinical laboratory scientist.
- Completion of all entrance examinations and required materials by July 1. All late applicants are considered on a space available basis.

Degree Requirements

General Education Program

The General Education Program is composed of 48 credit hours of which 16 hours may be satisfied by CHEM 141, CHEM 142, CHEM 143, and MATH 131. Further information about the GEP is listed on page 55 of the current catalog or can be obtained from the dean's office.

32 Hours

Medical Laboratory and
Biomedical Science Require.
Other Required Courses
Minimum Hours Required

113 Hours
46 Hours
191 Hours

Medical Laboratory and Biomedical Science Requirements (113 Hours)

Course No.	Course	Cr. Hrs.
BMSC 411	Medical Biochemistry	4
BMSC 432	Molecular Biology	4
BMSC 450	Medical Immunology	4
MLSC 310	Clinical Microbiology 2	3
MLSC 315	Blood Banking 2	3
MLSC 340	Procedure Evaluation and QC	2
MLSC 350	Clinical Instrumentation	3
MLSC 410	Clinical Correlations 1	4
MLSC 415	Clinical Correlations 2	4
MLSC 420	Laboratory Management	3
MLSC 425	Clinical Education Methodology	2
MLSC 430	Clinical Practicum 3	6
MLSC 440	Clinical Practicum 4	9
MLSC 490	MLS Seminar	4
MLSC 499	Special Topics in MLS	2
MLTC 111	Medical Laboratory Orientation	2
MLTC 112	Basic Laboratory Skills	3
MLTC 201	Urinalysis	3
MLTC 202	Immunoserology	4
MLTC 203	Blood Banking 1	1
MLTC 204	Parasitology	5
MLTC 207	Clinical Microbiology 1	4
MLTC 209	Hematology 1	2
MLTC 210	Hemostasis	3
MLTC 211	Hematology 2	4
MLTC 212	Clinical Chemistry 1	3
MLTC 213	Clinical Chemistry 2	3
MLTC 215	Lab Simulation	1
MLTC 216	Medical Technology Seminar	1
MLTC 217	Case Studies	4
MLTC 220	Clinical Practicum 1	8
MLTC 221	Clinical Practicum 2	8
MLTC 225	Special Problems in Med Lab	2

Other Required Courses (46 Hours)

BIOL 151	Principles of Biology	5
BIOL 162	Anatomy & Physiology	5
BIOL 350	Microbiology	5
BUIS 101	Intro. to Computer Info. Systems	4
CHEM 141	General Chemistry 1	4
CHEM 142	General Chemistry 2	4
CHEM 143	General Chemistry 3	4
CHEM 305	Organic Chemistry 1	4
MATH 130	Intermediate Algebra	4
MATH 131	College Algebra	4
SPCH 103	Public Speaking	3

Bachelor of Science in Occupational Therapy

To become an occupational therapist, a student must complete an educational program in occupational therapy at either the baccalaureate or graduate level. The program at Shawnee State University leads to a bachelor of science degree with a concentration in occupational therapy. Studies include basic academic courses in the sciences and liberal arts as well as occupational therapy theoretical constructs and practices. The occupational therapy program requires six to nine months of full-time (usually 40 hours per week) internships in a variety of health care settings. You are responsible for your own transportation to and from clinical facilities as well as any other costs associated with clinical placements.

To ensure continuity of application of academic concepts, all fieldwork must be completed within 24 months following academic preparation and 2 months prior to the NBCOT Certification Examination date.

Accreditation

The occupational therapy program is accredited by the Accreditation Council for Occupational Therapy Education (ACOTE) of the American Occupational Therapy Association (AOTA), located at 4720 Montgomery Lane, P.O. Box 31220, Bethesda, MD 20824-1220. AOTA's phone number is (301) 652-AOTA. Graduates of the program are able to sit for the national certification examination for the occupational therapist administered by the National Board for Certification in Occupational Therapy, Inc. (NBCOT); however, the NBCOT sets its own criteria for taking the exam, which may include questions on the applicant's criminal history. For more information on these limitations, you can contact NBCOT at (301) 990-7979. After successful completion of this exam, you are an occupational therapist, registered (OTR). Most states require licensure in order to practice; however, state licenses are usually based on the results of the NBCOT Certification Examination.

Admission Requirements

Due to limited enrollment for this program, a selective admission process is followed.

Students with a standing of second quarter freshmen or more are considered for admission

to the occupational therapy bachelor's program. Students will be admitted to the professional courses during winter quarter.

Candidates are selected from applicants who have met the following *minimum* criteria:

- Application to Shawnee State University with current, nonrefundable application fee (new students).
- "Change of Major" form, indicating application to occupational therapy B.S. program (current students).
- Cumulative GPA of 2.5 or above on a 4.0 scale based on courses listed under 'A' below.
- Cumulative GPA of 2.5 or above on a 4.0 scale at time of enrollment in the professional program.
- A minimum grade of "C" in all prerequisite courses at time of application.
- Completion of either high school or college chemistry with a grade of "C" or higher. Students who use high school chemistry to meet this requirement also need to take college chemistry as part of the OT curriculum.
- Completion of 40 hours verified volunteer experience in an occupational therapy setting OR certification as an occupational therapy assistant (proof of certification is required).
- Completion of the following courses at the time of application: (*Check course prerequisites in the "Course Description" section of the current university catalog. More coursework may be necessary than is indicated here.*)
 - AHNR 102 (Medical Terminology)
 - ARTS 231 or fine arts GEP course
 - Introductory college level biology (BIOL 101, 151, or NTSC 110S)
 - ENGL 111S, 112S
 - Mathematics (MATH 110S, 130, or 150)
 - PSYC 101
 - SOCI 101
- Successful completion of the following courses prior to admission to the program: (*Check course prerequisites in the "Course Description" section of the current university catalog. More coursework may be necessary than is indicated here.*)
 - AHNR 102
 - ARTS 231
 - BUAI 101 or BUIS 101
 - CHEM elective

- Cultural perspectives, 4 of 8 hours
- ENGL 111S, 112S, and 115S
- MATH 150
- NTSC 110S, BIOL 101 or 151, and 310
- PHYS 201
- PSYC 101 and 151
- SOCI 101

■ Completion of all required forms and requested materials by the application deadline.

Requirements for graduation and to remain in the program are listed in the *OT Student Handbook*.

Degree Requirements

General Education Program 48 Hours

Further information is listed on page 55 of the current catalog or can be obtained from the dean's office.

Required OT Courses 89 Hours

Other Required Courses 52 Hours

Minimum Hours Required 189 Hours

Required Occupational Therapy Courses (89 Hours)

Course No.	Course	Cr. Hrs.
OTST 101	Intro. to Occupational Therapy	4
OTST 103	Disease Pathology 1	4
OTST 110	Group Dynamics	2
OTST 205	Therapeutic Media 2	3
OTST 206	Contemporary Media in OT	2
OTST 305	Disease Pathology 2	4
OTST 310	Practicum 1 for OTS	2
OTST 330	Orthotics	3
OTST 410	OT in Physical Disabilities 1	4
OTST 411	OT in Physical Disabilities 2	4
OTST 412	OT in Mental Health 1	4
OTST 413	OT in Mental Health 2	4
OTST 416	OT in Gerontology	4
OTST 420	Practicum 2 for OTS	2
OTST 421	Practicum 3 for OTS	2
OTST 430	OT in Devel. Disabilities 1	5
OTST 431	OT in Devel. Disabilities 2	4
OTST 450	Rsrch. Dsgns. & Mthds. in OT	4
OTST 451	OT Mgt. & Program Planning	4
OTST 495	Clinical Application 1	12
OTST 496	Clinical Application 2	12
OTST 497	Clinical Application 3	4, 8, or 12

Other Required Courses (52 Hours)

AHNR 102	Medical Terminology	2
ARTS 231	Ceramics 1	4
BIOL 101	Introduction to Biology OR	3
BIOL 151	Principles of Biology (5 cr. hrs.)	
BIOL 310	Principles of Anatomy	5
BIOL 311	(Counts as part of the GEP)	(4)
BIOL 314	Human Neuroanatomy	5
BIOL 320	Principles of Physiology	5
BUAI 101	Intro. to Auto. Info. Syst. OR	4

BUIS 101	Intro. to Computer Info. Syst.	4
CHEM	Elective (100 level or higher)	(4)
MATH 150	(Counts as part of the GEP)	4
PHYS 201	Physics 1 (Mechanics)	4
PSYC 101	Introduction to Psychology	4
PSYC 151	Human Growth & Develop.	4
PSYC 400	Abnormal Psychology	(4)
SOCI 101	(Counts as part of the GEP)	(4)
SOCI 330	Social Theory	4

Associate Degrees

Minimum Admission Requirements for Associate Degree Programs

The following requirements apply to all associate degree health science programs:

■ New students must submit an application to Shawnee State University, along with the current nonrefundable application fee.

■ Current Shawnee State students wishing to apply for admission to a health science associate degree program should complete a "Change of Major" form, indicating the program(s) for which they are applying.

■ Official high school transcript or GED test score transcript (along with partial high school transcript) and official college transcripts must be submitted.

Please note: Transcripts may be sent directly from the high school or applicants may hand-carry the transcript in an envelope sealed with a guidance counselor's signature. Guidance counselors or high school officials may send transcripts via FAX to [614] 354-7794 if accompanied by a signed transmittal form or by electronic transfer. The University reserves the right to verify the final, official authenticity of any student's transcript. Any transcript document found to be fraudulent becomes the student's responsibility and the University reserves the right to withdraw admission acknowledgement and/or approval of acceptance.

College transcripts must be sent directly from the school to Shawnee State to "be official." Photocopies, fax, and hand-carried transcripts are not accepted.

■ Students must have a "C" or above in algebra, biology, and chemistry requirements.

continued on page 123

Associate Degree Admission Requirements

	High School or College Algebra, Biology, and Chemistry (C or above)	20 Hours Volunteer or Work Experience with Disabled or Handicapped	ACT Score of 18 in Science Reasoning Section	ACT Score of 18 in EACH area	SSU MATH/ENGL Placement Score OR Transfer Credit Equivalent to:
Associate Degree Nursing ¹	✓			✓	ENGL 111S
Dental Hygiene	✓		✓		
Emergency Medical Technology	✓				
Medical Laboratory ²	✓		✓		ENGL 111S MATH 130
Occupational Therapy Assistant	✓	✓ ³			
Physical Therapist Assistant	✓	✓			ENGL 111S MATH 101
Radiologic Technology ⁴	✓		✓		ENGL 111S MATH 130
Respiratory Therapy ⁴	✓		✓		ENGL 111S MATH 130

The chart above indicates requirements of individual associate degree health science programs.

¹ ADN applicants must be eligible for ENGL 111S. Students must also be eligible for BIOL 310 by fall 1997.

² Lower placement scores will be accepted on the condition that the student has successfully completed prerequisite coursework for ENGL 111S and/or MATH 130 prior to entry into the MLT program.

³ Applicants to the occupational therapy assistant program must work under the direct supervision of either a licensed occupational therapy assistant or occupational therapist.

⁴ Radiologic technology and respiratory therapy applicants must be eligible to enter MATH 130 and ENGL 111S as the program curriculum describes.

A "C-" is not accepted. Students with a "C-" average in one of these courses are not considered for admission.

- If the ACT test was taken before October 1989, students must have a score of "16" in the published requirement areas. On tests taken October 1989 or later, students must have a score of "18" in the published requirements.
- Students may be required to complete an "Autobiography Form," which is provided to students after the application to the University is received.
- Applicants to the physical therapist assistant or occupational therapy assistant programs are required to complete a minimum of 20 hours volunteer or work experience in a facility serving the disabled or handicapped. OTA applicants must work under the direct supervision of either a licensed occupational therapy assistant or occupational therapist. Appropriate forms are provided to students after the application to the University is received.
- When all minimum admission criteria have been met, files are forwarded to the appropriate department's chairperson. Students are not considered for admission to a health science program until all minimum admission requirements are completed.
- Applicants to the medical laboratory program have a meeting with the department's chairperson when their file is complete. Applicants to other programs are contacted if further information is needed.
- Physical examinations are required for students who have been officially accepted into a health science program. Forms are provided by the department.

Questions regarding admission procedures or application status should be directed to the health sciences representative in the Office of Admission at (614) 355-2209.

Deadline for Receipt of ALL Application Materials:

After the application deadlines listed below, students who have completed application materials are accepted on a space-available basis.

February 1

Associate Degree Nursing
Physical Therapist Assistant

April 1

Dental Hygiene
Medical Laboratory
Occupational Therapy (B.S. degree)
Radiologic Technology
Respiratory Therapy

May 15

Occupational Therapy Assistant

Selective Admission Criteria

Fulfilling the criteria for admission into a health sciences program does not automatically guarantee entrance into the program. Since the number of candidates who meet the minimal criteria for admission generally far exceeds the number of vacancies, each program ranks the candidates using selected criteria in addition to the minimal admission requirements. For example, this additional criteria may include, but is not limited to, high school and/or college grade point average; completion of additional coursework in college level biology, mathematics, and chemistry; work experience; and autobiographies. You may obtain information about the criteria used for the ranking of applicants by contacting the department's chairperson or the dean's office.

Hospital Clinical Sites

Some health science programs utilize hospital clinical sites for the completion of their requirements for graduation. These affiliating hospitals have the right to accept or reject a student, which could result in your being delayed in a program or unable to complete the requirements for graduation. If you have a conviction record for certain classes of misdemeanors or any felony, you may be ineligible for licensure in specific health occupations. Also, the affiliating hospitals have the right to reject students due to a criminal record.

Health Science Class Scheduling

The majority of all health science classes are scheduled between 8:00 a.m. and 5:00 p.m. However, you need to know that it may be necessary to schedule your required classes in English, natural sciences, and humanities during the evening hours as the required clinical and laboratory times in the health science courses involve many hours during the 8:00 to 5:00 day schedules.

Pass/No-Credit Policy

Students in health science programs are not permitted to take courses on a pass/no-credit basis. This applies to courses taken in preparation for admission to the health science programs as well as courses taken after admission to a program. Classes may be taken for non-credit, but only with the prior permission of the health science department's chairperson.

Guidelines for Appealing a Dismissal From a Health Science Program

Each of the programs within the Department of Health Sciences has set minimum academic and clinical performance standards which permit a student to continue in that program. Failure to meet these minimum performance standards will result in dismissal from the program. Information concerning these performance standards is available in this catalog, the student handbook for the individual program, or from the office of the program's chairperson.

If you wish to appeal your dismissal from a health science program, the following sequence of events shall be followed:

- Within three working days following your notification of dismissal from the health science program, you must request in writing a meeting with the program's chairperson to appeal the dismissal. You will be notified of the results of this appeal within two working days following this meeting. If you are unsatisfied with the decision, you may request, within three working days, a second appeal hearing.
- Upon your written request for the next level of appeal, the program's chairperson will arrange a joint meeting with you, the chairperson (or designee), the dean of the College of Professional Studies (or designee), and the provost (or designee). You will be notified of the results of this appeal hearing within two working days following the meeting.

Criteria to be used in ruling on your dismissal appeal include your past academic achievement, your rationale for current grade status, and the prediction of future performance in the program.

Dismissal from a health science program is not the same as dismissal from the University.

University dismissal policies are outlined in this catalog under the section titled "Academic Policies."

Associate Degree Nursing

Associate degree nursing students graduating from Shawnee State University are qualified to take the NCLEX-RN examination¹ for registered nurses and, after successfully passing this examination, are capable of providing nursing care at a beginning level in hospitals, nursing homes, doctors' offices, clinics, and selected public health agencies.

Accreditation

The associate degree nursing program has full approval of the Ohio Board of Nursing.

Please Note

- All suggested or equivalent courses listed for the first three quarters must be completed by the end of the third quarter and prior to continuing into the second year. Prerequisites for each quarter are identified under course descriptions.
- For a student to remain in good academic standing in the associate degree nursing program, a grade of "C" (2.0) or better must be achieved in each course included in the curriculum. Failure to do so may result in academic dismissal from the program. Students requesting readmission must do so in writing within one quarter of leaving the program in order to obtain the requirements and forms from the nursing department.
- Only those students who have been officially accepted into the program or who have received the approval of the department's chairperson may take the courses beginning with the ADNR prefix.
- Students must have current CPR certification or enroll in EMTA 102.
- It is recommended that students take BIOL 101/151 before fall 1996.

¹ Felony conviction requires permission from Ohio Board of Nursing before taking the examination.

Sample Schedule

Course No.	Course	Class Hrs.	Lab Hrs.	Credit Hrs.
FIRST QUARTER				
ADNR 101	Nursing 1	5	9	8
AHNR 103 ¹	Prin. of Medical Science	3	0	3
BIOL 101 ¹	Introduction to Biology	3	0	3
ENGL 111S	Discourse and Comp.	4	0	4
	Totals	15	9	18
SECOND QUARTER				
ADNR 102	Nursing 2	5	9	8
BIOL 310	Principles of Anatomy	4	3	5
PSYC 101	Intro. to Psychology	4	0	4
	Totals	13	12	17
THIRD QUARTER				
ADNR 103	Nursing 3	4	12	8
BIOL 320	Principles of Physiology	5	0	5
PSYC 151	Human Grow. and Devel.	4	0	4
	Totals	13	12	17
SUMMER QUARTER (Optional): The following courses may be taken in the summer or during the second year as designated.				
BIOL 350	Microbiol. 1 (or 4th qtr.)	4	3	5
ENGL 112S	Comp. & Rsrch. (or 5th qtr.)	4	0	4
SOCI 101	Intro. to Soc. (or 5th qtr.)	4	0	4
	Totals	12	3	13
FOURTH/FIFTH QUARTER				
ADNR 201 ²	Nursing 4	6	12	5
ADNR 202 ²	Nursing 5	6	12	5
ADNR 203	Nursing 6	2	0	2
BIOL 350	Microbiol. 1 (4th qtr.)	4	3	5
	Totals	12	15	12
FOURTH/FIFTH QUARTER				
ADNR 204	Nursing 7	6	12	10
ENGL 112S	Comp. & Rsrch. (5th qtr.)	4	0	4
SOCI 101	Intro. to Soc. (5th qtr.)	4	0	4
	Totals	14	12	18
SIXTH QUARTER				
ADNR 205	Nursing 8	4	15	9
ADNR 211	Nursing 9	3	0	3
	Approved Elective ³	4	0	4
	Totals	11	15	16

Dental Hygiene

Dental hygiene is a vital health service component of dentistry which emphasizes oral health and the prevention of oral diseases.

Most dental hygienists are employed in private dental offices or clinics and work under the supervision of the dentist. The hygienist's main function is performing oral prophylaxis—

scaling and polishing of the patient's teeth to remove soft and hard deposits. They also perform other procedures, such as dental charting and oral examinations, exposing and processing dental radiographs, fluoride treatments, and preliminary impressions for study models. The hygienist also places great emphasis on dental health education, home care, brushing/flossing, and diet/nutritional counseling.

Accreditation

The dental hygiene program is accredited by the American Dental Association—Commission on Dental Accreditation.

Job Opportunities

Hygienists are employed with dentists in private practice as well as in the following areas:

- **School systems** Primarily concerned with the proper care of children's teeth. Inspect students' teeth and report findings to a supervising dentist. May also instruct students in proper care of teeth, give demonstrations on the proper use of a toothbrush, and present talks on nutrition and its effects on dental health.
- **Hospitals and clinics** Concerned primarily with the special oral health problems of the bedridden and chronically ill.
- **Teaching and research** Hygienists with advanced degrees may be employed in research or may teach in dental hygiene educational programs that help students to prepare for the profession.

Academic Requirements

In order to remain in good academic standing in the dental hygiene program, you must:

- Maintain a cumulative GPA of 2.0 in all coursework needed to meet the requirements for an associate of applied science degree in dental hygiene. This applies to all required courses taken before as well as after admission into the dental hygiene program.

¹ Students who are planning to continue their education toward a baccalaureate degree are encouraged to substitute CHEM 121 for AHNR 103 and BIOL 151 for BIOL 101. BIOL 101/151 will be required before fall 1997.

² May be half-quarter course.

³ Elective must be approved by nursing advisor.

- Maintain a cumulative GPA of 2.0 in all dental hygiene courses.
- Not receive a failing grade in any of the required courses for the dental hygiene program.

Students who fail to achieve any one of the three requirements for good academic standing will be dismissed from the dental hygiene program with the option of reapplying for admission the following year. You may appeal a dismissal from the dental hygiene program by following the guidelines for appeal as detailed in this catalog.

Please Note

- After the first quarter, all subsequent basic and technical courses are closely related and, therefore, must be taken in sequential order.
- Only those students who have been officially accepted into the program or who have received the approval of the department's chairperson may take the courses beginning with the DTHY prefix.

Sample Schedule

Course No.	Course	Class Hrs.	Lab Hrs.	Credit Hrs.
FIRST QUARTER				
AHNR 103	Prin. of Medical Science	3	0	3
BIOL 101	Introduction to Biology	3	0	3
DTHY 111	Oral Anatomy 1	3	0	3
DTHY 121	Clinical Dental Hygiene 1	2	6	4
	Totals	11	6	13
SECOND QUARTER				
BIOL 162	Human Anat./Phys.	4	3	5
DTHY 101	Radiology 1	2	0	2
DTHY 102	Oral Histology/Embryo	2	0	2
DTHY 112	Oral Anatomy 2	2	0	2
DTHY 122	Clinical Dental Hygiene 2	2	6	4
	Totals	12	9	15
THIRD QUARTER				
DTHY 113	Radiology 2	1	3	2
DTHY 123	Clinical Dental Hygiene 3	2	8	5
DTHY 202	Periodontics	3	0	3
DTHY 220	Oral Microbiol./Immun.	3	0	3
	English/Human./Social Sc.	4	0	4
	Totals	13	11	17
FOURTH QUARTER (Summer)				
DTHY 203	Dental Materials	2	3	3
DTHY 205	Dental Health Education	3	0	3

DTHY 224	Clin. D. H. 4/Off. Emerg.	2	9	5
DTHY 290	Sem./Adv. Periodontics	1-3	0	1-3
	Totals	8-10	12	12-14

FIFTH QUARTER

DTHY 103	Human Nutrition	3	0	3
DTHY 201	Gen. and Oral Pathology	3	0	3
DTHY 225	Clin. D. H. 5/Spec. Needs	2	9	5
	English/Human./Social Sc.	4	0	4
	Totals	12	9	15

SIXTH QUARTER

DTHY 204	Pharmacology	3	0	3
DTHY 206	Public Health	3	0	3
DTHY 226	Clin. D.H. 6/Prv. Dnt. & Jrs.	1	12	5
	English/Human./Social Sc.	4	0	4
	Totals	11	12	15

SEVENTH QUARTER

DTHY 227	Clin. D.H. 7/Career Mgt.	1	9	4
	English/Human./Social Sc.	7	0	7
	Elective	3	0	3
	Totals	11	9	14

Emergency Medical Technology

Emergency medical technicians are health care professionals who provide emergency treatment to patients in the prehospital environment. They are familiar and comforting figures at the scene of an accident or medical emergency, where their special skills often mean the difference between life and death.

Careers in prehospital care are challenging and exciting. They require students who possess leadership skills, are good decision makers, can remain calm in emergency situations, and who are compassionate and caring.

Emergency medical technicians work directly with physicians in correlating and providing care to patients experiencing illness or injury.

Several levels of training are available at Shawnee State for emergency medical technicians. The entry level for the profession is the **Emergency Medical Technician - Basic (EMT-B)**. Education for this level of emergency care is the 140-hour Emergency Victim Care Course (EMTP 110).

The **Emergency Medical Technician - Advanced (EMT-A)** provides emergency care at a high level, utilizing advanced skills in airway and shock management. Educational preparation for the advanced EMT-A is included in EMTP 210 through 212.

¹ English/Humanities/Social Science Requirements: ENGL 111S, ENGL 112S, PSYC 101, SPCH 103, SOCI 101.

² 3-Credit Hour Elective: Any English, psychology, speech, or sociology course with a catalog number higher than the required courses listed above. Any business management, personnel management, computer course, or HPER 202 - Personal and Community Health.

The **Emergency Medical Technician - Paramedic (EMT-P)** is the highest level of certified emergency care provider. The paramedic receives education in a program of study encompassing seven courses in addition to the EMT-A and advanced EMT-A courses (EMTP 210 through 241). This education includes classroom and laboratory instruction, as well as hospital and field clinical experiences.

An exciting opportunity exists for EMT-P students at Shawnee State. Students can pursue the associate of applied science degree in emergency medical technology. This two-year program is intended to expand the knowledge and experience base of the EMT-Paramedic in both general academics and prehospital emergency medicine. Completion of this program prepares the paramedic student for supervisory positions, advanced clinical procedures, as well as teaching opportunities in EMS. This degree may be pursued as part of the initial educational experience or for career advancement.

Certification

Upon successful completion of:

- **EMTP 110:** Students are eligible to sit for the Basic National Registry Exam. Upon successful completion of the exam, the student receives Ohio and National Registry certification as an EMT-Basic.
- **EMTP 210-212:** Students are eligible to sit for the Intermediate National Registry Exam. Upon successful completion of the exam, the student receives Ohio and National Registry certification as an Intermediate EMT.
- **EMTP 210-242:** Students are eligible to sit for the Paramedic National Registry Exam. Upon successful completion of the exam, the student receives Ohio and National Registry certification as a Paramedic (EMT-P). Upon completion of the two-year program, the student receives the associate of applied science degree.

Accreditation

The EMT-B and paramedic training programs have received accreditation from the Ohio Department of Public Safety, Division of Emergency Medical Services.

Employment Opportunities

Positions for emergency medical technicians are available in private ambulance companies, hospitals, industry, fire departments, 911 dispatch offices, and the armed forces. Law enforcement agencies, park services, ski patrols, and other groups train their personnel to become EMT-Bs or paramedics as part of their duties.

Academic Requirements

In order to remain in good academic standing in the emergency medical technology program, you must:

1. Maintain a grade point average of 2.0 in all coursework needed to meet the requirements for an associate of applied science degree in emergency medical technology. This applies to all required courses taken before, as well as after, admission in the emergency medical program.
2. Maintain a grade point average of 2.0 in all emergency medical technology courses.
3. Not receive a failing grade in any of the required courses for the emergency medical technology program.

Students who fail to achieve any one of the three requirements for good academic standing will be dismissed from the emergency medical technology program with the option of reapplying for admission the following year. You may appeal a dismissal from the emergency medical technology program by following the guidelines for appeal as detailed in this catalog.

Please Note

- After the first quarter, all subsequent basic and technical courses are closely related and, therefore, must be taken in sequential order.
- Only those students who have been officially accepted into the program or who have received the approval of the department's director may take the courses beginning with the EMTP prefix, except EMTP 101 and 102.

Entrance Requirements

EMT-B Course (EMTP 110)

- Minimum of 18 years of age
- High school diploma or equivalent
- Current, unconditional driver's license
- Completed Pre-Entrance Medical Record with recent TB and Tetanus
- Evidence that you have not been convicted of, pled guilty to, or had a judicial finding of guilt for any of the following: fraud or material deception in applying for or obtaining a certificate to practice; any of the following felonies: murder, aggravated murder, voluntary manslaughter, felonious assault, kidnapping, rape, sexual battery, gross sexual imposition, aggravated arson, aggravated robbery, aggravated burglary; a misdemeanor, other than a traffic violation committed in the course of practice; a misdemeanor involving moral turpitude; a violation of any federal, state, county, or municipal narcotics law; any act committed in another state, that, if committed in Ohio, would constitute a violation set forth in 4765-8-01 (A) (3) (b) of the Ohio Administrative Code.

Advanced EMT-A Course (EMTP 210, EMTP 211, EMTP 212)

All EMT-B requirements, and:

- Completed University application
- Current Ohio EMT-A certification
- Evidence of not less than six months' experience providing prehospital care in the prehospital setting
- Letter of recommendation from a supervisor of the emergency medical service with which the above requirement was met
- Conference with the director of the department, showing evidence of maturity, good judgement, and good moral character
- Completion of an examination which addresses aptitude in reading, writing, and mathematics skills. Remedial education in deficient areas may be required. Paramedic Program (EMTP 210 through 242) All EMT-A requirements, and:
- Successful completion of the national registry of EMT's basic or intermediate level examination

Associate of Applied Science Emergency Medical Technology Curriculum

Course No.	Course	Class Hrs.	Lab Hrs.	Credit Hrs.
FIRST QUARTER				
AHNR 102	Medical Terminology	2	0	2
BIOL 101	Introduction to Biology	3	0	3
EMTP 102	Cardiopulm. Resuscitation	1	0	1
EMTP 110	Emergency Victim Care	9	3	10
	Totals	15	3	16
SECOND QUARTER				
EMTP 120	EMS Systems	3	0	3
ENGL 111S	Discourse & Composition	4	0	4
PSYC 101	Intro. to Psychology	4	0	4
SPCH 103	Pub. Spk. and Hum. Com.	3	0	3
	Totals	14	0	14
THIRD QUARTER				
BUIS 101	Intro. to Auto. Info. Sys.	4	0	4
EMTP 130	Major Incident Response	2	0	2
ENGL 112S	Composition and Research	4	0	4
SOCI 101	Introduction to Sociology	4	0	4
	Totals	14	0	14
FOURTH QUARTER (optional)				
XXX	General Elective			
FIFTH QUARTER				
EMTP 210	Paramedic Skills 1	5	0	5
EMTP 211	Paramedic Skills 1 Lab	0	2	1
EMTP 212	Paramedic Skills 1 Clinical	0	4	1
EMTP 220	Paramedic Skills 2	3	2	3
XXX	General Elective	4-5	0	4-5
	Totals	12-13	8	14-15
SIXTH QUARTER				
EMTP 230	Paramedic Skills 3	8	0	8
EMTP 231	Paramedic Skills 3 Lab	0	3	1
EMTP 232	Paramedic Skills 3 Clinical	0	4	1
XXX	EMS Elective	1-4	0	1-4
XXX	General Elective	4-5	0	4-5
	Totals	13-17	7	15-19
SEVENTH QUARTER				
EMTP 240	Paramedic Skills 4	8	0	8
EMTP 241	Paramedic Skills 4 Lab	0	3	1
EMTP 242	Paramedic Skills 4 Clinical	0	4	1
EMTP 250	Adv. Emerg. Procedures	2	2	3
XXX	General Elective	4-5	0	4-5
	Totals	14-15	9	17-18

Approved Electives (To total 23 to 37 credits)

Choose at least two of the following:

Course No.	Course	Cr. Hrs.
AHNR 312	Health Care Personnel Mgt.	4
BIOL 151	Principles of Biology	5
BIOL 162	Human Anatomy and Physiology	5
BIOL 310	Principles of Anatomy	5
BIOL 320	Principles of Physiology	3
BIOL 321	Human Physiology Lab	2
BIOL 350	Microbiology	5
ENGL 115S	Composition and Literature	4
MATH 110S	Mathematics Core Course	4
SOCI 110S	Foundations of Social Science	4

Choose at least two of the following:

BUMG 210	Management Concepts	4
BUMG 235	Personnel Management	4
ECON 101	Principles of Economics	4
PSYC 151	Human Growth and Develop.	4
PSYC 405	Death and Dying	4

Technical Electives

EMTP 212	Advanced EMT Defibrillation	4
EMTP 260	EMS Field Studies	3
EMTP 270	EMS Management	3
EMTP 295	Special Topics in EMS	1-4

Medical Laboratory Technology

Medical laboratory technology is a profession which combines the challenges and rewards of medicine and science. Billions of laboratory procedures are ordered by physicians and performed by certified laboratory technicians and technologists. They range from simple pregnancy testing to more complex procedures for detecting such diseases as diabetes, anemia, and cancer. Medical laboratory technology is concerned with the accurate performance of these tests to determine the absence, presence, extent, and causes of disease.

Graduates of this nationally accredited, two-year associate degree program are eligible to be certified by nationally-recognized certification agencies. They work under the supervision of a pathologist or technologist/laboratory scientist and are qualified to perform a wide array of analytical tests in the areas of hematology, microbiology, chemistry, blood banking, coagulation, serology, and urinalysis. MLTs may work in community hospital laboratories, as well as private, industrial, and reference laboratories. Physician's office laboratories, state and federal agencies, and the military are also sources of employment for certified medical laboratory technicians.

The curriculum consists of seven continuous quarters of general education, basic science, and clinical laboratory science coursework, including an 18-week internship in an affiliated hospital.

Certification

Upon successful completion of this program, graduates are awarded the associate of applied science degree and are eligible to become nationally certified by the American Society of

Clinical Pathologists (ASCP) and/or the National Certification Agency for Medical Laboratory Personnel (NCA) as a medical laboratory technician.

Accreditation

The MLT program is nationally accredited and recognized by the National Accrediting Agency for Clinical Laboratory Sciences (NAACLS).

Employment Opportunities

Health care continues to be one of the fastest growing service industries in the United States. Employment opportunities are generally available within our geographical area as well as throughout the United States.

Scholarships

A medical laboratory scholarship is awarded each year to a high school graduate who demonstrates academic excellence and has been admitted into the medical laboratory technology program.

Academic Requirements

Eligibility for clinical practicum, as well as continuation in the MLT program, requires that students:

- Achieve a grade of "C" or better in the lab and lecture portions of all MLTC courses.
- Achieve a passing grade in all non-MLTC courses.
- Maintain a grade point average of 2.5 or above while enrolled in the MLT program.

Application to the Program

See the Associate Degree Admission Requirements on page 121. Students applying to the MLT program with math and English ACT scores less than 22 must take the Shawnee State placement examination if they have not completed mathematics and English courses at the college level. Students are also required to make an appointment with the MLT chairperson (614-355-2250) for a conference once they are notified that application to the MLT program is complete. All application materials must reach the admission office by April 1 to be

considered for the first round of admissions to the MLT program. Others will be considered on a space available basis after April 1.

Health and Physical Ability Requirements

There are specific health and physical ability requirements for the medical laboratory technology program. This information is provided at the time of application to the program.

Sample Schedule

Course No.	Course	Class Hrs.	Lab Hrs.	Credit Hrs.
FIRST QUARTER				
BIOL 151	Principles of Biology	4	2	5
CHEM 141	General Chemistry 1	3	3	4
MATH 130	Intermediate Algebra	4	0	4
MLTC 111	Medical Tech. Orientation	2	0	2
	Totals	13	5	15
SECOND QUARTER				
BIOL 162	Human Anat. and Phys.	4	2	5
CHEM 142	General Chemistry 2	3	3	4
MATH 131	College Algebra	4	0	4
MLTC 112	Basic Laboratory Skills	2	3	3
	Totals	13	8	16
THIRD QUARTER				
CHEM 143	General Chemistry 3	3	3	4
ENGL 1115	Discourse and Composition	4	0	4
MLTC 209	Hematology 1	2	6	4
MLTC 210	Hemostasis	2	2	2
MLTC 212	Clinical Chemistry 1	2	6	4
	Totals	13	17	18
FOURTH QUARTER				
BIOL 350	Microbiology	4	3	5
MLTC 202	Immunoserology	2	3	3
MLTC 207	Clinical Microbiology	3	6	5
MLTC 211	Hematology 2	2	3	3
	Totals	11	15	16
FIFTH QUARTER				
CHEM 305	Organic Chemistry 1	3	3	4
MLTC 201	Urinalysis	2	3	3
MLTC 203	Blood Banking 1	2	6	4
MLTC 204	Parasitology	1	2	1
MLTC 213	Clinical Chemistry 2	2	3	3
	Totals	10	17	15
SIXTH QUARTER				
ENGL 1125	Composition and Research	4	0	4
MLTC 215	Lab. Simulation	0	6	3
MLTC 216	Med. Lab. Sem.	1	0	1
MLTC 217	Case Studies	1	0	1
MLTC 220	Clinical Practicum	0	20	4
	Totals	6	26	13
SEVENTH QUARTER				
MLTC 221	Clinical Practicum 2	0	40	8
MLTC 225	Spec. Prob. in Med. Lab.	2	0	2
SOCI 101	Intro. to Sociology	4	0	4
SPCH 103	Public Speaking	3	0	3
	Totals	9	40	17

Please Note

Registration for courses with the MLTC prefix requires admission to the MLT program and/or the approval/signature of the MLT chairperson. Only those students who have been officially accepted or named as an alternate in the program may register for courses beginning with the MLTC prefix.

Occupational Therapy Assistant

Occupational therapy is a vital health care service that uses "occupation," meaning purposeful activity, as the basis for treatment of people with a wide variety of physical, developmental, and emotional disabilities.

Occupational therapists and occupational therapy assistants help disabled people of all ages acquire or regain the skills they need to live independent, productive, and satisfying lives. They work in hospitals, rehabilitation centers, nursing homes, public and private schools, and home health agencies.

Occupational therapy assistants work under the guidance of occupational therapists. They may choose or construct equipment that helps people to function more independently; they may carry out treatment activities for individuals or groups of patients; and they work closely with families of patients who are preparing to return home.

To become an occupational therapy assistant, you must complete an educational program. The majority of these are two-year associate degree programs like the one at Shawnee State University. Studies include basic academic subjects, human growth and development, the functioning of the human body, and occupational therapy principles and techniques. The OTA program requires two, eight-week rotations of supervised practical experience in a variety of health care settings.

After successfully completing the educational program, you are eligible to take the national certification examination for the occupational therapy assistant. Many states, including Ohio, Kentucky, and West Virginia, also require licensing by their respective states to practice occupational therapy.

Accreditation

The occupational therapy assistant program is accredited by the Accreditation Council for Occupational Therapy Education (ACOTE) of the American Occupational Therapy Association (AOTA), located at 4720 Montgomery Lane, P.O. Box 31220, Bethesda, MD 20824-1220. AOTA's phone number is (301) 652-AOTA. Graduates of the program are able to sit for the national certification examination for the occupational therapy assistant administered by the National Board for Certification in Occupational Therapy, Inc. (NBCOT); however, the NBCOT sets its own criteria for taking the exam, which may include questions on the applicant's criminal history. For more information on these limitations, you can contact NBCOT at (301) 990-7979. After successful completion of this exam, you are a certified occupational therapy assistant (COTA). Most states require licensure in order to practice; however, state licenses are usually based on the results of the NBCOT Certification Examination.

Academic Requirements

To remain enrolled in the occupational therapy assistant program, you must:

- Not receive below a "C" in any course with the OTAT prefix.
- Maintain a 2.00 GPA in all courses with the OTAT prefix.
- Obtain an overall GPA of no less than 2.00 prior to the third quarter (spring) of the first year.
- Maintain at least a 2.00 GPA during each remaining quarter.
- Successfully complete (with a "D-" or higher) BIOL 101 and 162 by the end of the third quarter (spring) of the first year.

If *any* of these criteria are not met, you are dismissed from the OTA program. Conditions for readmission to the OTA program are specified by the chairperson of the department at the time of dismissal.

Clinical Requirements

Clinical placements for the OTA program in the Portsmouth area are limited. OTAT 108, 204, and 208 (Fieldwork 1) are clinical courses requiring six to seven hours, one day per week at the assigned facility. These placements may be up to, and sometimes at distances greater than, 70 miles away from Shawnee State University. You are responsible for your own transportation to and from these facilities.

OTAT 220 and 221 (Fieldwork 2) consist of two rotations of eight weeks each. You are required to be at that facility during normal working hours (usually 40 hours per week). The OTA program assigns each student two placements. You are responsible for all expenses incurred to complete the Fieldwork 2 requirements of the OTA program. Requirements for graduation and to remain in the program are listed in the OTA Student Handbook.

You are required to have successfully completed all OTAT and other courses in the curriculum (as indicated by a minimum 2.00 GPA) prior to participating in OTAT 220 and 221. OTAT 220 and 221 must be completed 18 months following completion of other OTA courses and 2 months prior to the NBCOT certification examination date.

Sample Schedule

Course No.	Course	Class Hrs.	Lab Hrs.	Credit Hrs.
FIRST QUARTER (Fall)				
AHNR 102	Medical Terminology	2	0	2
ARTS 231	Ceramics 1	4	0	4
BIOL 101	Introduction to Biology OR	3-5	0	3-5
BIOL 151	Principles of Biology			
BUIS 101 ¹	Intro. to Comp. Info. Syst.	4	0	4
PSYC 101	Introduction to Psychology	4	0	4
	Totals	17-19	0	17-19
SECOND QUARTER (Winter)				
BIOL 162	Human Anat. and Phys.	4	3	5
OTAT 101	Intro. to Occup. Ther.	3	3	4
OTAT 102	Therapeutic Media 1	1	6	3
OTAT 108	Practicum 1 (FW1)	1	6	2
PSYC 151	Hum. Growth and Devel.	4	0	4
	Totals	13	18	18
THIRD QUARTER (Spring)				
ENGL 111S	Discourse and Comp.	4	0	4
OTAT 103	Disease Pathology	4	0	4
OTAT 109	Applied Anat. and Kines.	1	3	2
OTAT 110	Group Dynamics	1	3	2
SOCI 101	Introduction to Sociology	4	0	4
	Totals	14	6	16

¹ Due to the high demand for BUIS 101, you are strongly encouraged to take this course early in the program..

Course No.	Course	Class Hours	Lab Hours	Credit Hours
FOURTH QUARTER (Summer)				
ENGL 112S	Composition and Research	4	0	4
OTAT 204	Practicum 2 (FW1)	2	6	3
OTAT 205	Therapeutic Media 2	1	6	3
OTAT 210	OTA in Phys. Dysfunction	4	4	5
	Totals	11	16	15
FIFTH QUARTER (Fall)				
OTAT 206	Contemp. Media in OT	1	3	2
OTAT 208	Practicum 3 (FW1)	2	6	3
OTAT 212	OTA in Mental Health	3	3	4
PSYC/SOCI	Elective	4	0	4
	Totals	10	12	13
SIXTH QUARTER (Winter)				
EMTP 101 ¹	First Aid & CPR	2	0	2
OTAT 203	OTA in Devel. Disabilities	4	3	5
OTAT 209	OTA in Geriat. Prog. Plan.	3	3	4
OTAT 211	OTA Seminar	2	0	2
SPCH 103	Pub. Spk. and Hum. Com.	3	0	3
	Totals	14	6	16
SEVENTH QUARTER (Spring)				
OTAT 220	Clinical Application (FW2)	0	40	8
OTAT 221	Clinical Application (FW2)	0	40	8
	Totals	0	80	16

Physical Therapist Assistant

Physical therapist assistants are skilled technical health workers. They work under the supervision of physical therapists to help rehabilitate disabled persons so that they may again lead useful and productive lives. They may use heat, cold, electricity, and exercise for the treatment of patients. The program is designed over a seven-quarter sequence; four quarters include clinical practicums.

Please Note

- In order to remain in good academic standing in the physical therapist assistant program, you must receive a "C" (2.0) or better in each course included in the curriculum.
- Only those students who have been officially accepted into the program or who have received the approval of the department's chairperson may take the courses beginning with the PTAT prefix.

Accreditation

The physical therapist assistant program at Shawnee State University is accredited by the Commission on Accreditation in Physical Therapy Education.

Sample Schedule

Course No.	Course	Class Hours	Lab Hours	Credit Hours
FIRST QUARTER (Fall)				
AHNR 102	Medical Terminology	2	0	2
AHNR 103 ²	Prin. of Medical Science	3	0	3
BIOL 101	Introduction to Biology	3	0	3
ENGL 111S	Discourse and Comp.	4	0	4
PTAT 111	Prin. of Phys. Ther. Asst.	3	0	3
	Totals	15	0	15
SECOND QUARTER				
BIOL 162	Anatomy and Physiology	4	2	5
PTAT 112	PTA Procedures 1	3	6	5
PTAT 115	PT in Physical Dysfunction	3	0	3
	Totals	10	8	13
THIRD QUARTER				
BIOL 311	Prin. of Kinesiology	4	0	4
ENGL 112S	Composition and Research	4	0	4
PSYC 101	Introduction to Psychology	4	0	4
PTAT 113	PTA Procedures 2	3	6	5
PTAT 116	Neurology for PT	1	0	1
	Totals	16	6	18
FOURTH QUARTER				
EMTP 101 ³	First Aid & CPR	2	0	2
PTAT 114	Anatomy and Kinesiology	3	6	5
PTAT 216	Clinical Practicum Seminar	1	4	2
SOCI 101	Introduction to Sociology	4	0	4
SPCH 103	Pub. Spk. and Hum. Com.	3	0	3
	Totals	13	10	16
FIFTH QUARTER				
PTAT 202	PTA Procedures 3	3	6	5
PTAT 212	Clinical Practicum 1	2	12	4
PTAT 231	Rehab. Procedures 1	2	6	4
PTAT 235	PT Trends and Admin.	2	0	2
	Totals	9	24	15
SIXTH QUARTER				
PSYC 151	Human Growth and Devel.	4	0	4
PTAT 213	Clinical Practicum 2	2	12	4
PTAT 232	Rehab. Procedures 2	3	3	4
	Elective	4	0	4
	Totals	13	15	16
SEVENTH QUARTER (Spring)				
PTAT 214	Clinical Practicum 3	0	38	6
PTAT 255	PTA Seminar	2	0	2
	Totals	2	38	8

¹ Students must have current first aid and CPR certificates prior to starting clinical application (OTAT 220 and 221) spring quarter. This may be obtained either through EMTP 101, 102, HPER 227 (for CPR only), or at another agency.

² PSCI 105 may be substituted.

³ Students must have a current first aid card prior to their first clinical experience. EMTP 101 is not required if the student has a current first aid card. This can be obtained either through EMTP 101, HPER 227, or another agency.

Radiologic Technology

The radiologic technology curriculum prepares students for careers as radiographers, who work under the supervision of medical radiologists or physicians in hospital radiology departments, clinics, commercial x-ray laboratories, or doctors' offices. The responsibility of the radiographer is to produce a radiographic (x-ray) image of the highest diagnostic quality of any designated area of the human body. It is from this image that the radiologist makes his or her interpretations.

Curriculum for this program covers eight academic quarters. The first four academic quarters are designed to provide you with mathematics, basic science, general education courses, supporting technical courses, clinical education, and specialized courses in radiography. The second year of the program consists of additional clinical education scheduled in affiliated hospitals along with advanced radiologic technology courses.

Experience in the radiology departments of the affiliated hospitals provides opportunity for the practical application of knowledge learned in the classroom. This experience in the hospital is a vital part of the program, since it enables you to assist in the handling of sick and injured patients as they undergo a wide variety of radiographic examinations.

Upon satisfactory completion of the course requirements, you are awarded the associate in applied science degree and are eligible to apply for examination by the American Registry of Radiologic Technologists.

Accreditation

The radiologic technology program at Shawnee State University is fully accredited by the Joint Review Committee on Education in Radiologic Technology.

Academic Requirements

To remain in good standing in the radiologic technology program, the following three conditions must be met:

- You must not receive a grade of "F" in any of the required courses listed in the eight-quarter sequence.
- You must not receive a grade below a "C-" in any of the courses with the RDLT prefix.

- You must earn an overall grade point average of 2.0 by the end of the third quarter and maintain it throughout the remainder of the program.

If any one of these three conditions is not met, you are academically dismissed from the radiologic technology program. You may apply for readmission to the radiologic technology program the following year.

Please Note

- Only those students who have been officially accepted into the program or who have received the approval of the department's chairperson may take the courses beginning with the RDLT prefix.
- After the first quarter, all subsequent technical and science courses are closely related and, therefore, must be taken in sequential order. The basic courses (psychology, speech, etc.) may be taken at your convenience assuming all prerequisites are satisfied.
- You must have a current CPR certification or enroll in EMTA 102.

Sample Schedule

Course No.	Course	Class Hours	Lab Hours	Credit Hours
FIRST QUARTER				
BIOL 101	Introduction to Biology	3	0	3
ENGL 111S	Discourse and Comp.	4	0	4
MATH 130	Intermediate Algebra	4	0	4
RDLT 101	Radiologic Technology 1	2	6	4
	Totals	13	6	15
SECOND QUARTER				
BIOL 310	Human Anatomy	4	3	5
CHEM 121	Intro. to Gen. Chemistry 1	3	3	4
RDLT 102	Radiologic Technology 2	2	10	4
RDLT 200	Patient Care	3	2	3
	Totals	12	18	16
THIRD QUARTER				
BUIS 101	Intro. to Comp. Info. Syst.	4	0	4
ENGL 112S	Composition and Research	4	0	4
RDLT 103	Radiologic Technology 3	3	2	3
RDLT 111	Radiologic Physics	3	2	4
RDLT 211	Clinical Experience 1	0	16	2
RDLT 312	Sectional Anatomy	2	2	3
	Totals	16	22	20
FOURTH QUARTER				
RDLT 104	Radiologic Technology 4	3	2	3
RDLT 212	Clinical Experience 2	0	24	3
	Totals	3	26	6

Course No.	Course	Class Hrs.	Lab Hrs.	Credit Hrs.
FIFTH QUARTER				
RDLT 105	Radiologic Technology 5	3	0	3
RDLT 201	Radiographic Exposure	3	2	4
RDLT 213	Clinical Experience 3	0	24	3
SPCH 103	Pub. Spk. and Hum. Com.	3	0	3
	Totals	9	26	13
SIXTH QUARTER				
RDLT 106	Radiologic Technology 6	3	0	3
RDLT 112	Radiobiol. & Radia. Protect.	3	0	3
RDLT 214	Clinical Experience 4	0	24	3
PSYC 101	Introduction to Psychology	4	0	4
	Totals	10	24	13
SEVENTH QUARTER				
RDLT 107	Radiologic Technology 7	3	0	3
RDLT 113	Radiographic Processing	2	0	2
RDLT 215	Clinical Experience 5	0	24	3
SOCI 101	Introduction to Sociology	4	0	4
	Commun./Leader. Elective	3-4	0	3-4
	Totals	12-13	24	15-16
EIGHTH QUARTER				
RDLT 108	Radiologic Technology 8	2	0	2
RDLT 216	Clinical Experience 6	0	32	4
	Totals	2	32	6

Respiratory Therapy

Respiratory therapy is an allied health specialty, whose practitioners are employed, under medical direction, to provide treatment, management, diagnostic evaluation, and care to patients with deficiencies or abnormalities associated with the process of breathing.

Respiratory therapists work side-by-side with physicians, nurses, and other health care team members to treat patients ranging in age from premature infants to the elderly. Their duties vary from the administration of oxygen, humidity, and aerosols and the drainage of lung secretions, to the use of technologically sophisticated monitoring devices and treatment techniques in order to assure the survival of patients with life threatening conditions such as head or chest trauma.

Some practitioners choose to spend the majority of their time working in diagnostic laboratories, where they assist in the evaluation of the type and extent of a patient's pulmonary dysfunction and evaluate the effectiveness of the patient's current therapy. Other practitioners may choose to work in specialized areas of respiratory care, including education, management, home care, sales, research, and specialized

areas of diagnostic or patient care such as cardiovascular diagnostics or care of infants and children.

Certification

The graduate of the respiratory therapy program is awarded the associate of applied science degree and is eligible to sit for the examinations of the National Board for Respiratory Care. Successful completion of the "entry-level" examination of the NBRC results in the student being awarded the CRTT (Certified Respiratory Therapy Technician) credential. After successful completion of the "entry-level" examination, graduates of this program are eligible to take the "advanced practitioner" examination of the NBRC. Successful completion of that examination results in the student being awarded the RRT (Registered Respiratory Therapist) credential by the NBRC. Successful completion of the entry-level examination also results in graduates being eligible for a license to practice in any state currently having a licensure law.

Accreditation

In 1980 the Ohio Board of Regents approved the creation of this program of study, leading to the associate of applied science degree at Shawnee State University. The respiratory therapy program at Shawnee State is fully accredited by the Joint Review Committee for Respiratory Therapy Education and the Commission on Accreditation of Allied Health Education Programs.

Employment Opportunities

Because of the rapid growth of the profession since its inception in the late 1940's, many medical institutions have found that their need for trained respiratory therapy practitioners has exceeded supply. In addition, many clinics, nursing homes, and home care programs are realizing the potential benefits of having a trained respiratory care practitioner on staff. These needs, coupled with the ever-increasing number of cardiovascular disorders being diagnosed, should continue to assure that individuals who enter this profession will enjoy good career opportunities.

¹ Communication/Leadership Electives: Any English course 1155 or higher, PSYC 400 Abnormal Psychology, PSYC 375 Educational Psychology, PSYC 273 Human Adjustment, PSYC 151 Human Growth and Development, BUMG 101 Introduction to Business, BUMG 210 Management Concepts, BUMG 235 Personnel Management, BUMG 240 Labor Relations, BUMG 242 Business Communications

Academic Requirements

To remain in good standing in the respiratory therapy program, the following three conditions must be met:

- You must not receive a grade of "F" in any of the required courses listed in the curriculum.
- You must not receive a grade below a "C-" in any course with the RPTT prefix.
- You must earn an overall grade point average of 2.00 by the end of the third quarter and maintain it throughout the remainder of the program.

Failure to meet any one of the three stated conditions results in dismissal from the respiratory therapy program. You may apply for readmission to the respiratory therapy program the following year after you have successfully completed the required remedial work as detailed by the chairperson of the department at the time of dismissal.

Please Note

- Only those students who have been officially accepted into the respiratory therapy program or have received the approval of the department's chairperson may take courses beginning with the RPTT prefix.
- After the first quarter, all subsequent technical courses are closely related and, therefore, must be taken in sequential order.

Sample Schedule

Course No.	Course	Class Hrs.	Lab Hrs.	Credit Hrs.
FIRST QUARTER				
AHNR 102	Medical Terminology	2	0	2
BIOL 151	Introduction to Biology	3	3	4
CHEM 121	Intro. to Gen. Chemistry 1	3	3	4
RPTT 102	Card./Renal Anat. & Phys.	5	0	5
SPCH 103	Pub. Spk. and Hum. Com.	3	0	3
	Totals	16	6	18
SECOND QUARTER				
BIOL 162	Human Anat. & Phys.	4	3	5

MATH 130	Intermediate Algebra	4	0	4
RPTT 101	Basic Patient Care	2	3	3
RPTT 110	Medical Gas Therapy	3	3	4
RPTT 115	Clinical Application 1	0	8	1
	Totals	13	17	17

THIRD QUARTER

ENGL 111S	Discourse & Composition	4	0	4
RPTT 120	Perioperative Care	3	3	4
RPTT 121	Airway Management	1	3	2
RPTT 125	Clinical Application 2	0	8	1
RPTT 131	Pulmonary Function Test.	2	0	2
RPTT 200	Pharmacology	3	0	3
	Totals	13	14	16

FOURTH QUARTER

BIOL 350	Microbiology	4	3	5
RPTT 130	Ped. and Neon. Res. Care	4	0	4
RPTT 132	Art. Blood Gas/Acid-Base	1	0	1
RPTT 133	Laboratory Procedures	0	3	1
RPTT 135	Clinical Application 3	0	16	2
RPTT 202	Pathophysiology	3	0	3
	Totals	12	22	16

FIFTH QUARTER

ENGL 112S	Composition and Research	4	0	4
RPTT 201	Continuous Mech. Vent.	5	3	6
RPTT 205	Clinical Application 4	0	16	2
	General Studies Elective	4	0	4
	Totals	13	19	16

SIXTH QUARTER

RPTT 210	Critical Care	3	0	3
RPTT 211	Adv. Cardio. Assess.	1	0	1
RPTT 212	Pul. Rehab. & Home Care	1	0	1
RPTT 213	Department Management	1	0	1
RPTT 215	Clinical Application 5	0	24	3
	General Studies Elective	4	0	4
	Totals	10	24	13

SEVENTH QUARTER

RPTT 220	Seminar	4	0	4
RPTT 225	Clinical Application 6	0	40	8
	Totals	4	40	12

New Program Proposals

New academic programs in health sciences are currently in the approval process. Until final approval from the Ohio Board of Regents is received, students are not permitted to enroll in these programs. However, if you are interested in a bachelor's degree program in cardiopulmonary care, nursing, or radiological sciences, or an associate degree in health information management, please contact the department chairs. They can advise you on the progress of the proposal and the possible implementation date.

¹ General Studies Electives should be selected from the following approved list: ANTH 201 Introduction to Anthropology (4), any English course not currently required greater than ENGL 115S, PHIL 102 Introduction to Logic (4), PSYC 101 Introduction to Psychology (4), SOCI 101 Introduction to Sociology (4). Other communication or social science courses may be accepted, with the approval of the chairperson.

Bachelor of Science in Cardiopulmonary Care

The addition of this baccalaureate degree will allow for more experiences in the current scope of respiratory care as well as training in the newer, more diversified skills required of the respiratory care practitioner. Students completing the first two years of this program may be eligible for an associate degree in respiratory therapy and to sit for the Certified Respiratory Therapy Technician (CRTT) national exam.

For additional information, please contact Don Thomas, Chair, Department of Respiratory Therapy, (614) 355-2235.

Bachelor of Science in Nursing

This proposed program has received preliminary university approval and the final proposal is expected to be completed this academic year. This baccalaureate degree program will be attractive to the traditional student by virtue of its flexibility. Because it is a completion program, students will be able to sit for the NCLEX-RN licensure exam after completing the associate degree nursing requirements.

For additional information, please contact Dr. Mary Ann Lubno, Chair, Department of Nursing, (614) 355-2249.

Bachelor of Science in Radiological Sciences

A preliminary proposal for this baccalaureate degree program received approval from the University Senate, and the final proposal is currently being written. Students may choose to exit after the first two years of this program and will be eligible for national certification by the American Registry of Radiologic Technologists. The junior and senior level courses will provide students, as well as associate degree graduates, opportunities to pursue a baccalaureate degree in the radiological sciences. During the junior and senior years, students may choose to specialize in several areas of radiological sciences such as computed tomography, magnetic resonance imaging, or health management.

Additional information may be obtained from the chairperson of the Department of Radiologic Technology, William Sykes, room 202 in the Health Sciences Building or at (614) 355-2253 or (614) 355-2210.

Associate of Applied Science in Health Information Management

This associate degree program in Health Information Management (formerly titled "Medical Records Technology") will address the identified needs of employers for Accredited Records Technicians (ART). Students completing this AAS degree may elect to pursue a baccalaureate degree in health management at Shawnee State, thereby combining specialized administrative management skills with the technical skills of the associate degree program. This program will be designed to offer admission with advanced standing to high school graduates who have successfully completed high school level health information management programs.

For additional information, please contact Dr. James R. Kadel, Dean, College of Professional Studies, (614) 355-2216, or Dr. Margaret Christensen, Coordinator, Health Management Program, (614) 355-2605.

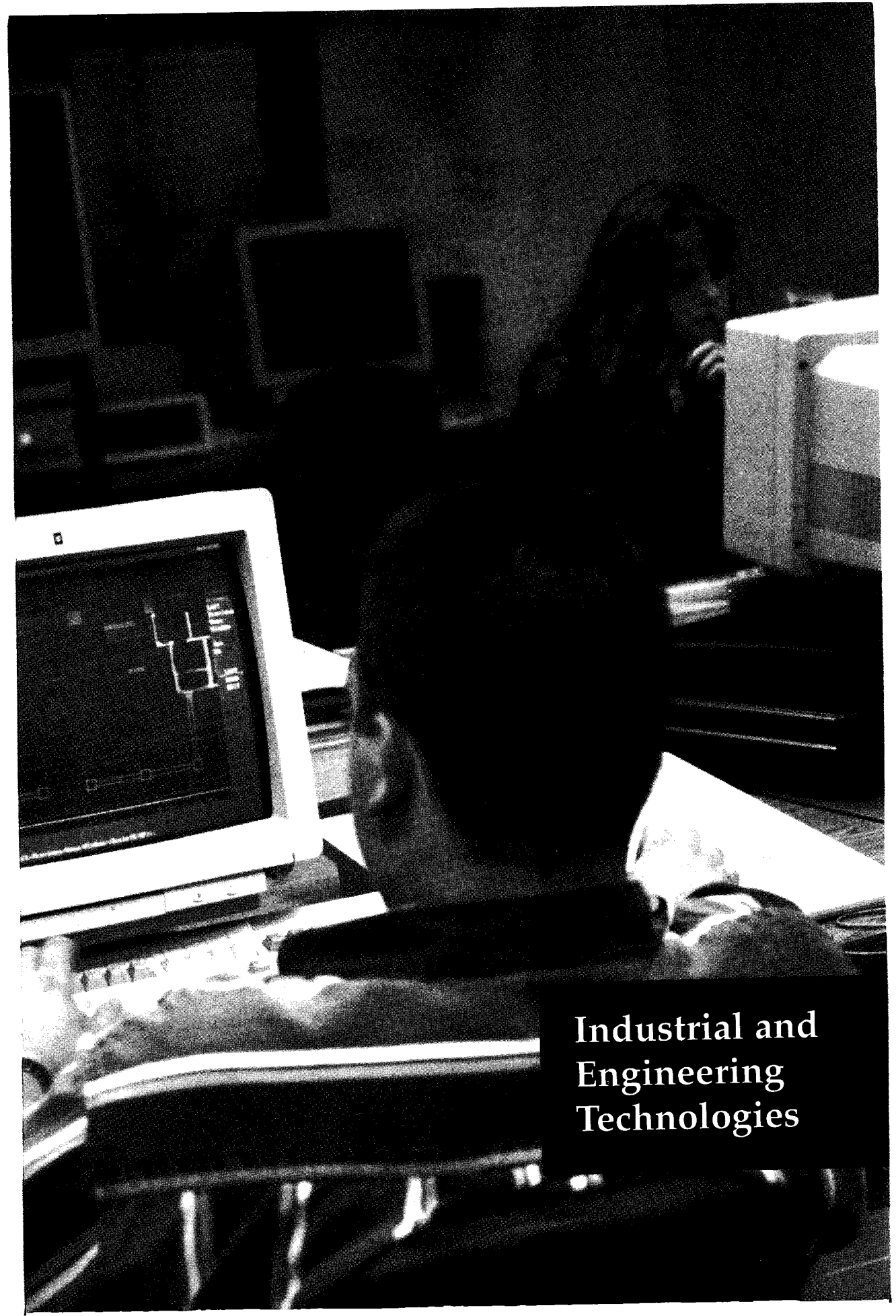

**Industrial and
Engineering
Technologies**

Industrial and Engineering Technologies

The Department of Industrial and Engineering Technologies provides you with the opportunity to develop the technical expertise, scientific knowledge, job skills, and work ethics that prepare you for entry into the social-industrial environment. Our programs provide both theory and practical training, being responsive to technological change and the industrial community while stimulating analytical thinking and establishing a foundation for further education and learning.

The Department:

- Develops curricula that create an understanding of the practical and scientific bases of selected engineering technologies and modifies curricula and teaching methods in response to technological advancement and change.
- Encourages the development of sound work ethics and a spirit of cooperation and excellence.
- Provides cooperative educational services.
- Seeks and encourages participation from the business and industrial community.
- Promotes occupational and educational opportunities for all graduates.

Your professional education is our primary goal, and the quality of your success provides the ultimate evaluation of how well we are meeting our goal.

For More Information

James R. Kadel, M.B.A., D.D.S., Dean, College of Professional Studies

Cindy Hopkins, Secretary

Dept. of Industrial and Engineering Technologies
Shawnee State University

940 Second Street

Portsmouth, Ohio 45662-4344

Phone: (614) 355-2224

Fax: [614] 355-2546

E-mail: chopkins@shawnee.edu

Degrees in Industrial and Engineering Technologies

Bachelor of Science

Computer Engineering Technology
Environmental Engineering Technology
Plastics Engineering Technology

Associate of Applied Science

Optional concentration in robotics available with each degree

Computer Aided Drafting and Design
Electromechanical Engineering Technology
Instrumentation and Control Engineering Technology
Plastics Engineering Technology

Associate of Individualized Studies

See page 103 of the current catalog for description.

Certificate

Computer Aided Drafting and Design (CADD)
Computer Technology
Plastics Engineering Technology

Industrial and Engineering Technology Programs at Shawnee State

The term "engineering technology" is described by the Accreditation Board for Engineering and Technology as follows:

"Engineering technology is that part of the technological field which requires the application of scientific and engineering knowledge and methods combined with technical skills in support of engineering activities: it lies in the occupational spectrum between the craftsman and the engineer at the end of the spectrum closest to the engineer."

This description reflects the common understanding among people in engineering and related professions that the engineering technologist is a distinct type of professional whose main concern and interest is with existing operation, maintenance, and management of products and processes. Technologists are finding increasing acceptance in positions formerly filled by engineers in such fields as sales, manufacturing, field service, and process engineering.

The term "industrial technology" is described by the National Association of Industrial Technology as:

"The field of study designed to prepare technical and/or technical management-oriented professionals for employment in business, industry, and government."

Industrial technology degree programs and professionals in industrial technology careers typically are involved with the following:

- The application of theories, concepts, and principles found in the humanities and the social and behavioral sciences, including a thorough grounding in communication skills.
- The understanding of the theories and the ability to apply the principles and concepts of mathematics and science and the application of computer fundamentals.
- The application of concepts derived from, and current skills developed in, a variety of technical and related disciplines which may include, but is not limited to, materials and production processes, industrial management and human relations, marketing, communications, electronics, and graphics.
- The completion of a field of specialization, for example, electronic data processing, computer aided design, computer integrated manufacturing, manufacturing, construction, energy, polymers, printing, safety, or transportation.

The programs offered by the Department of Industrial and Engineering Technologies provide the opportunity for graduates to enter careers in the most modern, high-demand segments of industry. All of the programs offer career-oriented, technical instruction grounded in a strong base of science and mathematics. If you are interested in these programs, you should prepare yourself by taking mathematics and science courses in high school. If you did not take mathematics and science courses in high school, you are advised to take advantage of the developmental courses available at Shawnee State, preferably during the summer before starting fall quarter. The University administers mathematics and English assessment tests in order to place each student in appropriate courses.

Articulation from Shawnee State's associate degree programs or other colleges' associate degree programs in technology into the junior year of our B.S. programs is possible. If you are interested in this option, you should see your faculty advisor for details.

Students in the B.S. degree programs in engineering technology are required to complete all courses in the University's general education program. In addition, the Department requires that all B.S. degree candidates take a core curriculum of courses in mathematics, physics, computer programming, and engineering technology sciences.

Pass/No-Credit Policy

Students in the Department of Industrial and Engineering Technologies are not permitted to take any course in their major course of study on a pass/no-credit basis. This includes any course that is specifically identified by course number and/or course title as a requirement for your graduation.

Robotics Option

Students enrolled in the associate degree programs in computer aided drafting and design and electromechanical, instrumentation and control, and plastics engineering technology may also pursue a concentration in robotics. You must have electromechanical faculty approval and complete 15 credit hours of the following courses in numerical sequence. These courses are offered upon sufficient enrollment.

ETCO 230	Introduction to Robotics OR
ETEM 209	Robotics
ETRO 211	Robotic Interfacing
ETRO 212	Robotic Applications
ETRO 213	Robotic Maintenance/Serviceing

Bachelor Degrees

Bachelor of Science in Computer Engineering Technology

The computer engineering technology program is designed for the student who wishes to pursue a career as a computing professional and who desires a challenging curriculum which offers an wholistic approach to computing. Shawnee State's program maintains a balance between computer software and hardware by blending the most critical courses from computer science with those from electrical engineering technology.

The program also balances computing theory with application by offering rigorous courses, based on the most recent ACM/IEEE computer engineering technology curricula guidelines, and adding to each of these courses an applied lab component. These labs encourage the application of theoretical knowledge to real-world projects which involve software applications, microprocessor-based systems, and computer networks.

The overall breadth and depth of the program prepares graduates to apply computing-based solutions to problems in industry, business, and medicine. In addition, their skills help them expand the frontiers of society by enabling those in the arts and sciences to attain greater levels of achievement in science, literature, art, music, and philosophy through appropriately applied computing technologies.

Careers available to graduates of the computer engineering technology program include:

- Software application developer
- Hardware engineer
- Software engineer
- Local area network specialist
- Data communications specialist
- Digital system designer
- Applied research and development engineer

Degree Requirements

General Education Program	36 Hours
<i>The General Education Program is composed of 48 credit hours of which 16 hours may be satisfied by computer engineering technology curriculum requirements. Further information is listed on page 55 of the current catalog or can be obtained from the dean's office.</i>	
Mathematics/Science Courses	36 Hours
Drafting/CADD Courses	8 Hours
Electricity and Electronics Courses	26 Hours
Computer Technology Courses	82 Hours
Engineering Tech. Mgt. Courses	9 Hours
Total Hours Required	197 Hours

Mathematics/Science Courses (36 Hours)

Course No.	Course	Cr. Hrs.
MATH 130	Intermediate Algebra	4
MATH 131	College Algebra	4
MATH 132	Trig. & Analytic Geometry	4
MATH 201	Calculus 1	4
MATH 202	Calculus 2	4

MATH	Elective ¹ Select one of the following: MATH 203, MATH 220, MATH 230, MATH 301, MATH 440.	4
PHYS 211	Calculus-Based Physics 1	4
PHYS 212	Calculus-Based Physics 2	4
PHYS 213	Calculus-Based Physics 3	4

Drafting/CADD Courses (8 Hours)

ETCA 101	Introduction to CADD	3
ELEG 110	Engineering Drawing 1	3
ELEM 130	Electromechanical Drawing	2

Electricity and Electronics Courses (26 Hours)

ELEC 361	Advanced Circuit Analysis 1	3
ELEC 362	Advanced Circuit Analysis 2	3
ELEM 111	Electrical Fundamentals 1 (DC)	4
ELEM 112	Electrical Fundamentals 2 (AC)	4
ELEM 121	Electronics 1	3
ELEM 122	Electronics 2	3
ELEM 211	Electronic Logic Circuits 1	3
ELEM 212	Electronic Logic Circuits 2	3

Computer Technology Courses (82 Hours)

ETCO 110	Computer Software and DOS	2
ETCO 115	Computer Program. for Tech.	3
ELEC 102	Structured Programming w/C	3
ELEC 103	Data Structures with C	3
ELEC 211	Assembly Lang. Program. 1	3
ELEC 212	Assembly Lang. Program. 2	3
ELEC 241	Microprocessor Circuits 1	3
ELEC 242	Microprocessor Circuits 2	3
ELEC 250	Comp. Sys. Integ. w/Novell	3
ELEC 275	Systems Programming	3
ELEC 280	Applications Programming w/C	3
ELEC 315	Computer Architecture 1	3
ELEC 320	Embedded Systems	3
ELEC 351	Networking and Comm. 1	3
ELEC 352	Networking and Comm. 2	3
ELEC 371	Realtime Operating Systems 1	3
ELEC 372	Realtime Operating Systems 2	3
ELEC 373	Adv. Operating Sys. w/UNIX	3
ELEC 421	Digital Control Systems 1	3
ELEC 422	Digital Control Systems 2	3
ELEC 430	Database Systems	3
ELEC 477	Concurrency	3
ELEC 480	Compiler Design and Implemen.	3
ELEC 483	Software Engineering	3
ELEC 491	Design Laboratory 1	4
ELEC 492	Design Laboratory 2	4
ELEC 495	Topics in Computing	3

Engineering Technology Management Courses (9 Hours)

ENGL 121	Technical Writing	3
	Electives Select two of the following: ETCO 210, ETCO 225, ETEC 355, ETPL 320.	6

¹ Completion of these mathematics courses qualifies you for a minor in mathematical sciences. Consult your advisor and the chair of the Department of Mathematical Sciences for further information.

Bachelor of Science in Environmental Engineering Technology

The environmental engineering technology program prepares graduates for responsible operations, maintenance, and management positions in a wide variety of industrial, municipal, recreational, and regulatory corporations or agencies. Those graduates who also earn licensure in a specific division of environmental engineering technologies are better prepared for management/supervisory positions in their environmental specialties.

Graduates of our program have the advantage of understanding the biological, chemical, and physical aspects of environmental engineering, along with the mechanical, electrical, and computer equipment required for waste processing.

The bachelor of science in environmental engineering technology helps the student develop a concern for the environment, the very life-stream of our existence. This concern, coupled with excellent communication skills, gives the graduate the edge needed to meet the environmental challenges of the 90s and into the 21st century.

According to the U.S. Department of Labor, Bureau of Labor Statistics, environmental engineering technologists are employed in almost every industry. Employment is expected to grow by 32%, continuing to grow faster than average and significantly increasing its share of total employment by 2005.

Degree Requirements

General Education Program 36 Hours

The General Education Program is composed of 48 credit hours of which 12 hours are satisfied by the required mathematics/science courses below. Further information is listed on page 55 of the current catalog or can be obtained from the dean's office.

Mathematics Courses	16 Hours
Natural Sciences Courses	38 Hours
Engineering Technology Courses	30 Hours
Environmental Eng. Tech. Courses	58 Hours
Synthesis	9 Hours
Track Requirement	15 Hours
Total Hours Required	202 Hours

Mathematics Courses (16 Hours)

Course No.	Course	Cr. Hrs.
MATH 131	Algebra 2	4
MATH 132	Trig. & Analytic Geometry	4
MATH 201	Calculus 1	4
MATH 250	Statistics OR	4
MATH 202	Calculus 2	

Natural Sciences Courses (38 Hours)

BIOL 151	Principles of Biology	5
BIOL 350	Microbiology	5
CHEM 141	General Chemistry 1	4
CHEM 142	General Chemistry 2	4
CHEM 200	Intro. to Organic Chemistry	4
GEOG 311	Air Pollution	4
GEOG 112	Environmental Geology	4
PHYS 201	Physics 1 (Mechanics) OR	4
ETCO 202	Statics & Strengths of Materials	
PHYS 203	Physics 2 (Heat, Light, & Sound)	4

Engineering Technology Courses (30 Hours)

ETCO 110	Computer Software and DOS	2
ETCO 115	Computer Program. for Tech.	3
ETCO 210	Occup. Safety and Hlth. Mgt.	3
ETCO 220	Hydraulics and Pneumatics	3
ETCO 225	Industrial Management	3
ETEG 105	Blue Print Reading	2
ETEG 110	Engineering Drawing	3
ETEM 110	Intro. to Electricity/Electronics	4
ETEM 115	Electromechanical Devices	4
ETIN 111	Industrial Electronics	3

Environmental Eng. Tech. Courses (58 Hours)

ETEV 110	Intro. to Environ. Eng. & Reg.	3
ETEV 120	Laboratory Techniques	4
ETEV 130	Water Treatment Techniques	3
ETEV 210	Wastewater Treat. Techniques	3
ETEV 220	Hazardous Waste	3
ETEV 230	Solid Waste Reduction	3
ETEV 240	Industrial Waste Treatment	3
ETEV 250	Fluid Mechanics	3
ETEV 260	Automation for Environ. Tech.	3
ETEV 270	Toxicology	3
ETEV 290	Summer Cooperative Ed. 1	4
ETEV 310	Thermodynamics	3
ETEV 390	Summer Cooperative Ed. 2	4
ETEV 410	Groundwater Hydrology	3
ETEV 420	Intro. to Geog. Info. Systems	3
ETEV 430	Stat. Sampling & Control	3
ETEV 440	Environmental Regulations 2	3
ETEV 480	OSHA Industrial 40 HR	4

Synthesis (9 Hours)

ENGL 121	Technical Writing	3
ETEM 220	Technical Presentations	2
ETCO 490S	Senior Seminar	3

Track Requirement (15 Hours)

TRACK A: HAZARDOUS MANAGEMENT

ETEV 345	Mgt. of Hazardous Material	3
ETEV 355	Hzrd. Mtrl. Spill Response	3
ETEV 365	Ship. & Handling Hzrd. Mtrl.	3
ETEV 435	Mon. & Con. of Poll. Sources	3
ETEV 445	Hazardous Site Remediation	3

OR

TRACK B: WASTE TREATMENT TECHNICIAN

Course No.	Course	Cr. Hrs.
ETEV 315	Water Treatment 2	3
ETEV 325	Wastewater Treatment 2	3
ETEV 335	Air Pollution 2	3
ETEV 415	Infect. Waste/Comm. Diseases	3
ETEV 425	Solid Waste Disposal 2	3

Bachelor of Science in Plastics Engineering Technology

Products made by the plastics industry range from simple articles like bottles and cups to highly intricate molded parts for the automotive, electronics, and medical products industries. Their production requires knowledgeable technologists who can design a product, select the best plastic for that product, design a mold, and establish the optimum operating conditions for the machines that are used to mold the product. The plastics engineering technology program prepares you to become a member of the team that accomplishes these objectives.

The program emphasizes plastics processing operations and includes significant components in the areas of materials, mold design, and production methods. Graduates of the program are prepared to assume an entry-level management position in a plastics production environment. Typical job titles are process engineer, project engineer, and production manager.

Degree Requirements

Additional General Ed. Program	32 Hours
<i>The General Education Program is composed of 48 credit hours of which 16 hours are satisfied by the required mathematics/science courses below. Further information is listed on page 55 of the current catalog or can be obtained from the dean's office.</i>	
Engineering Technology Courses	33 Hours
Mathematics/Science Courses	40 Hours
Support Courses	13 Hours
Plastics Engineering Tech. Courses	81 Hours
Total Hours Required	199 Hours

Engineering Technology Courses (33 Hours)

Course No.	Course	Cr. Hrs.
ETCO 110	Computer Software and DOS	2
ETCO 115	Computer Program. for Tech.	3
ETCO 202	Statics & Strength of Materials	4

ETCO 210	Occup. Safety and Hlth. Mgt.	3
ETCO 220	Hydraulics and Pneumatics	3
ETCO 225	Industrial Management	3
ETCO 230	Introduction to Robotics	3
ETEG 110	Engineering Drawing 1	3
ETEM 110	Intro. to Electricity/Electronics	4
ETCA 120	Introduction to CADKEY	3
ETXX ---	Elective (See Advisor)	3

Mathematics/Science Courses (40 Hours)

CHEM 121	Intro. to General Chemistry 1	4
CHEM 122	Intro. to General Chemistry 2	4
CHEM 200	Intro. to Organic Chemistry 1	4
MATH ---	Elective (See Advisor)	4
MATH 130	Intermediate Algebra	4
MATH 131	College Algebra	4
MATH 132	Trig. & Analytic Geometry	4
MATH 201	Calculus 1	4
PHYS 201	Physics 1 (Mechanics)	4
PHYS 203	Physics 3 (Energy)	4

Support Courses (13 Hours)

ECON 102	Principles of Microeconomics	4
ENGL 121	Technical Writing	3
SPCH 103	Pub. Spk. and Hum. Comm.	3
	Technical Electives (See Advisor)	3

Plastics Engineering Tech. Courses (81 Hours)

Processing		
ETPL 100	Plastics Manufacturing	3
ETPL 200	Injection Molding	4
ETPL 205	Extrusion/Blow Molding	4
ETPL 210	Thermoforming/Finishing	4
ETPL 215	Thermosetting Processes	4
ETPL 450	Advanced Processing 1	4
ETPL 455	Advanced Processing 2	4
Management/Supervision		
ETPL 300	Plastics in Society	2
ETPL 310	Plant Layout and Mat. Hand.	3
ETPL 320	Production Cost Analysis	3
ETPL 440	Advanced Manufac. Tech.	3
Materials		
ETPL 230	Properties of Poly. Materials	4
ETPL 240	Testing of Plastics	3
ETPL 330	Material Science	3
ETPL 460	Composites	3
Statistics		
ETPL 400	Statis. Proc./Quality Control 1	4
ETPL 405	Statis. Proc./Quality Control 2	4
ETPL 410	Applied Statistical Experimen.	4
Design/Fabrication		
ETMA 140	Machine Tools	3
ETPL 420	Plastics Part Design	3
ETPL 425	Mold Design and Analysis 1	4
ETPL 430	Mold Design and Analysis 2	4
ETPL 470	Senior Project	4

Associate Degrees

Associate of Applied Science in Computer Aided Design

The advent of computer aided design is one of the most significant developments in the drafting area. Not only has CADD revolutionized the way in which drawings are produced, but when coupled with computer aided machining (CAM), the entire manufacturing process is bound together and integrated.

Shawnee State's CADD department uses industry standard hardware and software in all classes. Unless otherwise stated, all classes utilize the latest release of AutoCAD®, which holds over 74% of the PC/CADD market.

The demand for CADD operators is high and is expected to increase rapidly through the 1990s. Positions for CADD operators exist in:

- | | |
|-----------------------|------------------|
| Aerospace | Med. equip. mfg. |
| Architecture | Packaging |
| Automotive industries | Petroleum |
| Building/construction | Piping |
| Civil engineering | Plastics |
| Defense | Tool design |
| Electronics | Transportation |
| Foundry | Utilities |
| Machining | Welding |

Students graduating from the program expect occupations as, for example, CADD operators, draftspersons, engineering designers, detailers, and technical illustrators.

CADD Sequence

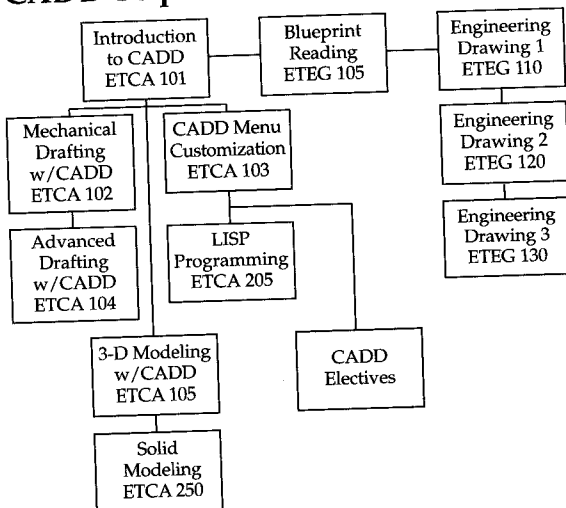

Suggested Technical Electives

Course No.	Course	Class Hrs.	Lab Hrs.	Credit Hrs.
BUIS 201	C Language	2	3	3
ETCO 202	Stat. and Strength of Mat.	3	3	4
ETEM 111	Electrical Fund. 1 (DC)	2	3	3
ETIN 120	Processing Instrumen.	3	3	4
ETPL 100	Plastics Manufacturing	2	3	3

CADD Electives *May be used as technical electives.*

ETCA 120	Intro. to CADKEY®	2	3	3
ETCA 150	Comp. Aid. Machining	2	3	3
ETCA 202	Piping Draw. w/ CADD	2	3	3
ETCA 203	Wild. Prt. Des. w/CADD	2	3	3
ETCA 204	Cst.&Mld. Des.w/CADD	2	3	3
ETCA 230	Render. and Animation	2	3	3
ETCA 285	Spec. Top. in CADD	?	?	?
ETEG 285	Spec. Top. in Eng. Drw.	?	?	?

Sample Schedule

Course No.	Course	Class Hrs.	Lab Hrs.	Credit Hrs.
FIRST QUARTER (Fall)				
ENGL111S	Discourse and Comp.	4	0	4
ETCA 101	Introduction to CADD	2	3	3
ETCO 110	Comp. Software and DOS	2	0	2
ETCO 115	Comp. Prog. for Tech.	2	3	3
ETEG 110	Engineering Draw. 1	2	3	3
ETEG 105	Blueprint Reading	2	0	2
	Totals	14	9	17
SECOND QUARTER (Winter)				
ENGL 112S	Comp. and Research	4	0	4
ETCA 102	Mechan. Draft. w/CADD	2	3	3
ETCA 103	CADD Menu Custom.	2	3	3
ETEG 120	Engineering Draw. 2	2	3	3
MATH 130	Intermediate Algebra	4	0	4
	Totals	14	9	17
THIRD QUARTER (Spring)				
ENGL 121	Technical Writing	3	0	3
ETCA 104	Advanced Draft. w/CADD	2	3	3
ETCA 105	3-D Model. w/CADD	2	3	3
ETEG 130	Engineering Drawing 3	2	3	3
MATH 131	College Algebra	4	0	4
	Totals	13	9	16
FOURTH QUARTER (Fall)				
ETCA 205	LISP Programming	2	3	3
ETCA	CADD Elective	2	3	3
ETCO 210	Occ. Safety & Hlth. Mgt.	3	0	3
ETMA 140	Machine Tools	2	3	3
SOCI - - -	Elective (advisor approved)	4	0	4
	Totals	13	9	16
FIFTH QUARTER (Winter)				
ETCA 220	Microstation®	2	3	3
ETCO 220	Hydraulics and Pneumatics	2	3	3
MATH 132	Trig. and Analytic Geom.	4	0	4
PHYS 201	Physics 1 (Mechanics)	3	3	4
ETXX - - -	Technical Elective	2	3	3
	Totals	13	12	17
SIXTH QUARTER (Spring)				
ETCA 201	Sm. Bldg. Design w/CADD	2	3	3
ETCA 250	Solid Modeling	2	3	3
ETCA	CADD Elective	2	3	3
PHYS	PHYS Elective (choose either 202 or 203 or PSCI 1105)	3	3	4
SPCH 103	Pub. Spk. and Hum. Com.	3	0	3
	Totals	12	12	16

Associate of Applied Science in Electromechanical Engineering Technology

Modern life is very dependent on electro-mechanical technology; nearly every aspect of living is dependent on electricity. This program prepares you to become a competent electro-mechanical technician capable of working and communicating with engineers, scientists, and production personnel.

The job market is almost unlimited for graduates of our program. Examples of positions in which our graduates are employed include:

- Computer development technician
- Computer service technician
- Design technician
- Draftsman
- Electrician
- Electronic assembler
- Electronic assembly foreman
- Instrumentation technician
- Maintenance foreman

Sample Schedule

Course No.	Course	Class Hrs.	Lab Hrs.	Credit Hrs.
FIRST QUARTER				
ENGL 111S	Discourse and Comp.	4	0	4
ETCO 110	Comp. Software and DOS	2	3	2
ETEG 110	Engineering Drawing 1	2	3	3
ETEM 111	Electrical Fund. 1 (DC)	3	3	4
MATH 130	Intermediate Algebra	4	0	4
	Totals	15	9	17
SECOND QUARTER				
ENGL 112S	Composition and Research	4	0	4
ETCA 101	Introduction to CADD	2	3	3
ETEM 112	Electrical Fund. 2 (AC)	3	3	4
ETEM 115	Electromechanical Devices	2	3	4
MATH 131	College Algebra	4	0	4
	Totals	15	9	19
THIRD QUARTER				
ENGL 115S	Comp. and Literature	4	0	4
ETEM 121	Electronics 1	2	4	3
ETEM 130	Electromechanical Drawing	1	3	2
ETCO 115	Comp. Prog. for Tech.	2	3	3
MATH 132	Trig. and Analytic Geom.	4	0	4
	Totals	13	10	16
FOURTH QUARTER				
ENGL 121	Technical Writing	3	0	3
ETCO 210	Occ. Safety & Hlth. Mgt.	3	0	3
ETEM 122	Electronics 2	2	4	3
ETEM 201	Electromechanical Systems	2	3	3
MATH 201	Calculus 1	4	0	4
PHYS 201	Physics 1 (Mechanics)	3	3	4
	Totals	17	9	20
FIFTH QUARTER				
ETCO 220	Hydraulics and Pneumatics	2	3	3
ETEM 208	Automation Fundamentals	2	3	3

ETEM 209	Robotics	2	3	3
ETEM 211	Electronic Logic Circuits 1	3	3	4
SOCI 110S	Found. of Social Science	4	0	4
	Totals	13	12	17

SIXTH QUARTER

ETCO 202	Statics/Strength Materials	3	3	4
ETEM 212	Electronic Logic Circuits 2	3	3	4
ETEM 215	Electromechanical Design	1	6	3
ETEM 220	Technical Presentations	1	3	2
PHYS 203	Physics 3 (Energy)	3	3	4
	Totals	11	18	17

Associate of Applied Science in Instrumentation and Control Engineering Technology

Instrumentation is the field of science dealing with the art of measurement, control, and process manipulation. Every aspect of automation and process control is dependent on the instrumentation technician, who must calibrate equipment within the standards set by the National Institute of Standards and Technology in Washington, D.C.

Our associate degree can prepare you for many career opportunities in a rapidly-growing segment of the economy. Our graduates are capable of working and communicating with engineers, scientists, and production personnel.

With experience, the job market is almost unlimited. Our graduates are employed as:

- Electricians
- Maintenance foremen
- Process operators
- Instrument technicians
- Supervisors
- Plant engineers
- Supervisory engineers

Sample Schedule

Course No.	Course	Class Hrs.	Lab Hrs.	Credit Hrs.
FIRST QUARTER				
ETCO 110	Comp. Software and DOS	2	0	2
ETCO 115	Comp. Prog. for Tech.	2	3	3
ETEG 110	Engineering Drawing 1	2	3	3
ETEM 111	Electrical Fund. 1 (DC)	3	3	4
MATH 130	Intermediate Algebra	4	0	4
	Totals	13	9	16
SECOND QUARTER				
CHEM 121	Intro. to Gen. Chemistry 1	3	3	4
ENGL 111S	Discourse and Comp.	4	0	4
ETCA 101	Introduction to CADD	2	3	3
ETEM 112	Electrical Fund. 2 (AC)	3	3	4
MATH 131	College Algebra	4	0	4
	Totals	16	9	19

Course No.	Course	Class Hrs.	Lab Hrs.	Credit Hrs.
THIRD QUARTER				
ENGL 112S	Composition and Research	4	0	4
ETCA 202	Piping Drawings with CADD	2	3	3
ETIN 103	Industrial Electricity	2	3	3
ETIN 111	Industrial Electronics	2	3	3
ETIN 120	Processing Instrumentation	3	3	4
MATH 132	Trig. and Analytic Geom.	4	0	4
	Totals	17	12	21
FOURTH QUARTER				
ENGL 121	Technical Writing	3	0	3
ETIN 201	Instrumen. Electronics	3	3	4
ETIN 202	Prog. Controllers 1	2	5	4
ETIN 221	Instrument Fundamentals	3	3	4
MATH 201	Calculus 1	4	0	4
	Totals	15	11	19
FIFTH QUARTER				
ETEM 211	Electronic Logic Circuits 1	2	4	3
ETIN 203	Prog. Controllers 2	2	5	4
ETIN 224	Industrial Control	3	3	4
PHYS 201	Physics 1 (Mechanics)	3	3	4
SOCI 110S	Found. of Social Science	4	0	4
	Totals	14	15	19
SIXTH QUARTER				
ETCO 210	Occ. Safety & Hlth. Mgt.	3	0	3
ETCO 220	Hydraulics and Pneumatics	2	3	3
ETIN 223	Measurement Principles	3	3	4
ETIN 225	Distributive Control	3	3	4
PHYS 203	Physics 3 (Energy)	3	3	3
SPCH 103	Pub. Spk. and Hum. Com.	3	0	3
	Totals	17	12	20

Concentration in Biomedical Instrumentation

Students enrolled in instrumentation and control engineering technology may choose a concentration in biomedical instrumentation, which prepares them for a career in the health care industry.

Sample Schedule

Course No.	Course	Class Hrs.	Lab Hrs.	Credit Hrs.
FIRST QUARTER				
ENGL 111S	Discourse and Comp.	4	0	4
ETCO 110	Comp. Software and DOS	2	0	2
ETCO 115	Comp. Prog. for Tech.	2	3	3
ETEG 110	Engineering Drawing 1	2	3	3
ETEM 111	Electrical Fund. 1 (DC)	3	3	4
	Totals	13	9	16
SECOND QUARTER				
CHEM 121	Intro. to Gen. Chemistry 1	3	3	4
ENGL 112S	Composition and Research	4	0	4
ETEG 105	Blueprint Reading	2	0	2
ETEM 112	Electrical Fund. 2 (AC)	3	3	4
MATH	Elective	4	0	4
	Totals	16	6	18
THIRD QUARTER				
BIOL 101	Introduction to Biology	3	0	3
ENGL 115S	Comp. and Literature	4	0	4
ETIN 111	Industrial Electronics	2	3	3

ETIN 120	Processing Instrumentation	3	3	4
MATH	Elective	4	0	4
	Totals	16	6	18
FOURTH QUARTER				
BIOL 162	Human Anat. and Phys.	4	3	5
ENGL 121	Technical Writing	3	0	3
ETIN 201	Instrumentation Electronics	3	3	4
ETIN 252	Tech. & Dev./Elec. Trblshng.	3	3	4
MATH	Elective	4	0	4
	Totals	17	9	20
FIFTH QUARTER				
AHNR 102	Medical Terminology	2	0	2
AHNR 103	Prin. of Medical Science	3	0	3
ETIN 251	Biomedical Instrumen.	3	3	4
ETIN 253	Intern. 1 Wrk. in Hosp.	1	6	3
PHYS 201	Physics 1 (Mechanics)	3	3	4
	Totals	12	12	16
SIXTH QUARTER				
ETIN 261	Instru. for Circulatory Sys.	2	3	3
ETIN 262	Bio Voltages	2	3	3
ETIN 263	Intern. 2 Wrk. in Hosp.	1	6	3
PHYS 203	Physics 3 (Energy)	3	3	4
SPCH 103	Pub. Spk. and Hum. Com.	3	0	3
	Totals	11	15	16

Associate of Applied Science in Plastics Engineering Technology

Plastics is one of the fastest growing industries in the United States, with an economic impact exceeding \$100 billion annually and providing approximately 1.5 million jobs. As it continues its rapid growth in both sales and consumption, the plastics industry will continue to lead others in both expansion and stability.

Our associate degree program prepares you to become a valuable and integral part of the plastics field. Graduates enter positions dealing with injection molding, extrusion, blow molding, thermoforming, RIM, structural and nonstructural foams, rotomolding, supervision, industrial statistics, mold preparation, setup, quality control, production control, fabrication, and semiprofessional research and development. Positions available to the plastics technology graduate include:

- Process engineer
- Production technician
- Senior technician
- Application research technician
- Technician service representative
- Quality control technician.
- Chemical sales or technical service representative

Graduates of this associate degree program have the option of applying their two years

directly into the bachelor's program in a 2+2 fashion. This gives you the flexibility to leave at the end of two years or finish the bachelor's degree in four years.

Sample Schedule

Course No.	Course	Class Hrs.	Lab Hrs.	Credit Hrs.
FIRST QUARTER				
CHEM 121	Intro. to Gen. Chemistry 1	3	3	4
ENGL 111S	Discourse and Comp.	4	0	4
ETCO 110	Comp. Software and DOS	2	0	2
ETPL 100	Plastics Manufacturing	2	3	3
MATH 130	Intermediate Algebra	4	0	4
	Totals	15	6	17
SECOND QUARTER				
CHEM 122	Intro. to Gen. Chemistry 2	3	3	4
ENGL 112S	Composition and Research	4	0	4
ETEG 110	Engineering Drawing 1	2	3	3
ETMA 140	Machine Tools	2	3	3
MATH 131	College Algebra	4	0	4
	Totals	15	9	18
THIRD QUARTER				
CHEM 200	Intro. to Organic Chem.	3	3	4
ENGL 115S	Comp. and Literature	4	0	4
ETCA 120	Intro. to CADKEY®	2	3	3
ETPL 200	Injection Molding	3	3	4
MATH 132	Trig. & Analytical Geom.	4	0	4
	Totals	16	9	19
FOURTH QUARTER				
ETCO 115	Computer Prog. for Tech.	2	3	3
ETPL 205	Extrusion/Blow Molding	3	3	4
ETPL 230	Prop. of Polymeric Mat.	3	3	4
ETPL 240	Testing of Plastics	2	3	3
MATH 201	Calculus 1	4	0	4
	Totals	14	12	18
FIFTH QUARTER				
ENGL 121	Technical Writing	3	0	3
ETCO 225	Industrial Management	3	0	3
ETEM 110	Intro. to Electrcy./Elctrcms.	3	3	4
ETPL 210	Thermoform. and Finish.	3	3	4
PHYS 201	Physics 1 (Mechanics)	3	3	4
	Totals	15	9	18
SIXTH QUARTER				
ETCO 210	Occ. Safety & Hlth. Mgt.	3	0	3
ETCO 220	Hydraulics and Pneumatics	2	3	3
ETPL 215	Thermosetting Processes	3	3	4
PHYS 203	Physics 3 (Energy)	3	3	4
SPCH 103	Pub. Spk. & Hum. Com.	3	0	3
	Totals	14	9	17

and CADD operation. It prepares you for an occupation as a drafter or CADD operator using the latest version of AutoCAD. In this three-quarter program, you take three drafting courses and at least five courses in CADD. The remaining three electives allow you to explore other areas of technology and to specialize in an individual field of study. If you wish to further your studies after completing the certificate, you may choose to continue in the associate degree program in CADD.

Sample Schedule

Course No.	Course	Class Hrs.	Lab Hrs.	Credit Hrs.
FIRST QUARTER				
ETCA 101	Introduction to CADD	2	3	3
ETCO 110	Comp. Software and DOS	2	0	2
ETXX ---	Elect.: CADD fclty. approv.	2	3	3
ETEG 110	Engineering Drawing 1	2	3	3
ETEG 105	Blueprint Reading	2	0	2
MATH 105	Plane Geometry	4	0	4
	Totals	14	9	17
SECOND QUARTER				
ETCA 102	Mech. Draft. with CADD	2	3	3
ETCA 130	CADD Menu Custom.	2	3	3
ETEG 120	Engineering Drawing 2	2	3	3
MATH 130	Intermediate Algebra	4	0	4
ETXX ---	Elect.: CADD fclty. approv.	2	3	3
	Totals	12	12	16
THIRD QUARTER				
ETCA 104	Advanced Draft. w/CADD	2	3	3
ETCA 105	3-D Modeling with CADD	2	3	3
ETCA ---	CADD Elective	2	3	3
ETEG 130	Engineering Drawing 3	2	3	3
ETXX ---	Elect.: CADD fclty. approv.	2	3	3
	Totals	10	15	15

Plastics Engineering Technology

The one-year plastics engineering technology certificate program combines various coursework in plastic processes, production, processing, and the basic plastic science necessary for a realistic grasp of the industry.

Graduates of the program are prepared for entry into one of the largest production environments in the country. Entry-level positions include machine operator, material handler, and mold set-up assistant. Students should see their plastics faculty advisor before beginning this program.

Certificates

Computer Aided Drafting and Design Technician Program

The one-year CADD certificate program allows you to quickly develop skills in drafting

Sample Schedule

Course No.	Course	Class Hrs.	Lab Hrs.	Credit Hrs.
FIRST QUARTER				
ETCO 110	Comp. Software and DOS	2	0	2
ETCO 115	Comp. Prog. for Tech.	2	3	3
ETPL 100	Plastics Manufacturing	2	3	3
ETPL 205	Extrusion/Blow Molding	3	3	4
ETPL 300	Plastics in Society	2	0	2
	Totals	11	9	14
SECOND QUARTER				
ETCA 120	Introduction to CADKEY®	2	3	3
ETCO 225	Industrial Management	3	0	3
ELEG 110	Engineering Drawing 1	2	3	3
EITEM 110	Intro. to Electrcy./Elctrncs.	3	3	4
ETPL 210	Thermoforming/Finishing	3	3	4
	Totals	13	12	17
THIRD QUARTER				
ETCO 210	Occ. Safety & Hlth. Mgt.	3	0	3
ETCO 220	Hydraulics and Pneumatics	2	3	3
ETPL 200	Injection Molding	3	3	4
ETPL 215	Thermosetting Processes	3	3	4
SPCH 103	Pub. Spk. and Hum. Com.	3	0	3
	Totals	14	9	17

Minors

Minor in Plastics Engineering Technology

A minor in plastics engineering technology offers students in any of Shawnee State's other baccalaureate programs an opportunity to broaden their major course of study with an auxiliary focus in plastics engineering technology. The minor requires eight classes (24-25 credit hours) from the plastics engineering technology program and is designed for students in degree programs other than plastics engineering technology.

Required Courses (17 Hours)

ETCA 120	Introduction to CADKEY®
ETPL 100	Plastics Manufacturing
ETPL 240	Testing of Plastics
ETPL 300	Plastics in Society
ETPL 320	Production Cost Analysis
ETPL 330	Material Science

Elective Courses (7-8 Hours)

Two additional courses from the following list, one of which must be 300 or 400 level.

ETMA 140	Machine Tools
ETPL 200	Injection Molding
ETPL 205	Extrusion/Blow Molding

ETPL 210	Thermoforming/Finishing
ETPL 215	Thermosetting Processes
ETPL 230	Properties of Polymeric Materials
ETPL 400	Statistical Process/Quality Control 1
ETPL 405	Statistical Process/Quality Control 2
ETPL 440	Advanced Manufacturing Techniques
ETPL 450	Advanced Processing 1
ETPL 460	Composites

Minor in Computer Aided Design (25-28 Hours)

Students enrolled in any of Shawnee State's baccalaureate programs may elect to pursue a minor in computer aided design. A CAD minor provides the computer, technical, and design skills necessary to stay competitive in today's job market. Students use the latest version of AutoCAD®, which is the number one CAD software company worldwide (Darattech Inc., Cambridge, MA). The popularity of this software ensures a growing demand for proficient AutoCAD operators.

Required Courses (17 Credits)

Course No.	Course	Cr. Hrs.
ETCA 101	Introduction to CADD	3
ETCA 102	Mech. Draft. with CADD	3
ETCA 103	CADD Menu Customization	3
ETCA 105	3D Modeling with CADD	3
ELEG 105	Blueprint Reading	2
ELEG 110	Engineering Drawing 1	3

Elective Courses (8-11 Credits)

The number of credits is dependent on sequence selected. Choose from one of the following.

Sequence A		
BUAI 101	Intro. to Automated Info. Sys.	4
BUAI 103	Computer Applications	4
Sequence B		
BUIS 101	Intro. to Computer Info. Sys.	4
BUIS 103	BASIC Language	4

Sequence C		
ETCO 110	Computer Software and DOS	2
ETCO 115	Computer Program. for Tech.	3

AND, select one of the following courses (regardless of which sequence is chosen):

ETCA 104	Adv. Drafting with CADD	3
ETCA 150	Computer Aided Machining	3
ETCA 201	Small Building Design	3
ETCA 230	Rendering and Animation	3

Minor in Computer Technology

(For baccalaureate degree students)

Certificate in Computer Technology

(For nondegree students)

In the past decade, the increased power and connectivity of personal computers have increased their utility to the point where they are commonplace throughout business, industry, government, health care, and education. The computer age is not coming, but is here now.

This area of study, which leads to a minor for degree students or a certificate for nondegree students, is in keeping with Shawnee State's mission of preparing you for the changing needs of business, industry, education, and society and also the general education program which recognizes that keyboarding skills and the use of programming and applications software are considered essential communication skills.

This minor and certificate are recommended for mathematics and science majors, but any student enrolled at Shawnee State University may pursue these programs except those enrolled in associate or baccalaureate degrees which require eight or more hours of automated information systems (BUAI), business information systems (BUIS), computer engineering technology (ETEC), computer aided drafting design (ETCA), engineering technology core (ETCO), or office administration (BUOA) computer courses.

The minor and certificate are divided into four components: keyboarding, hardware and operating systems, programming languages, and applications software.

Required Courses (21 Hours)

Keyboarding

Course No.	Course	Cr. Hrs.
BUOA 108	Beg. Document Processing	4

Computer Hardware, Algorithms, and Operating Systems

BUIS 205	Bus. Data Syst. and Comm.	3
ETCA 101	Introduction to CADD	3

ETCO 110	Computer Software and DOS ¹	2
ETCO 115	Programming for Technology	3
ETEC 250	Comp. Syst. Integr. w/Novell	3
ETEC 373	Adv. Operating Syst. w/UNIX	3

Elective Courses (select three)

Programming Languages

BUIS 201	"C" Language	4
BUIS 206	Fortran 77	4
BUIS 207	PASCAL Language	4
BUIS 208	RPG II Language	4
ETEC 102	Structured Programming w/C	3
ETEC 103	Data Structures with C ²	3
ETEC 211	Assemb. Lang. Program. 1 ³	3
ETEC 212	Assemb. Lang. Program. 2 ⁴	3
ETEC 280	Applications Program. w/C ³	3

Applications Software

BUAI 103	Computer Applications	4
BUAI 310	Data Base Management	4
ETCA 105	3-D Modeling with CADD	3
ETCA 120	Introduction to CADKEY®	3
ETCA 230	Rendering and Animation	3
BUOA 215	Lotus 1-2-3	4
BUOA 217	Office Computer Applications	4
BUOA 221	Word Processing 1	4
BUOA 222	Word Processing 2	4
BUOA 230	Desktop Publishing 1	4

Hours required for completion: 30 to 33

Students enrolled in the computer technology certificate or minor program will be assigned a computer engineering technology faculty advisor in the Department of Engineering Technologies.

Pre-Engineering Curriculum

The College of Professional Studies and the College of Arts and Sciences offer a two-year pre-engineering program to students who intend to pursue a career in engineering. Designed for students who wish to transfer to a traditional engineering school, this two-year curriculum includes technical, humanities, and liberal arts courses. Pre-engineering students are enrolled in the Department of Engineering Technologies or College of Arts and Sciences and are advised by appropriate faculty. These faculty are also available to help you decide which particular branch of engineering you might wish to pursue.

¹ BUIS 101 and BUAI 101 may be substituted with the approval of the faculty advisor for this minor and certificate program.

² Prerequisites are ETEC 102 and MATH 220. Recommended for mathematics and science majors.

³ Prerequisite ETEC 103 or advisor approval.

⁴ Prerequisite ETEC 211.

While this curriculum is designed to meet the general needs of many traditional engineering institutions, you should verify any specific needs of the school and discipline of your choice. In addition, most of this coursework will satisfy scholastic requirements if you wish to pursue a degree in engineering technology or natural sciences, concentrating in physics, through Shawnee State University. Another option is an associate of science degree in individualized studies with concentrations in a number of technical disciplines.

Pre-Engineering General Course Sequence

Course No.	Course	Cr. Hrs.
FIRST YEAR		
FALL QUARTER		
CHEM 141	General Chemistry 1	4
ENGL 111S	Discourse and Composition	4
ETCO 110	Computer Software and DOS	2
ETCO 115	Comp. Program. for Tech.	3
MATH 201	Calculus 1	4
	Total	17
WINTER QUARTER		
CHEM 142	General Chemistry 2	4
ENGL 112S	Composition and Research	4
ETEC 102	Structured Programming w/C	3
MATH 202	Calculus 2	4
PSYC 101	Introduction to Psychology	4
	Total	19
SPRING QUARTER		
CHEM 143	General Chemistry 3	4
ECON 101	Principles of Economics	3
ENGL 115S	Composition and Literature	4
ETEC 103	Data Structures with C	3
MATH 203	Calculus 3	4
	Total	18
SECOND YEAR		
FALL QUARTER		
ENGL 121	Technical Writing	3
ETCA 101	Introduction to CADD	3
ETEG 110	Engineering Drawing	3
MATH 204	Calculus 4	4
PHYS 211	Calculus-Based Physics 1	4
	Total	17
WINTER QUARTER		
ENGL 225S	Civilization and Literature 1	4
MATH 301	Ordinary Differ. Equations	4
PHIL 320S	Ethics in Pub. and Priv. Life	4
PHYS 212	Calculus-Based Physics 2	4
	Total	16
SPRING QUARTER		
ENGL 226S	Civilization and Literature 2	4
PHYS 213	Calculus-Based Physics 3	4
SOCI 110S	Foundations of Social Science	3

SOCI 150	Principles of Statistics	4
SPCH 103	Pub. Speak. and Hum. Com.	3
	Total	18

Special Notes

- Students starting in an even numbered year should schedule physics in the first year and chemistry in the second. Students starting in an odd numbered year, should follow the schedule shown above.
- Some prerequisites are presumed, and remediation will be required if not met:
 - a) CHEM 141 requires high school chemistry or CHEM 121 and corequisite of MATH 130.
 - b) MATH 201 requires placement or the following sequence: MATH 099, 101, 105, 130, 131, 132. (This sequence may be entered at any point.)

New Programs

Within the next year the Department of Industrial and Engineering Technologies intends to write final proposals for associate degree exit opportunities within the currently offered baccalaureate degree programs in environmental engineering technology and in computer engineering technology.

A proposal for a new bachelor of applied science degree in CAM (Computer Aided Manufacturing) is also being developed. This will be a 2+2 degree program with the associate of applied science degree in CADD.

Students are not permitted to enroll in these degree programs until the proposals have received final approval from the Ohio Board of Regents. However, if you'd like more information, you may contact:

- Roger Diamond, CAD-CAM Technology, (614) 355-2374
- Carl Hilgarth, Computer Engineering Technology, (614) 355-2595
- Ken Warfield, Environmental Engineering Technology, (614) 355-2465



Outreach
Programs

Outreach Programs

Talent Search

Shawnee State University's Educational Talent Search program is funded through a grant from the U.S. Department of Education and serves residents of Lawrence, Pike, and Scioto Counties. The program provides services to high school students or young adults up to 27 years of age who want to pursue a college education. Participants must meet low income guidelines, as established by the U.S. Department of Education, be a potential first generation college student, or have other needs as determined by assessment.

Participants receive:

- **Educational Counseling:** ACT, SAT, PSAT test preparation workshops; information about specific colleges, universities, and other schools; assistance selecting, applying to, and enrolling in educational programs after high school; college life orientation workshops; contacts with school representatives; and assistance selecting high school classes in preparation for college.
- **Career Counseling Services:** Career exploration and planning, career interest testing and follow-up, goal setting.
- **Financial Aid Information and Assistance:** Financial aid workshops for parents and students, individual information about and assistance with applications for grants, scholarships, college work programs, and student loans.
- **Assistance with Special Needs:** Identification of support services for disabled individuals and for students who may need additional help for college or vocational success (i.e., tutoring and counseling).

The Talent Search program is located in the Trio Center on the first floor of the Commons Building, and the office is open Monday through Friday, 8:00 a.m. to 5:00 p.m. Please call (614) 355-2558 for further information.

Tech Prep Ohio South Consortium

By the end of this century, our state and national economies will need many more highly skilled technical workers. These important, good-paying jobs will require more than a high school education, but less than a four-year college degree. This means that many more young Americans will need to prepare to go to college—and particularly into the technical programs offered at their local university.

Tech Prep is a new way of doing business in our high schools and colleges. It aims at preparing more young people to enter the training pipeline for technical jobs of the future. Tech Prep high school students (1) learn college preparatory academics in applied, real-world contexts that make the content more meaningful and accessible to them; (2) develop technological literacy, including the "new basics" of computer usage; (3) in 11th and 12th grade, immerse themselves in occupational skills needed to enter and succeed in an associate degree program. Tech Prep is also designed to be flexible, enabling students to opt in or out of Tech Prep at various points in their high school experience.

At the end of high school, Tech Prep graduates are ready to choose a technical major and enter an advanced skills technical associate degree program at a university or community college. Alternatively, they can enter the world of work with an array of stronger basic and occupational skills than graduates of general education programs.

In our area, the Tech Prep Ohio South Consortium partners Shawnee State University, Ohio University Southern Campus, and local school districts with a wide array of regional business and industry partners. The Consortium, which originated in 1992 with a federal Tech Prep grant, is a dynamic initiative that continues to evolve and grow in its partnerships and its scope of programming.

As Tech Prep high school graduates enter Shawnee State University, the associate degree programs in engineering technologies and business technologies are ready to receive them. Tech Prep students have the opportunity to enhance their associate degree by completing additional courses in a related technology area, making them better prepared for tomorrow's job market.

For more information about Tech Prep contact:

Tech Prep Ohio South Consortium
Virginia Ramey, Director
Shawnee State University
940 Second Street
Portsmouth, OH 45662-4344
(614) 355-2281
Fax: [614] 355-2598

Upward Bound

Shawnee State University's Upward Bound program serves students from several Scioto County high schools. The program focuses on students who are interested in attending college but who may need an extra "push" to turn that interest into reality. Upward Bound provides academic, social, recreational, cultural, and counseling services in order to generate the skills, motivation, and self-confidence necessary for success in college.

The primary goal of the program is to prepare students for college or technical education after high school. This is completed in two phases.

The first phase is the academic year component. During this time, Upward Bound develops college study skills and provides tutoring and counseling. Also, the program meets once a month for planned educational and exciting social activities that reward the students for their efforts.

The second phase is the summer component. During the summer, the students take part in a six-week, residential program on the campus of Shawnee State University. While living in dorms, the students take interesting academic courses and enjoy fun social activities and educational travel experiences. The students have the opportunity to work, too. In other words, the student gets a taste of what college life is all about.

High school students are selected for the Shawnee State Upward Bound program if:

- They show potential for academic success in college, but lack adequate skills, motivation, or self-confidence.
- They are first generation college students, meaning that neither of their parents earned a bachelor's (four-year) degree. Other students will be considered for the program, but the majority must be first-generation college students.

- Their family income does not exceed the guidelines determined by the U.S. Department of Education. Other students will be considered for the program, but the majority must come from families whose income does not exceed the established guidelines.

For more information about the Upward Bound program, please contact our office, which is located in the Trio Center in the Commons Building. Our phone number is (614) 355-2439.

Ohio Appalachian Center for Higher Education

Another example of Shawnee State University's commitment to residents of rural Ohio is the Ohio Appalachian Center for Higher Education (OACHE). Located on the Shawnee State campus, OACHE is a consortium of the ten public colleges and universities within the 29-county Ohio Appalachian region, which is approximately one-third of the state. The mission of OACHE is to increase the level of educational attainment of residents by sponsoring access projects in member institutions and in public school districts.

OACHE operates with funds provided by the Ohio General Assembly through the Ohio Board of Regents. It is, thus, a unique model that combines the efforts of state government, higher education institutions, public school districts, and businesses to increase the college-going rate throughout this high poverty region. Traditionally this area has had a college-going rate of only half the national average.

In addition to Shawnee State University, consortium members include Belmont Technical College, Hocking Technical College, Jefferson Community College, Kent State University at Salem and East Liverpool, Muskingum Area Technical College, Ohio University, Rio Grande Community College, Southern State Community College, and Washington State Community College. The Board of Directors consists of a representative from the Ohio Board of Regents and the presidents of member institutions.

Shawnee State's President Veri initiated the formation of the consortium and served as chairman of the Board of Directors during the first five years of the project.

For more information, contact Wayne F. White, the executive director, at (614) 355-2299.

Ohio Appalachian Educational Opportunity Center

The Ohio Appalachian Educational Opportunity Center (EOC) is a federal TRIO program, funded by the U. S. Department of Education. The EOC is housed on Shawnee State's campus, is sponsored by the Ohio Appalachian Center for Higher Education, and operates throughout the 29-county Ohio Appalachian region.

The EOC is a comprehensive counseling and referral program, providing FREE academic, vocational, career, and financial aid information to eligible adults. Services include:

- Information about opportunities for post-secondary education and training
- Information and referral on precollege preparation
- Career counseling
- Assistance with college selection
- Assistance with the completion of admission forms and requirements
- Assistance with the completion of financial aid forms and applications
- Follow-up and referral to support agencies and services that may ensure completion of academic goals

EOC outreach coordinators are located on the campuses of Belmont Technical College, Hocking Technical College, Jefferson Community College, Muskingum Area Technical College, Rio Grande Community College, Southern State Community College, and Washington State Community College.

The EOC director's office is located in Shawnee State's Counseling and Career Center and can be reached by calling (614) 355-2299.

The BEARS Program

Shawnee State's BEARS program, whose title is an acronym for Beginning Early Academically Results in Success, is funded by a grant from the Ohio Appalachian Center for Higher Education. The program serves all ten school districts in Scioto County and selected schools in Pike County. Each year, BEARS staff reach out to approximately 4,200 sixth, eighth, and tenth grade students and point out the values of academic achievement and attending college. The program provides a variety of activities, including classroom presentations, an evening program (Paving the Way) for students and parents, and campus programs and visits. The emphasis of BEARS is on helping students to explore career options available to them as well as the value of adequate planning regarding careers that require a college education.

For more information about the BEARS program, contact Lois Rase, the coordinator, at (614) 355-2543.



Course Descriptions

Explanation of Prerequisites

Most learning beyond basic skills is dependent upon mastery of some prior skill or subject content. As a result, many courses at the University require the satisfaction of prerequisites prior to course enrollment. Prerequisites may be met by successful completion of the prior courses listed or by placement, via testing, into the course.

The academic division/college may withdraw a student from a course for which prerequisites have not been satisfied.

Explanation of Abbreviations

These abbreviations are found throughout the course descriptions on the following pages. In addition, it should be noted that some upper level courses are not included on these pages. Please contact your faculty advisor for further information.

Su — Summer

F — Fall

W — Winter

Sp — Spring

Preq. — Prerequisite

Coreq. — Corequisite

\$ — Indicates lab fee

Associate Degree Nursing

SPECIAL NOTE—ADNR (Associate Degree Nursing): Only students officially accepted into the nursing program or those with approval of the program director may take the courses with the ADNR prefix. All ADNR courses must be taken in sequence.

ADNR 101 Nursing 1—Fundamentals 1 (8) Introduction to the nursing process system enabling students to assist individuals to meet daily living needs. Fundamental skills and related scientific principles of nursing are presented. Laboratory practice provides the opportunity to develop beginning skills in both technical and interpersonal aspects of nursing. *F; preq. admission to ADN program; 5 lec. 9 lab; \$15.00*

ADNR 102 Nursing 2—Fundamentals 2 (8) Continuing development of basic nursing skills. A beginning study of medical-surgical nursing concepts relevant to all age groups. Emphasis on application of all components of the nursing process. *W; preq. 2.0 average or better in courses required for fall quarter of first year; 5 lec. 9 lab*

ADNR 103 Nursing 3—Nursing of Adults and Children 1 (8) Focuses on implementing the nursing process in meeting basic needs of the adult or child experiencing stressors related to safety and security, activity and rest, and sexual role satisfaction. Further development of technical skills. *Sp; preq. 2.0 average or better in courses required in winter quarter of first year; 4 lec. 12 lab*

ADNR 201 Nursing 4—OB Maternal/Newborn Nursing (5) Applies the nursing process in the study of the normal aspects of the maternal cycle and the normal newborn infant. Common recurring stressors related to the maternal/newborn cycle are presented. Skills needed to provide family-centered nursing in normal and stress situations are introduced. *F W; 6 lec. 12 lab (may be five-week course)*

ADNR 202 Nursing 5—Mental Health and Illness (5) Presents concepts of mental health and selected deviant emotional and mental responses to stress. Encourages increased self-awareness and development of beginning skills in the use of self. Application of the nursing process in providing nursing care for clients with specific behavior patterns. *F W; 6 lec. 12 lab (may be five-week course)*

ADNR 203 Nursing 6—Trends (2) Concerns of nursing—past, present, and future—are explored. Discussion of the relationship of the technical nurse to health professions and community, personal development of the individual, and legal and ethical implications for nursing practice. *F W*

ADNR 204 Nursing 7—Nursing of Adults and Children 2 (10) Applies the nursing process in caring for adults and children experiencing stressors affecting oxygen transport and fluids and electrolytes balance. *F W; 6 lec. 12 lab*

ADNR 205 Nursing 8—Nursing of Adults and Children 3 (9) Systematically applies the nursing process in caring for groups of patients. Synthesizes previous knowledge for utilization of the nursing process with adult and child clients experiencing stressors affecting nutrition and elimination. *Sp; preq. ADNR 201, 202, 203, and 204; 4 lec. 15 lab*

ADNR 211 Nursing 9—Nursing Seminar (3) A theoretical and practical approach to setting nursing priorities. Discussion of the transition from student role to graduate role as a member of the health team. *Sp*

ADNR 299 Nursing Special Topics (1-3) Individual or small-group study, under the supervision of an instructor, of topics not otherwise available to students.

Allied Health/Nursing

AHNR 100 Pre-Anatomy (4) Students are prepared for anatomy by learning medical roots, muscles, bones, body planes, and medical abbreviations. This is a special course developed primarily for all health science programs. *F W Sp*

ADNR 101 - AHNR 100

AHNR 101 - AHNR 410

- AHNR 101 Introduction to Health Technologies (2)** Introduction to the health professions, including history, responsibilities, and ethics. Includes introduction to the health science programs at Shawnee State University. Offered on demand
- AHNR 102 Medical Terminology (2)** Introduction to medical terminology commonly used in health occupations. Emphasis is placed on prefixes, suffixes, and building and analyzing medical terms. *Su F*
- AHNR 103 Principles of Medical Science (3)** Basic inorganic, organic, and biochemistry principles as applied to human physiology. Includes principles of physics and the metric system. Specifically designed for students in allied health or nursing programs. *Su F Sp; req. acceptance into one of the health science programs or permission of health science department chair*
- AHNR 199 Topics in Health Sciences (1-14)** Individual or small group study, under the supervision of an instructor, of topics otherwise not available to students.
- AHNR 285 Topics in Health Physics 1 (1-14)** Ten (10) course modules of classroom instruction focus on biological effects of radiation, radiation protection standards, regulations/ALARA, respiratory protection, radiological control and monitoring, radiation protection and measurement, atomic and nuclear properties, interaction of radiation with matter, and dosimetry.
- AHNR 286 Topics in Health Physics 2 (1-14)** A continuation of AHNR 285. Ten (10) course modules of classroom instruction focus on biological effects of radiation, radiation protection standards, regulations/ALARA, respiratory protection, radiological control and monitoring, radiation protection and measurement, atomic and nuclear properties, interaction of radiation with matter, and dosimetry.
- AHNR 299 Topics in Health Sciences (1-14)** Individual or small group study, under the supervision of an instructor, of topics not otherwise available to students.
- AHNR 310 Orientation to Health Care Systems (4)** Cross-listed as BUHE 310. A broad orientation to the health services industry. Segments of the health services industry are identified and described with historical background, functions, interrelationships, and future roles of each. Required for health management concentration
- AHNR 311 Health Record Principles (4)** Cross-listed as BUHE 311. Study of the health record, including definition, standards for content, and format. Also studied are the interactions of the health care professionals contributing to, utilizing, and analyzing health record data.
- AHNR 312 Health Care Personnel Management (4)** Cross-listed as BUHE 312. Principles of health care personnel recruitment, selection, and management. Characteristics of the professional health care worker are discussed. Legal responsibilities, collective bargaining, continuing education, and training are covered.
- AHNR 325 Instructing Adults (3)** Cross-listed as EDUC 325. Study of adult learning needs and participation patterns. Teaching styles and techniques best suited to adults are analyzed and demonstrated.
- AHNR 327 Methods of Teaching in Health and Occupations (3)** Cross-listed as EDUC 327. The subject matter and teaching methodologies of health instruction in classrooms, laboratories, and community settings are analyzed and demonstrated.
- AHNR 402 Community Health Education (3)** Cross-listed as EDUC 402. Philosophy of community health education with emphasis on historical, conceptual, and legal precepts.
- AHNR 410 Patient Care Issues in Long-Term Health Care Facilities (4)** Cross-listed as BUHE 410. An overview of the total medical and social care required for residents of long-term health care facilities. Orientation to the various aspects required of the administrator and institution to provide for the total care of the individual. Topics include pharmaceutical services, disease process and recognition, biological aging, psychology of patient care, patient assessment, care planning, and nutrition. *Su 1st 5-wk 1997, W 1997, 1998*

AHNR 411 Administration in Extended Care Facilities (4) Cross-listed as BUHE 411. The role and responsibility of management as applied to a long-term health care facility. Includes discussion of ethical practices, licensure, state and federal agency requirements, and financial management. *Su 2nd 5-wk 1997, Sp 1997, 1998*

AHNR 420 Problems in Health Care Management and Policies (4) Cross-listed as BUHE 420. A seminar course. Health care management problems are studied and recommendations offered for the resolution of those problems. It is recommended that this problems and policy course be taken as the last course in the 24-hour health management concentration.

AHNR 430 Health Care Finance and Reimbursement (4) Cross-listed as BUHE 430. Analysis of reimbursement and payment systems for health care related organizations such as acute care, extended care, managed care, and other alternative care groups. *F 1996, 1997; preq. BUAC 101 and 102 or BUAC 201; see advisor*

AHNR 451 Internship in Extended Health Care Management (6) Cross-listed as BUHE 451 and EDUC 451. Provides 400 hours of a structured and supervised professional experience within an approved extended health care organization. Students complete assigned projects and/or managerial tasks under joint supervision of a health care facility administrator and a university faculty member. *Su 10-wk, F W Sp as needed; preq. coursework completed and permission; \$10.00*

AHNR 461 Research Problems in Health and Recreational Education (4) Cross-listed as EDUC 461. Exploration of research methodologies, issues, and problems peculiar to health professions.

AHNR 495 Special Topics (2-4) Cross-listed as EDUC 495. Provides students an opportunity to gain additional knowledge or experience in a specific area or field.

Anthropology

ANTH 101 Introduction to Anthropology (4) An introduction to the biological nature of humans. The roots of primate and hominid evolution, speciation, cultural beginnings, and the processes of evolution in modern humans are examined. *W*

ANTH 199 Topics in Anthropology (1-4) Individual or small-group study, under the supervision of instructor, of topics not otherwise available to students.

ANTH 250 Principles of Cultural Anthropology (4) How humans have adapted as foragers, hunters, farmers, and industrialists. The diversities of preliterate and living human societies, social structure, kinship, religion, and ecology are examined in cross-cultural settings. *Sp*

ANTH 299 Special Topics in Anthropology (1-4) Individual or small-group study, under the supervision of instructor, of topics not otherwise available to students. Separate courses repeatable for credit.

ANTH 340 MesoAmerica Before Columbus (4) Cross-listed as HIST 340. Survey of MesoAmerican settlement prior to the arrival of the Europeans, including origins of the first hunters and gatherers, development of agriculture, Olmec and Zapotec civilizations, rise and fall of Teotihuacan, and settlement and influence of Mayans, Toltecs, and Aztecs up to the arrival of the Spanish.

ANTH 360 Indians of North America (4) Description and analysis of traditional native American cultural areas and impact of modern society on native Americans. *Preq. ANTH 250*

ANTH 371 Islamic Religion, Culture, and Civilization (4) Cross-listed as HIST 371. Survey of the cultural legacy of Islam through an integrated look at the religion, social customs, economic practices, arts, and literature. May be used to meet only one GEP requirement. *W*

AHNR 411 - ANTH 371

ANTH 399 - ARTS 102

ANTH 399 Topics in Anthropology (1-4) Individual or small-group study, under the supervision of instructor, of topics not otherwise available to students.

Art History

ARTH 101 Introduction to Art (4) Beginning study of the nature and purposes of art as seen both in historical and contemporary works (primarily for non-art majors).

ARTH 261 Art History Survey 1 (Prehistoric through Roman) (4) Covering Paleolithic, Egyptian, Near Eastern, Aegean, Greek, Etruscan, and Roman art. *F W*

ARTH 262 Art History Survey 2 (Medieval through Renaissance) (4) Study of Early Christian, Byzantine, Romanesque, Gothic, and Renaissance art. *W Sp*

ARTH 263 Art History Survey 3 (Baroque through Modern) (4) Study of Baroque, Neoclassical, Romantic, Realist, Impressionist, Post Impressionist, and Twentieth Century art. *Sp*

ARTH 310 History of Photography (4) Survey of major figures and ideas involved in the evolution of photography as a creative art form. Offered on demand

ARTH 331 Ceramic History Survey 1 (4) Prehistoric to modern non-Asian, including Egypt, Pre-Columbian American, Middle East, Africa, Europe, U.S.A. Offered on demand

ARTH 332 Ceramic History Survey 2 (4) Asia, China, Korea, Japan, Vietnam, and India. Offered on demand

ARTH 360 Nineteenth-Century Art (4) Study of the visual arts in Europe and America, from Neoclassicism through Postimpressionism, in relation to social and cultural developments of that time.

ARTH 361 Twentieth-Century Art (4) Comparative study of developments in all fields of visual art as expressions of our time.

ARTH 364 North American Survey (4) A survey of American art (colonial through the present). Offered on demand

ARTH 366 Non-Western Survey (4) A survey of non-Western art: Asia, China, Korea Japan, Vietnam, and India. Offered on demand

Art Pedagogy

ARTP 201 Art in the Elementary Curriculum 1 (3) First of two art courses required of those wishing to become certified as elementary teachers in Ohio. The emphasis of these two courses (201 and 202) is to teach the teacher to become a creative coach or a catalyst in the child's artistic growth. Emphasis is on understanding, facilitating, and integrating art into the elementary curriculum. *F W Sp; req. EDUC 110; \$5.00*

ARTP 202 Art in the Elementary Curriculum 2 (3) Continuation of ARTP 201. *F W Sp; req. ARTP 201; \$35.00*

Arts

ARTS 101 Studio Foundations 1 (4) An entry-level class focusing on the dynamics of black and white, two-dimensional media. It provides students with methods of seeing, visualizing, and expressing themselves on paper. Required of all students with BFA major. *F W Sp; \$10.00*

ARTS 102 Studio Foundations 2 (4) An entry-level class which focuses on the use and perception of color. Discussion of various color systems. Color exercises based on theory and historic contexts. Required of all students with BFA major. *W; \$10.00*

ARTS 103 - ARTS 241

- ARTS 103 Studio Foundations 3 (4)** An entry-level course devoted to the concepts and use of three-dimensional materials used in sculptural terms. Required of all students with BFA major. *Sp; \$10.00*
- ARTS 104 Terminology, Tools, and Materials in Graphic Design (4)** Course designed to make students familiar with the "building blocks" used by graphic designers. Hands-on experience with many of the tools used in this profession. Emphasizes the basics of using T-squares, triangles, and technical pens. Demonstrates modern graphic computers. Introduces the many types of materials involved such as rubber cement, acetate, and papers. *F W; \$5.00*
- ARTS 105 The Creative Process (4)** Team-taught and interdisciplinary. Examines the creative process in all the arts via lectures, demonstrations, visiting artists, and films. Special emphasis is given to artists' statements about themselves and the role of the arts in the development of civilization. Required of all students with BFA major. *Sp*
- ARTS 205 Graphic Design Reproduction Techniques (4)** A course designed to familiarize the graphic design student with the various methods of reproducing the finished art work. Discussion of various methods of printing, color separation, and electronic media. Lectures, demonstrations, field trips, and studio work are included. *F W; \$5.00*
- ARTS 210 Photography 1 (4)** An introduction to the art and techniques of photography. Student must provide 35mm camera. *Su F W Sp; \$25.00*
- ARTS 211 Photography 2 (4)** Continued exploration of photographic techniques. Student must provide 35mm camera. *Su F W Sp; req. ARTS 210; \$25.00*
- ARTS 212 Photography 3 (4)** Continuation of ARTS 211. Student must provide 35mm camera. *Su F W Sp; req. ARTS 211; \$25.00*
- ARTS 215 Photography for the Graphic Designer (4)** An introduction to the basic knowledge of photography for the graphic designer, covering the basics of setting up, lighting, and designing photo compositions. *Offered on demand; \$25.00*
- ARTS 221 Painting 1 (4)** A focus on individual expression through the use of oil and acrylic painting mediums. *Su F W Sp; req. ARTS 101, 102, or permission; \$5.00*
- ARTS 222 Painting 2 (4)** Continuation and expansion of ideas developed in ARTS 221. *Su F W Sp; req. ARTS 221; \$5.00*
- ARTS 223 Painting 3 (4)** Extension of the concepts developed in ARTS 222. *Su F W Sp; req. ARTS 222; \$5.00*
- ARTS 231 Ceramics 1 (4)** Entry-level course focusing on the use of clay in creating hand built pottery and forms. Basics of glazing work are covered. *F W Sp; \$25.00*
- ARTS 232 Ceramics 2 (4)** Entry-level course focusing on the use of the potter's wheel to create basic thrown forms. *F W Sp; \$25.00*
- ARTS 233 Ceramics 3 (4)** Concentration on the combination of hand built and wheel thrown forms and further study of glaze techniques. *F W Sp; req. ARTS 231 and 232; \$25.00*
- ARTS 238 Wood Design 1 (4)** This course explores the basis for using wood as a design/sculpture medium. Initial understanding of tool use and safety practices is the focal point of this first class. *F W; \$10.00*
- ARTS 239 Wood Design 2 (4)** Extension of ARTS 238. Students having a solid background in the use of woodworking tools concentrate on achieving aesthetic/artistic results in their individual design projects. *F W; \$10.00*
- ARTS 240 Wood Design 3 (4)** Extension of ARTS 239. Promotes further exploration of the medium. *W Sp; \$10.00*
- ARTS 241 Sculpture 1 (4)** Course designed to develop the student's ability to conceive and build three-dimensional forms in various media (plaster, clay, wood, and metal). Understanding of shapes and mass, acquaintance with tools, techniques, and materials for expression. *F W Sp; \$10.00*

ARTS 242 - ARTS 293

- ARTS 242 Sculpture 2 (4)** Intermediate sculpture course designed to further a student's skill in three-dimensional work. Technical procedures include advanced wood-carving, clay molding, stone carving, and various direct over armature methods. *F W Sp; preq. ARTS 241; \$10.00*
- ARTS 243 Sculpture 3 (4)** Studio problems based on concepts applied to various three-dimensional materials. Advanced sculpture places special emphasis on the development of individual expression in the student's chosen medium. *F W Sp; preq. ARTS 242; \$10.00*
- ARTS 244 Introduction to Printmaking (4)** A studio course utilizing basic techniques in relief printing and screen printing. *Offered on demand; \$5.00*
- ARTS 245 Intaglio (4)** Introduction to basic intaglio techniques. Emphasis on mastering techniques used to develop personal imagery. *Offered on demand; preq. ARTS 101 and 102; \$5.00*
- ARTS 246 Lithography (4)** An introduction to basic lithographic technique and printing. Emphasis is placed on mastering techniques used to further personal aesthetic goals. *Offered on demand; preq. ARTS 101 and 102; \$5.00*
- ARTS 247 Screen Printing (4)** An introduction to basic silk screen techniques. Emphasis is on mastering techniques used to develop personal imagery. *Su F W Sp; preq. ARTS 101 and 102; \$5.00*
- ARTS 248 Relief Printing (4)** An introductory course employing the range of graphic possibilities in the relief printing process. *Offered on demand; preq. ARTS 101 and 102; \$5.00*
- ARTS 251 Typography for the Graphic Designer (4)** Studio course beginning with some basic background in type design and theory and working through its use in modern graphic design. Use of transfer lettering, type sizing, and specifications in graphic design. *Offered on demand; \$5.00*
- ARTS 252 Basic Illustration (4)** Studio course beginning with design basics and integrating these basics into illustration techniques for the graphic designer. Black and white graphics and color techniques. *F W Sp; \$5.00*
- ARTS 253 Illustration (4)** Extension of ARTS 252. The instructor helps the student develop a portfolio. *Offered on demand; preq. ARTS 252; \$5.00*
- ARTS 271 Life Drawing 1 (4)** Drawing from a model in black and white media. Repeatable for credit—maximum of two quarters. *Su F W Sp; preq. ARTS 101 or permission; \$5.00*
- ARTS 272 Life Drawing 2 (4)** Continuation of ARTS 271. Repeatable for credit—maximum of two quarters. *Su F W Sp; preq. ARTS 271; \$5.00*
- ARTS 273 Life Drawing 3 (4)** Continuation of ARTS 272. Repeatable for credit—maximum of two quarters. *Su F W Sp; preq. ARTS 272; \$5.00*
- ARTS 275 Drawing 1 (4)** Extension of ARTS 101 and 102. Focus is on developing drawing skills (perspective, composition, etc.) through the use of colored pencils and advanced black and white media. *Su F W Sp; preq. ARTS 101 and 102; \$5.00*
- ARTS 276 Drawing 2 (4)** Continuation of ARTS 275. Students are expected to demonstrate increased facility and conceptualization. *Su F W Sp; preq. ARTS 275; \$5.00*
- ARTS 277 Drawing 3 (4)** A continuation of concepts developed in ARTS 275 and ARTS 276. *F W Sp; preq. ARTS 276*
- ARTS 292 Fabric Design 1 (4)** Printing and dyeing fabric as well as applying design to cloth. *F W Sp; \$10.00*
- ARTS 293 Fabric Design 2 (4)** Continuation of ARTS 292. *F W Sp; preq. ARTS 292; \$10.00*

- ARTS 294 Fabric Design 3 (4)** Continuation of ARTS 293. *F W Sp; req. ARTS 293; \$10.00*
- ARTS 299 Topics in Art (1-4)** Opportunity for the student to plan and complete a project which meets with the approval of the staff member supervising this arranged course. Repeatable for credit. *Su F W Sp; req. permission of staff; \$5.00*
- ARTS 303 Elementary Art Methods (4)** Focus is on implementing studio techniques with the elementary student. *Offered on demand*
- ARTS 304 Secondary Art Methods (4)** The aesthetic rationale and hands-on methodology of teaching art in the upper grades. Included are: studio projects, history, appreciation, and theory.
- ARTS 310 Intermediate Photography 1 (4)** Continuation of ARTS 212 utilizing more advanced dark room and camera techniques. *Su F W Sp; req. ARTS 212; \$15.00*
- ARTS 311 Intermediate Photography 2 (4)** Utilizes techniques taught in ARTS 310 with emphasis on artistic growth in the medium. *Su F W Sp; req. ARTS 310; lab fee \$15.00*
- ARTS 312 Intermediate Photography 3 (4)** Utilizes techniques taught in ARTS 311. Individualizes instruction promoting continued artistic growth in the medium. *Su F W Sp; req. ARTS 311; \$15.00*
- ARTS 321 Intermediate Painting 1 (4)** Oil and acrylic painting used to extend concepts developed in earlier painting courses. Individual concepts highly stressed. *Su F W Sp; req. ARTS 223; \$5.00*
- ARTS 322 Intermediate Painting 2 (4)** *Su F W Sp; req. ARTS 321; \$5.00*
- ARTS 323 Intermediate Painting 3 (4)** *Su F W Sp; req. ARTS 322; \$5.00*
- ARTS 324 Watercolor 1 (4)** Series of courses which focuses on the use of transparent watercolors to extend personal imagery. *Su F W Sp; req. ARTS 101, 102, or permission; \$5.00*
- ARTS 325 Watercolor 2 (4)** Continuation of ARTS 324. *Su F W Sp; req. ARTS 324; \$5.00*
- ARTS 326 Watercolor 3 (4)** Continuation of ARTS 325. *Su F W Sp; req. ARTS 325; \$5.00*
- ARTS 327 Figure Painting 1 (4)** Painting the human figure from a model in oil or acrylic. *F W Sp; req. ARTS 223; \$5.00*
- ARTS 328 Figure Painting 2 (4)** Continuation of ARTS 327. *F W Sp; req. ARTS 327; \$5.00*
- ARTS 329 Figure Painting 3 (4)** Continuation of ARTS 328. Emphasis on individual style and technique as opposed to strictly objective rendering. *F W Sp; req. ARTS 328; \$5.00*
- ARTS 331 Intermediate Ceramics 1 (4)** Intermediate hand built techniques, including use of clay and glazes. A continuation of ARTS 231. *F W Sp; req. ARTS 231; \$25.00*
- ARTS 332 Intermediate Ceramics 2 (4)** Intermediate throwing techniques, including decorative techniques. *F W Sp; req. ARTS 232; \$25.00*
- ARTS 333 Intermediate Ceramics 3 (4)** A continuation of concepts developed in ARTS 233. *F W Sp; req. ARTS 233; \$10.00*
- ARTS 334 Raku Ceramics (4)** Introduction to the philosophy and techniques of the traditional Japanese ceramic ware called "Raku." *Sp; req. ARTS 231 or 232; \$25.00*
- ARTS 335 Porcelain Ceramics (4)** For advanced students of the potter's wheel. History, use, and glazing of porcelain. *W; req. permission of staff; \$25.00*
- ARTS 336 Glaze Theory and Practice (4)** Understanding of the many standard types of ceramic glazes. *Offered on demand; \$25.00*

ARTS 294 - ARTS 336

ARTS 338 - ARTS 411

- ARTS 338 Mold Making (4)** History and development of ceramic mold making. Techniques to be addressed: bisque molds, press molds, sprigging, jigger and jolley processes, casting, ram pressing, and plaster technology. *Offered on demand*
- ARTS 341 Intermediate Sculpture 1 (4)** Techniques of sculptural expression in the "additive" mode: clay, wax, found elements. *F W Sp; preq. ARTS 243; \$10.00*
- ARTS 342 Intermediate Sculpture 2 (4)** Experience with low and high relief sculpture in "subtractive" processes: carving and sandblasting in glass, clay, wood, stone, plastics. *F W Sp; preq. ARTS 341; \$10.00*
- ARTS 343 Intermediate Sculpture 3 (4)** Relief and small full-round sculpture by casting processes: soft metals, plaster, plastics. *F W Sp; preq. ARTS 342; \$10.00*
- ARTS 345 Intermediate Intaglio (4)** Continuation of ARTS 245. Intermediate level techniques in etching and plate production combined with use of printing papers in producing an individualized image. *Offered on demand; preq. ARTS 245; \$5.00*
- ARTS 346 Intermediate Lithography (4)** Continuation of ARTS 246. Individual styles and techniques in lithography and advances by understanding more advanced methods of register paper ink use. *Offered on demand; preq. ARTS 246; \$5.00*
- ARTS 347 Intermediate Screen Printing (4)** Continuation of ARTS 247. Introduction of new techniques in manual and photo screen print production. *Offered on demand; preq. ARTS 247; \$5.00*
- ARTS 371 Intermediate Life Drawing 1 (4)** Working from a model developing a unique personal approach to drawing. Repeatable for credit—maximum of two quarters. *Su F W Sp; preq. ARTS 101; \$5.00*
- ARTS 372 Intermediate Life Drawing 2 (4)** Continuation of ARTS 371. Repeatable for credit—maximum of two quarters. *Su F W Sp; preq. ARTS 101; \$5.00*
- ARTS 373 Intermediate Life Drawing 3 (4)** Continuation of ARTS 372. Repeatable for credit—maximum of two quarters. *Su F W Sp; preq. ARTS 101; \$5.00*
- ARTS 375 Intermediate Drawing 1 (4)** Development of a personal style of expression in two-dimensional drawing mediums. *Su F W Sp; preq. ARTS 277; \$5.00*
- ARTS 376 Intermediate Drawing 2 (4)** Continuation of ARTS 375. *Su; preq. ARTS 375; \$5.00*
- ARTS 399 Topics in Art (1-4)** Opportunity for the student to plan and complete a project which meets with the approval of the staff member supervising this arranged course. Repeatable for credit. *Su F W Sp; preq. permission of staff; \$50.00*
- ARTS 401 Studio Methods for Elementary Education (6)** Cross-listed as EDUC 431. The methodologies, techniques, and materials of art instruction for elementary students. The special needs of students in grades K-8 are addressed. The appropriate range of activities and media are explored to maximize art instruction and its integration into the larger educational process. *Preq. ARTH 101, ARTS 101, 102, 103, and admission to teacher education program; coreq. ARTS 402; \$25.00*
- ARTS 402 Studio Methods for Secondary Education (6)** Cross-listed as EDUC 432. The methodologies, techniques, and materials of art instruction for adolescents. The special needs of students in grades 9-12 are addressed. The appropriate range of activities and media are explored to maximize art instruction and its integration into the larger educational process. *Preq. ARTH 101, ARTS 101, 102, 103, and admission to teacher education program; coreq. ARTS 401; \$25.00*
- ARTS 410 Advanced Photography 1 (4)** Advanced techniques in individualized areas such as lighting, color, and photographing the figure. *F W Sp; preq. ARTS 312; \$5.00*
- ARTS 411 Advanced Photography 2 (4)** Continuation of ARTS 410. *W Sp; preq. ARTS 410; \$5.00*

ARTS 412 - ARTS 499

- ARTS 412 Advanced Photography 3 (4)** Continuation of ARTS 411 and presentation of senior portfolio. *Sp; preq. ARTS 411; \$5.00*
- ARTS 421 Advanced Painting 1 (4)** *F W Sp; preq. ARTS 326; \$5.00*
- ARTS 422 Advanced Painting 2 (4)** *F W Sp; preq. ARTS 421; \$5.00*
- ARTS 423 Advanced Painting 3 (4)** Focus on helping the artist develop a coherent/cohesive body of work (developing an individual style). *F W Sp; preq. ARTS 422; \$5.00*
- ARTS 424 Advanced Watercolor 1 (4)** Continuation of ARTS 326 with more emphasis on individual style and use of more advanced materials such as special papers, etc. *Su F W Sp; preq. ARTS 326; \$5.00*
- ARTS 425 Advanced Watercolor 2 (4)** Continuation of ARTS 424 with a widening dialog of expression based on individual style. Combined with experiments in the medium. *Su F W Sp; preq. ARTS 424; \$5.00*
- ARTS 426 Advanced Watercolor 3 (4)** Continuation of ARTS 425 combined with a presentation of senior portfolio. *Su F W Sp; preq. ARTS 425; \$5.00*
- ARTS 427 Advanced Figure Painting 1 (4)** Painting from a model in oil or acrylic. *F W Sp; preq. ARTS 329; \$5.00*
- ARTS 428 Advanced Figure Painting 2 (4)** Painting from a model in oil or acrylic. *F W Sp; preq. ARTS 427; \$5.00*
- ARTS 429 Advanced Figure Painting 3 (4)** Continuation of ARTS 428. Considerable progress in a personal style is encouraged with emphasis on using the human form as a basis for advanced work. *F W Sp; preq. ARTS 428; \$5.00*
- ARTS 434 Advanced Raku (4)** Continuation of ARTS 334. The Raku philosophy as applied to modern and western forms. *Offered on demand; preq. permission of staff; \$25.00*
- ARTS 435 Advanced Porcelain (4)** Continuation of ARTS 335. Commercial and self-formulated porcelain applied to larger works. *Offered on demand; preq. permission of staff; \$25.00*
- ARTS 436 Advanced Glaze Theory and Practice (4)** Continuation of ARTS 336. Compounding and testing of self-designed glazes. *Offered on demand; preq. ARTS 336; \$25.00*
- ARTS 441 Advanced Sculpture 1 (4)** Techniques of casting in full-round, high-temperature, "harder" metals (bronze, aluminum) using the cire perdue process. *F W Sp; preq. ARTS 343; \$10.00*
- ARTS 442 Advanced Sculpture 2 (4)** Emphasizes personal expression and the development of style in combinations of the foregoing technical processes. *F W Sp; preq. ARTS 441; \$10.00*
- ARTS 443 Advanced Sculpture 3 (4)** Continuation of personal development. Introduction to land art, monument art, environment art, happenings, performance art. *F W Sp; preq. ARTS 442; \$10.00*
- ARTS 475 Advanced Drawing 1 (4)** Continuation of ARTS 376. *Su F W Sp; preq. ARTS 376; \$5.00*
- ARTS 476 Advanced Drawing 2 (4)** Continuation of ARTS 475. *Su F W Sp; preq. ARTS 475; \$5.00*
- ARTS 480 Senior Studio 1 (4)** This course (and ARTS 481) must be taken the senior year in the area of the student's concentration. Arranged time. *Offered on demand; \$5.00*
- ARTS 481 Senior Studio 2 (4)** This course must be in the area of the student's concentration. Arranged time. *Offered on demand; preq. ARTS 480; \$5.00*
- ARTS 499 Topics in Art (1-4)** Opportunity for the student to plan and complete a project which meets with the approval of the staff member supervising this arranged course. Repeatable for credit. *Su F W Sp; preq. permission of staff; \$50.00*

BIOL 099 - BIOL 303

Biology

- BIOL 099 Fundamental Biology (4)** Designed for students with an inadequate background in biological science or those students with no high school biology who plan to enter one of the allied health programs. Material presented is intended to increase familiarity with terms and chemical processes. *Su F W Sp*
- BIOL 101 Introduction to Biology (3)** An introduction to basic concepts of biology for health science students.
- BIOL 151 Principles of Biology (5)** Introduction to principles and concepts of life; emphasis on interrelationships of structural, functional, reproductive, evolutionary, and ecological principles related to cells and organisms. *4 lec. 2 lab; \$30.00*
- BIOL 162 Human Anatomy and Physiology (5)** A general survey of the structure and function of the human body. Not applicable for students requiring BIOL 310 and BIOL 320. *W; preq. BIOL 101 or 151; 4 lec. 2 lab; \$25.00*
- BIOL 202 Principles of Plant Biology (5)** Anatomy and morphology of seed plants are related to the functional aspects of photosynthesis, growth, transport, and reproduction. Practical emphasis on plant/man interactions. Brief survey of plant kingdom with focus on life histories and evolutionary relationships. *Sp; preq. BIOL 151; 4 lec. 2 lab; \$10.00*
- BIOL 203 Principles of Animal Biology (5)** Principles of animal taxonomy, structure, function, development, and behavior. Laboratory survey of major phyla. *W; preq. BIOL 151; 4 lec. 3 lab; \$20.00*
- BIOL 210 Taxonomy of Vascular Plants (4)** Principles of classification of extinct and extant seed plants with emphasis on family recognition. Collection, identification, and preservation of seed plants. *As needed; 3 lec. 2 lab; \$5.00*
- BIOL 212 Forestry Management and Practices (4)** Investigation of the development and the existing practices of modern forestry in the U. S. Basic management practices are discussed with laboratory exercises designed to improve forest management skills. *Offered on demand; preq. BIOL 202; 3 lec. 2 lab*
- BIOL 220 Wildlife Management (4)** A study of ecological principles of the management of wild animals, both game and non-game species. The economic importance of wildlife and the role of various wildlife agencies are also considered. *Offered on demand; 3 lec. 2 lab; \$10.00*
- BIOL 271 Field Ornithology (4)** A study of the classification, adaptation, and habitat requirements of birds with particular emphasis on Ohio species. Field identification is emphasized in lab. *3 lec. 3 lab; Sat. field trip; \$22.00*
- BIOL 272 Ohio's Natural Heritage (4)** An exploration of the natural history of Ohio. Arranged field trips visit all five of Ohio's physiographic regions. *3 lec. 3 lab arranged; Saturday field trip; \$21.00*
- BIOL 290 Seminar in Lifes Sciences (1-4)** Discussion of advanced topics in the life sciences.
- BIOL 301 Invertebrate Paleobiology (4)** Cross-listed as GEOL 301. An introduction to major groups of invertebrates that are commonly preserved in rocks. Emphasis on preservation, morphology, collection, and geological and biological significance of invertebrate fossils. *Preq. GEOL 202 or instructor permission; 3 lec. 2 lab; \$5.00*
- BIOL 302 Dendrology (4)** Collection, identification, nomenclature, classification, and ecological relationship of native, introduced, and cultivated woody plants. *As needed; 3 lec. 2 lab; \$15.00*
- BIOL 303 Spring Flora (4)** Identification, nomenclature, and classification of spring flowering plants. Origin and evolution of flora in Ohio. *3 lec. 2 lab*

- BIOL 307 General Entomology (5)** An introduction to the morphology and classification of insects. The major orders, families, and species of economic importance, both beneficial and pest, are emphasized. Students collect and identify local species. 4 lec. 2 lab; \$15.00
- BIOL 310 Principles of Anatomy (5)** An introduction to morphology of tissues and systems of the human body. *F W; preq. BIOL 101 or 151; 4 lec. 3 lab; \$35.00*
- BIOL 311 Kinesiology (4)** Concentration on skeletal and muscle systems and their functional interplay in the analysis of motion. *Preq. BIOL 162 or 310; 3 lec. 2 lab; \$20.00*
- BIOL 312 Sectional Anatomy (3)** An introduction to sectional human anatomy. *Preq. BIOL 162 or 310; 2 lec. 2 lab; \$30.00*
- BIOL 314 Human Neuroanatomy (5)** A detailed anatomy of the human nervous system with attention to functional and clinical considerations. *Preq. BIOL 162 or 310; 4 lec. 2 lab; \$40.00*
- BIOL 315 Histology (5)** Study of the microscopic structure of cells, tissues, and organ systems and their physiological properties. *Preq. BIOL 162 or 310; 4 lec. 2 lab; \$15.00*
- BIOL 320 Principles of Physiology (5)** An introduction to human systems physiology. *Preq. BIOL 162 or 310*
- BIOL 321 Physiology Lab (2)** Laboratory designed to complement BIOL 320. Exercises illustrate basic physiological principles and techniques, with emphasis on the human. *Preq. or Coreq. BIOL 320; 1 discussion 3 lab*
- BIOL 330 Ecology (5)** A study of the interrelationships among the many elements in an environment. A historical approach to the concept of evolution, man's impact upon the environment, and common ecological problems faced by society. Labs introduce common and basic ecological techniques. *F; preq. BIOL 202; 4 lec. 2 lab; Saturday field trip; \$22.00*
- BIOL 331 Advanced Field Biology (4)** Examination of the principles and techniques of biological field investigation. *Offered on demand; preq. BIOL 330; 3 lec. 3 lab; Saturday field trip; \$10.00*
- BIOL 340 Genetics (5)** Principles and concepts of genetics as revealed by classical and modern investigation. Transmission, molecular, and population genetics are examined. *F; preq. BIOL 151 and CHEM 122 or 142*
- BIOL 341 Genetics Lab (2)** Experiments and experiences designed to illustrate principles of genetics. *Preq. or coreq. BIOL 340; 4 lab; \$30.00*
- BIOL 350 Microbiology (5)** A survey of representative types of microorganisms. Emphasis is placed on cellular structure and physiology, nutritional, and environmental requirements and methods of reproduction. Introduction to the role of pathogenic organisms in diseases, principles of immunity and resistance to disease. Laboratory includes methods of sterilization, culturing, staining, and identification of bacteria. *Su F; preq. BIOL 101 or 151; 4 lec. 3 lab; \$35.00*
- BIOL 360 Plant Anatomy and Morphology (5)** Detailed study of vascular plant anatomy and morphology considered from an evolutionary viewpoint. Labs involve study of anatomy and morphology of all major vascular plant groups, extinct and extant. *Offered on demand or by arrangement; preq. BIOL 202; 4 lec. 2 lab; \$10.00*
- BIOL 365 Phycology (5)** An introduction to the taxonomy, morphology, evolution, and ecology of terrestrial, freshwater, and marine algae. Practice in identifying local species. *Preq. BIOL 151; 4 lec. 2 lab; \$10.00*
- BIOL 370 Marine Biology (5)** An introduction to marine biology, including the areas of oceanography and ecology. All biological principles are infused into discussions with marine themes. *Preq. BIOL 151; 4 lec. 2 lab; \$30.00*
- BIOL 395 Special Topics in Biology (1-4)** Individual or small-group study, under the supervision of instructor, of topics not otherwise available to students.

BIOL 307 - BIOL 395

BIOL 405 - BMSC 450

BIOL 405 Animal Behavior (5) Study of patterns of animal behavior including ecological, physiological, and developmental mechanisms which regulate their formation and occurrence. *Preq. BIOL 203 or permission; 4 lec. 3 lab; \$25.00*

BIOL 407 Diagnostic Microbiology (5) Diagnostic procedures for the recovery and identification of medically important bacteria and fungi. Emphasis is on the morphological, cultural, biochemical, and serological characteristics of various pathogenic bacteria and fungi. *Preq. BIOL 350; 3 lec. 6 lab*

BIOL 410 Advanced Human Anatomy (5) A regional approach to the anatomy of the human body utilizing cadaver dissection. *Preq. BIOL 162 or 310; 4 lec. 3 lab; \$60.00*

BIOL 411 Biochemistry (4) Cross-listed as CHEM 411. General principles of the structural and functional properties of carbohydrates, lipids, nucleic acids, and proteins. This course can be counted as a concentration area in biology or chemistry. *Preq. CHEM 307; 4 lec.*

BIOL 420 Mammalogy (5) A study of the structural features, evolution, and classification of mammals, especially of Ohio. Other topics include ecology, zoogeography, behavior, reproductive strategies, physiological adaptations to extreme environments, and economic aspects. *Preq. BIOL 151 or equivalent; 4 lec. 3 lab; \$30.00*

BIOL 432 Cell Biology (5) Current survey of the structure and function of eukaryotic and prokaryotic cells, including recent advances in molecular biology and tissue culture technique. *Preq. BIOL 340*

BIOL 450 Immunology (4) Study of antigen and antibodies with emphasis on in vivo and in vitro reactions, including recent information in immunogenetics and monoclonal strategies. *Preq. BIOL 350*

BIOL 470 Plant Physiology (5) A general introduction, including plant/soil, plant/water relationships, mineral nutrition, photosynthesis, and growth integrated with related aspects of biophysics. *As needed; preq. BIOL 202 and 360; 4 lec. 2 lab; \$30.00*

BIOL 485 Senior Project (1-4) In-depth study of a selected topic in the life sciences, culminating in the preparation of a senior paper. *Su F W Sp; preq. junior or senior standing; \$15.00*

BIOL 490 Seminar in the Life Sciences (1-4) Discussion of advanced topics in the life sciences. *Preq. junior or senior standing*

BIOL 495 Undergraduate Research (1-4) Independent life science investigation under the direction of a faculty member. *Preq. junior or senior standing; \$30.00*

BIOL 499 Special Topics in Life Science (1-4) Individual or small-group study, under the supervision of instructor, of topics not otherwise available to students.

Biomedical Sciences

BMSC 340 Medical Genetics (4) The study of genetics as it relates to medically significant variation and heredity in man. *Preq. BIOL 350*

BMSC 411 Medical Biochemistry (4) A study of medically significant biochemical structure and reactions as they occur in living systems. *Preq. BIOL 350 and CHEM 305*

BMSC 432 Molecular Biology (4) Basic molecular concepts and procedures used in the diagnosis and characterization of genetic disease and malignancy. *Preq. BIOL 350*

BMSC 450 Medical Immunology (4) Study of the immune system, with special emphasis on immunologic methods used in medicine and immune-mediated diseases that are frequently diagnosed and evaluated by immunological methods. *Preq. BIOL 350*

Accounting

- BUAC 101 Accounting 1 (4)** Introduction to accounting concepts and procedures. The accounting cycle: nature of accounts and techniques of recording, classifying, summarizing and analyzing basic financial data. Accounting for the formation and operation of business enterprises. *F W Sp; \$20.00*
- BUAC 102 Accounting 2 (4)** Application of fundamental accounting techniques for cash, long term investments, notes and accounts, inventory methods, plant and equipment, and liabilities. Introduction to manufacturing operations, cost methods, and management's need of cost data. *W Sp Su; preq. BUAC 101; \$20.00*
- BUAC 103 Accounting 3 (4)** Reporting and analyzing financial data. Financial statement introduction, analysis, and interpretation to meet the needs of modern management. Introduction to accounting techniques applicable to parent and subsidiary companies and departmental and branch operations. Budgeting as an aid to management and the importance of income tax considerations in financial decisions. *Sp Su; preq. BUAC 102; \$20.00*
- BUAC 110 Payroll Records/Accounting (4)** A basic course in the maintenance of personnel and payroll records as required by the Fair Labor Standards Act and the various federal and state laws covering the withholding and payment of payroll related taxes. *Sp Su; preq. BUAC 101 or 201; \$30.00*
- BUAC 201 Financial Accounting Principles (4)** An introduction to the concepts and principles underlying financial accounting theory. The study includes the accounting equation and its application to the business entity. Procedures and concepts in accumulating and reporting financial information are developed. (Not open to students who have completed BUAC 101 and 102.) *F W; preq. sophomore standing; \$20.00*
- BUAC 203 Managerial Accounting (4)** A study of the financial information needs of management for decision making. Includes the development of financial statements for manufacturing entities, the study of the components of unit cost, variable costing, and cost-volume-profit analysis. *W Sp; preq. BUAC 201; \$20.00*
- BUAC 215 Tax Accounting (4)** Current income tax law and regulations related to business and individual income tax reporting. Practice in preparation of tax returns of businesses and individuals. *Sp Su; preq. BUAC 103 or 203; \$20.00*
- BUAC 221 Cost Accounting 1 (4)** Introduction to cost accounting systems and methods. Cost concepts, classifications, and measurement techniques in relation to their importance in determination, planning, and control. Job order and process cost accounting methods. *F; preq. BUAC 103 or 203; \$20.00*
- BUAC 222 Cost Accounting 2 (4)** Estimating, planning, and controlling the costs of processes and projects. Standard cost accounting procedures and the analysis of variances. Cost and profit responsibility reporting to management. Uses of cost and profit data in project selection, product pricing, and other functions of management. *W; preq. BUAC 221; \$20.00*
- BUAC 231 Intermediate Accounting 1 (4)** A more advanced treatment of accounting theory; determination of income realization and cost expiration. Primary emphasis is on asset accounts in order listed on the balance sheet. *F; preq. BUAC 103 or 203; \$20*
- BUAC 232 Intermediate Accounting 2 (4)** Continuation of BUAC 231 with emphasis on the balance sheet sections dealing with investments, fixed assets, and liabilities. *W; preq. BUAC 231; \$20.00*
- BUAC 233 Intermediate Accounting 3 (4)** Continuation of BUAC 232 with detailed study of the owner's equity section of the balance sheet and the financial statements presentation and analysis. *Sp; preq. BUAC 232; \$20.00*
- BUAC 250 Accounting Projects 1 (1-4)** A special course designed to permit the accounting student to work on special projects under the supervision of an instructor with expertise in the area of the student's project. The special projects course will enable the accounting student to apply the accounting theory as covered in other courses. *Not regularly offered; preq. departmental permission (see accounting advisor).*

BUAC 101 - BUAC 250

BUAC 261 - BUAC 499

- BUAC 261 Accounting with D. P. Applications 1 (4)** Application of basic accounting procedures to the microcomputer. Emphasizes applications to the IBM microcomputer system. *Not regularly offered; req. BUAC 103 and BUIS 101*
- BUAC 299 Special Topics 1 (1-4)** Opportunity for accounting students to continue their study of accounting in specialized areas under the supervision of an instructor with expertise in those areas. *Not regularly offered; req. departmental permission (see accounting advisor); see special note on page 105; \$20.00*
- BUAC 305 Governmental Accounting (4)** A basic introduction to the accumulation and use of accounting information in non-profit organizations. General principles applying to budgets and funds are examined rather than specific application. An especially useful course for nonaccounting (and accounting) students who will be employed in governmental units where budgeting and accounting are required. *W Su; req. BUAC 103 or 203 and permission or BUAC 231; \$20.00*
- BUAC 311 Accounting Projects—Advanced (1-4)** A special course designed to permit the advanced accounting student to work on special projects under the supervision of an instructor with expertise in the area of the student's project. The special projects course will enable the accounting student to apply the accounting theory as covered in other courses. *Not regularly offered; req. BUAC 233 and departmental permission.; \$20.00*
- BUAC 330 Industrial Accounting (4)** Study of the use of data by management in planning and controlling business operations. Emphasis on the solution of problems confronting management by the use of accounting information in analytical form. *Not regularly offered; req. BUAC 103, 203, or permission; \$20.00*
- BUAC 339 Special Problems in Financial Accounting (4)** Continuation of financial accounting theory with application to special problems frequently encountered in business. Topics of study include business combinations, accounting for leases and casualty losses, accounting from incomplete records, and an introduction to partnership accounting. *F alternating years; req. BUAC 221 and 233*
- BUAC 360 Systems Accounting (4)** A course in accounting information systems principles and applications. The application of accounting principles to computerized environment, including transaction processing and internal controls, revenue and expenditure cycle applications, software systems, and computer security. *F; req. BUIS 101 and BUAC 103 or 203; \$30.00*
- BUAC 410 Health Care Accounting/Administration (4)** The use of accounting information in planning and controlling the operations of health care organizations. Budgeting and the specialized cost accounting applications of health care organizations are included. *Not regularly offered; req. BUAC 103 or 203; \$20.00*
- BUAC 431 Advanced Accounting 1 (4)** A study of the modern complex corporate environment. Emphasis on accounting for corporate combinations and the special problems arising from mergers and acquisitions. *F alternating years; req. BUAC 221 and 233*
- BUAC 433 Advanced Accounting 2 (4)** A study of special applications of accounting systems and procedures such as foreign currency translation, home office and branch accounting, accounting for distressed entities, and partnership accounting. *Sp alternating years; req. BUAC 221 and 233*
- BUAC 435 Auditing (4)** Independent audits, professional ethics, legal liability, internal control, auditing standards, work sheet applications and procedures. Concern is given to audit evidence, the auditor's approach and techniques, summary reports, statistical sampling, and role of advisory services to management. *Sp alternating years; req. BUAC 222 and 233*
- BUAC 499 Special Topics—Advanced (1-4)** Opportunity for the advanced accounting student to continue the study of accounting in a specialized area of accounting under the supervision of an instructor with expertise in the area. *Not regularly offered; req. departmental permission (see accounting advisor); see special note on page 105; \$20.00*

Automated Information Systems

- BUAI 101 Introduction to Automated Information Systems (4)** A study of computer history, systems, concepts, applications, and social implications. Laboratory activities include basic microcomputer operation and introduction to popular software packages such as Microsoft Windows and Office Pro. *Su F W; \$30.00*
- BUAI 103 Computer Applications (4)** Hands-on study in the use of advanced microcomputer concepts in the areas of word processing, spreadsheets, database management, and presentation graphics. *Su F W Sp; req. BUAI 101 or BUIS 101; \$30.00*
- BUAI 201 IS Fundamentals, Theory, and Practice (4)** Provides the basis for understanding major components of the discipline: information systems, planning and management, information technology, and organization systems, including ethical and legal issues related to IS. *F; req. BUAI 101 and 103*
- BUAI 299 Special Topics in Automated Information Systems 1 (1-4)** Opportunity for the student to work on special projects under the supervision of an instructor with expertise in the area of the student's project. *Not regularly offered; req. instructor permission; see special note on page 105.*
- BUAI 301 Information Technology Hardware and Software (4)** Provides breadth and depth in the technical aspects of the discipline, including discussions and practice in information technology hardware, architectures, and peripheral devices. Theory of systems software, operating systems environment, and resources. Operating systems functions also explored. *W; req. BUAI 201; \$30.00*
- BUAI 310 Data Base Management (4)** Data base system design, implementation, and access using a relational data base and fourth generation programming language. Laboratory project required. *Su F Sp; req. BUAI 103 or BUIS 204 or advisor permission for BUOA majors; \$30.00*
- BUAI 320 Systems Analysis and Design (4)** The study and methodology of how computer information systems are developed and implemented successfully. Discussion of the role of the systems analyst in contrast to the programmer analyst. CASE tools and structured analysis and design techniques are studied. *F; req. BUAI 103 or BUIS 204*
- BUAI 330 Data and Object Structures in Programming (4)** Data structures as used in C and C++ are defined and studied. Control structures, C++ classes, and object oriented programming (OOP), their impact on systems development, and their use in developing computer information systems are also included. *Sp; req. BUIS 201; \$30.00*
- BUAI 421 Physical Design and Implementation with Database Management Systems (4)** Conceptual and logical models for database design, data modeling applications, testing, and implementation. Database application development project. *F; req. BUAI 310; \$30.00*
- BUAI 422 IS Applications Within a Programming Environment (4)** Detailed systems design and development using a programming language. Term project developing and implementing a subsystem. *W; req. BUIS 105 and 201; \$30.00*
- BUAI 430 Information Systems Deployment and Management (4)** Students engage in significant project with minimal supervision for a real or simulated client. Project includes determination of physical flows based on reengineering of functions, database, logical and physical design, functional analysis, development, conversion, and implementation design. Readings and discussion related to management of the IS function, systems integration, and project management to ensure project quality. *Not regularly offered; req. BUAI 421 and 422; \$30.00*
- BUAI 499 Special Topics in Automated Information Systems 2 (1-4)** Opportunity for the advanced student to work on special projects under the supervision of an instructor with expertise in the area of the student's project. *Not regularly offered; req. instructor permission; see special note on page 105.*

BUAI 101 - BUAI 499

BUBA 490S - BUFI 315

Business Administration

BUBA 490S Senior Seminar (4) Provides an opportunity for students to place their chosen field of study in an interdisciplinary context with intellectual, ethical, and historical perspectives. The seminar focuses on the synthesis and integration of various concepts by applying them to the analysis and solution of problems chosen in the context of their academic disciplines. Oral and written presentations of the seminar paper are required. *Su F W Sp; req. senior standing and 44 general education program hours*

Banking and Finance

BUFI 101 Principles of Banking and Finance (4) Monetary standards, commercial and central banking. Federal Reserve functions and statements, monetary and income theory, problems of monetary and fiscal stabilization, international payments, and the International Bank and Monetary Fund. *F*

BUFI 102 Introduction to Commercial Lending (4) An overview of the commercial lending function. Four sections cover commercial lending overview, the lending process, portfolio management, and regulation and business development. Specific contents include the commercial loan customer, types of commercial loans, the loan decision process, cost analysis, control and profitability, and the regulatory and legal environment. *W*

BUFI 106 Principles of Bank Operations (4) Basic course stating a history of banking, developing of Federal Reserve System; three main duties, safekeeping, transfer of funds, lending. Examination and governmental examination. Field work and problems concerning the operation of commercial bank and savings and loan institutions. *Sp*

BUFI 205 Installment Credit (4) Procedures, forms, government regulations, delinquency and collections, interest rates, background of installment credit. *W*

BUFI 240 Personal Finance (4) Takes the student through the topics of financial planning, budgeting, housing, transportation, insurance, investments, retirement, and estate planning. *Sp*

BUFI 245 Principles of Finance (4) A study of the forms of business organization, cash flow projections, budgeting and financial planning, and analysis of financial statements. *F W; req. BUAC 102 or 201, ECON 101 and 102*

BUFI 250 Introduction to Investments (4) A study of the various types of investments, including stocks, bonds, mutual funds, commercial paper, options, and commodities. Particular emphasis is given to return and risk in developing investment strategies. *W; req. BUFI 245*

BUFI 299 Special Topics in Banking/Finance (1-4) Opportunity for the student to work on special projects under the supervision of an instructor with expertise in the area of the student's project. *Not regularly offered; req. instructor permission; see special note on page 105.*

BUFI 301 Principles of Insurance (4) Basic insurance course includes the nature of risk; the legal environment; life, health, income, property liability, business risk, government, and international insurance. *F*

BUFI 310 Money and Banking (4) Cross-listed as ECON 310. Development of banking and the role of the Federal Reserve System in the U.S. Analysis of monetary policy for purpose of stabilization. *Sp; req. ECON 101 and 102*

BUFI 311 Financial Statement Analysis (4) A detailed study involving the analysis and interpretation of financial information contained in financial reports of various entities, including measurements of the firm's profitability, solvency, and degree of safety. *Not regularly offered; req. BUAC 103 or 203*

BUFI 315 Financial Institutions (4) An integrated and comprehensive analysis of financial markets and institutions emphasizing financial intermediaries and their operation in the markets. *Sp; req. ECON 102 and BUAC 102 or 201*

BUFI 345 Managerial Finance (4) An analysis of financial information for the purpose of facilitating the planning, organizing, and controlling functions of management. Includes financial statement analysis, budgeting, concepts of present and future value, cash flow analysis, and capital budgeting decisions. *F W; req. ECON 101 and 102, BUAC 103 or 203, and MATH 150*

BUFI 350 Investments (4) A study of various investment alternatives and the general and specific information that must be considered before thought is directed toward specific industries and businesses. Included is the study of the tools and sources needed for analysis in making wise investment decisions. *Sp; req. ECON 102 and BUAC 102 or 201 and BUFI 345*

BUFI 481 International Finance (4) A survey of the institutions, methods, instruments, and procedures involved in international finance, including the nature of the foreign money market, foreign legal and tax environment, and foreign subsidiary operations. *Not regularly offered; req. BUFI 345*

BUFI 499 Special Topics in Finance 2 (1-4) Opportunity for the junior or senior student to work on special projects under the supervision of an instructor with expertise in the area of the student's project. *Not regularly offered; req. instructor permission; see special note on page 105.*

Business/Health

BUHE 202 Personal and Community Health (4) Cross-listed as HPER 202. Fundamentals, practices, and appreciation of healthful living. Designed to incorporate the principles of scientific health information and promote desirable attitudes and practices in individuals, parents, and teachers. *F*

BUHE 203 Human Nutrition (4) Cross-listed as HPER 203. A study of nutrients, including sources, composition, function, and metabolism in the human body. The human life cycle is considered in planning appropriate diets. *F W Sp*

BUHE 227 First Aid (4) Cross-listed as HPER 227. Provides information and practical experience dealing with hemorrhaging, traumatic shock wounds, respiratory failure, serious illnesses, transportation of the sick and injured, cardiopulmonary resuscitation, splinting of broken bones, hypothermia, specific injuries, choke-saving, poisoning, burns, heat illnesses. Students are certified in CPR (infant and adult) through the American Heart Association. *F W Sp*

BUHE 300 Medical Terminology for Health Managers (4) Provides the vocabulary found in the health care arena, including terms related to anatomy, physiology, medical and laboratory reports as well as disease processes. Emphasis is placed on the concerns health care managers should have, based on this material. *Sp*

BUHE 310 Orientation to Health Care Systems (4) Cross-listed as AHNR 310. A broad orientation to the health services industry. Segments of the health services industry are identified and described with historical background, functions, interrelationships, and future roles of each. *F*

BUHE 311 Health Record Principles (4) Cross-listed as AHNR 311. Study of the health record, including definition, standards for content, and format. Also studied are the interactions of the health care professionals contributing to, utilizing, and analyzing health record data. *Not regularly offered; see advisor*

BUHE 312 Health Care Personnel Management (4) Cross-listed as AHNR 312. Principles of health care personnel recruitment, selection, and management. Characteristics of the professional health care worker are discussed. Legal responsibilities, collective bargaining, continuing education, and training are covered. *W*

BUHE 314 Community Health Programs (4) Provides an understanding of the various agencies in place to promote and maintain health at the community, state, and national levels. *Sp; req. BUHE 202 and 310*

BUFI 345 - BUHE 314

BUHE 360 - BUHE 499

BUHE 360 Drugs/Substance Abuse (4) Cross-listed as HPER 360, PSYC 360, and SOCI 360. An in-depth study of alcohol, tobacco, and other drugs and how chemical dependency on these drugs can affect individual performance and behavior. *Su F W Sp*

BUHE 385 Health Management Practicum (1-4) Field experience focuses on skill building in general management. Observation and experience in a variety of settings. Includes exploration of the relationship between departments and the critical need for communication within an organization. Also develops empathy for the various health care workers and support staff and their roles. *Su 10-wk, F, W, Sp as needed; preq. junior standing*

BUHE 410 Patient Care Issues in Long-Term Health Care Facilities (4) Cross-listed as AHNH 410. An overview of the total medical and social care required for residents of long-term health care facilities. Orientation to the various aspects required of the administrator and institution to provide for the total care of the individual. Topics include pharmaceutical services, disease process and recognition, biological aging, psychology of patient care, patient assessment, care planning, and nutrition. *Su 1st 5-wk 1997, W 1998, 1999*

BUHE 411 Administration in Extended Care Facilities (4) Cross-listed as AHNH 411. The role and responsibility of management as applied to a long-term health care facility. Includes discussion of ethical practices, licensure, state and federal agency requirements, and financial management. *Su 2nd 5-wk 1997, Sp 1998, 1999*

BUHE 415 Administration in Acute Care Facilities (4) Focuses on issues important to the management, organization, planning, and evaluation of health care facilities and the services rendered to patients. Emphasis on the manager's role in a health care organization, caring for individuals in non-extended care circumstances. Identification of the various departments and services available and the interaction of each. *W Su 1st 5-wk, 1998; preq. BUMG 310 and BUHE 310*

BUHE 416 Management Issues in Acute Care Facilities (4) Provides understanding of organizational behavior and management practices in non-extended health care facilities. Hands-on application of management skills and concepts. *Sp 1997, 1998, Su 2nd 5-wk 1998; preq. BUHE 310 and BUMG 310*

BUHE 420 Problems in Health Care Management and Policies (4) Cross-listed as AHNH 420. A seminar course. Health care management problems are studied and recommendations offered for the resolution of those problems. *Sp; It is recommended that this problems and policy course be taken as the last course in the health management concentration.*

BUHE 430 Health Care Finance and Reimbursement (4) Cross-listed as AHNH 430. Analysis of reimbursement and payment systems for health care related organizations such as acute care, extended care, managed care, and other alternative care groups. *F; preq. BUAC 101 and 102 or BUAC 201*

BUHE 451 Internship in Extended Health Care Management (6) Cross-listed as AHNH 451 and EDUC 451. Provides 400 hours of a structured and supervised professional experience within an approved extended health care organization. Students complete assigned projects and/or managerial tasks under joint supervision of a health care facility administrator and a university faculty member. *Su 10-wk, F W Sp as needed; preq. coursework completed and permission; \$10.00*

BUHE 452 Internship in Acute Health Care Management (6) Provides 400 hours of a structured and supervised professional experience within an approved acute health care related organization. Students complete assigned projects and/or managerial tasks under the joint supervision of a health care facility manager and a university faculty member. *Su 10-wk, F W Sp as needed; preq. coursework completed and permission; \$10.00*

BUHE 499 Seminar - Health Management Topics (1-4) Discussion of current topics in the health care arena. *Not regularly offered; preq. permission (May be repeated for a maximum of 6 hours.); \$10.00; see special note on page 105.*

Business Information Systems

- BUIS 101 Introduction to Computer Information Systems (4)** Computer theory presented via lectures as well as practical, hands-on experiences in a work setting. Introduction to topics such as computer history, hardware, software, and business applications. Introduction to the use of computer software, including MS Windows, word processing with MS Word, spreadsheets using MS Excel, and data base management using Access. *Su F W Sp; \$30.00*
- BUIS 103 BASIC Language 1 (4)** Introduction of computer programming concepts used in developing graphical user interfaces (GUIs). Pseudocode and algorithm development in problem solving are implemented. This interactive course involves the student and the computer in the development of functional programs in the Visual BASIC language. *Su F W Sp; req. BUIS 101 or BUAI 101; \$30.00*
- BUIS 104 BASIC Language 2 (4)** Advanced VISUAL BASIC programming skills are developed. The use of files and file organization methods, concepts of arrays, advance decision making, and looping techniques are studied. *F W Sp; req. BUIS 103; \$30.00*
- BUIS 105 COBOL Programming 1 (4)** In-depth study of the COBOL language. The use of files on disks, print routines, terminals, and documentation is presented. Many problems are assigned to move theory into practice. *F; req. BUIS 101; \$30.00*
- BUIS 106 COBOL Programming 2 (4)** A deeper study of COBOL. More complex problems, using tables and various utility programs. New instructions and different ways to utilize them are presented. *W; req. BUIS 105; \$30.00*
- BUIS 201 C Language (4)** Introduction to C language programming in a highly interactive course. Students write programs that utilize the new topics presented, such as arrays, pointers, and files. *Su F W Sp; req. one computer language course or sophomore standing; \$30.00*
- BUIS 202 Computer Operations Management (3)** Personnel policies, computer related management procedures, equipment acquisition, and management of resources related to computer information systems. Essential principles to effectively manage a computer system, computer personnel, and resources are examined. *W Sp; req. two programming languages and sophomore standing; \$30.00*
- BUIS 203 Business Computer Projects (4)** Research projects are assigned on both an individual and group basis. Students learn to function in a group setting as they conduct research related to the assigned topics. Theoretical systems concepts are explored in the classroom. A formal presentation is required. *W; req. sophomore standing; \$30.00*
- BUIS 204 Microcomputer Applications (4)** Advanced topics and techniques of several popular business application software packages. Word processing, spreadsheets, data base management, and presentation graphics tools are utilized. *W; req. BUAI 101 or BUIS 101; \$30.00*
- BUIS 205 Business Data Systems and Communications (4)** A study of modern data communication systems, including theory of telecommunications and communications software. Laboratory projects on LAN Administration and the Internet. *Sp; req. one computer language and sophomore standing; \$30.00*
- BUIS 206 Fortran Programming (4)** A basic course in FORTRAN, including FORTRAN arithmetic, formats, loops, arrays, program flow charting, testing, debugging, and documentation. The student is assigned several programs to solve statistical mathematics and business problems. *Not regularly offered; req. one computer language; \$30.00*
- BUIS 207 PASCAL Language (4)** An introduction to the programming language PASCAL. Some knowledge of basic algebra is helpful. Use of Input/Output statements, loops, subprograms, arrays, and files. This course is recommended for the natural science degree. *Sp; \$30.00*

BUIS 101 - BUIS 207

BUIS 208 - BULA 264

BUIS 208 RPG II Language (4) A versatile computer language frequently used by small business. All rules of programming apply, but various forms are required to produce output. An IBM AS/400 computer is used to run and compile the programs. *Sp; req. sophomore standing; \$30.00*

BUIS 299 Special Topics in Business Information Systems (1-4) Opportunity for the student to work on special projects under the supervision of an instructor with expertise in the area of the student's project. *Not regularly offered; req. instructor permission; see special note on page 105; \$30.00*

Legal Assisting

BULA 101 Introduction to Legal Assisting (4) Practical introduction to the career of paralegalism. Describes the drafting, digesting, interviewing, investigating, and research skills required to be an effective paralegal or legal assistant. *Su F W; \$10.00*

BULA 212 Real Estate Law for Legal Assistants (4) Provides the essential substantive and practical skills necessary for a legal assistant to participate effectively in real estate transactions. Introduces real property concepts and examines the component parts of a real estate transaction, including entering into the purchase contract, providing a legally sufficient description of the property, preparing the deed, addressing the property's state of title, and conducting the closing. *W; req. BULA 101; \$10.00*

BULA 251 Legal Research and Writing 1 (4) Employs a step-by-step approach in introducing students to the legal system, interpreting court opinions and applying opinions in legal writing. Emphasis is on the study of court opinions through "key fact" identification and using these facts in the application process. *Su F W Sp; req. BULA 101 and ENGL 111S; \$10.00*

BULA 252 Legal Research and Writing 2 (4) A thorough overview of legal research and writing techniques. Covers information on citing cases, finding case law, and interpreting statutes. Instructs students in computer-assisted legal research, using LEXIS. *Su F W Sp; req. BULA 251; \$30.00*

BULA 255 Environmental Law for Legal Assistants (4) Introduction to the National Environmental Policy Act, the Commerce Clause and its impact upon environmental law, the Clean Air Act, and the Clean Water Act. Environmental protection based upon economic incentives, the penalties of noncompliance, risk assessment, risk management, common law remedies, and preservation by laws restricting the development of land owned by private individuals. Students obtain a working knowledge of the basic legal principles utilized in environmental law. *Not regularly offered; req. BULA 101*

BULA 261 Tort Law: Personal Injury Litigation (4) Presents an overview of tort law oriented to paralegals. Specific skill assignments in research analysis, drafting, investigation, and interviewing. Students can relate the law outlined in the book to the specific law of a particular state. *F; req. BULA 101; \$10.00*

BULA 262 Introduction to Civil Litigation (4) An introduction to the legal system of dispute resolution in noncriminal matters. Focuses on the process of civil litigation rather than on substantive legal issues. Explains the paralegal's role in interviewing clients, drafting pleadings and pretrial motions, conducting discovery, and preparing for trial. Contains examples of actual documents drafted by paralegals. *Sp; req. BULA 101; \$10.00*

BULA 263 Introduction to Contracts and Restitution (4) Introduces the laws of contracts and restitution with emphasis on applying the concepts presented to contract analysis and formation. Chapters present the rules of law, examples of how the rules apply to facts, and problems that help students apply the rules. Cases are examined to show how the courts apply the rules. *F; req. BULA 101; \$10.00*

BULA 264 Computer Application and the Law (4) Provides students and legal professionals with the minimum knowledge about computers that they will need to work efficiently in today's automated law practice. *Su F W Sp; \$30.00*

BULA 265 Family Law (4) Comprehensive overview of family law for the nonlawyer. Practice-oriented text teaches students the skills and techniques in investigation and analysis and includes detailed coverage of child custody, contract cohabitation, property division, and support enforcement laws. *W; preq. BULA 101; \$10.00*

BULA 266 Wills, Trusts, and Estate Administration (4) A paralegal course in probate or estate administration. Contains updated tax laws and tax forms affecting wills and estates. *Sp; preq. BULA 101; \$10.00*

BULA 267 Legal Assisting Practicum (4) Students are placed in businesses where their acquired skills can be utilized and tested. This training is closely supervised by the instructor and consists of 160 hours of "hands-on" experience. *F W Sp; preq. 24 credit hours of BULA, including BULA 252; 2.0 cumulative grade point average in all coursework and in BULA; and permission of instructor; \$10.00*

BULA 268 Law Firm Procedure and Management (4) A "how-to" guide for handling all of the administrative functions and routine legal matters in a law office as efficiently and economically as possible through the proper use of non-lawyers, so that the lawyer may free his/her time for the handling of challenging legal tasks. *Not regularly offered; preq. BULA 101*

BULA 269 Criminal Law/Criminal Procedure (4) Basic elements of criminal law and procedure dealing with the interpretation and recognition of the use of the criminal code. Assistance with all aspects of the pretrial through posttrial process. This includes investigations, motions, preparation, and research. Research assignments expand the student's skills in this area. *F; preq. BULA 101; \$10.00*

BULA 270 Evidence (4) Introduces the importance of obtaining evidence through fact investigation and develops skills in discovering and organizing facts for use in litigation. *W; preq. BULA 101; \$10.00*

BULA 271 Legal/Medical Terminology and Applications (3) Introduction to the proper procedures for preparing medical reports, clinical reports, and various types of legal documents. An extensive list of medical and legal terms is utilized. This course is structured around the microcomputer. *Not regularly offered; preq. BULA 269*

BULA 272 Ethics for the Legal Assistant (4) This course gives the student a look at the ABA Code and Rules of Professional Conduct, accepted nationally as the ethical expectations for legal professionals; the case law that has developed on the Codes and Rules; and standards aimed specifically at legal assistants. *Sp; preq. BULA 101; \$10.00*

BULA 273 Debtor/Creditor Law (4) An introduction to the general provisions of the Bankruptcy Code, administration of a bankruptcy case, liquidation, reorganization, preliminary considerations necessary prior to commencing a bankruptcy case, and various remedies afforded to the debtor and creditor. *Not regularly offered; preq. BULA 101*

BULA 299 Special Topics in Legal Assisting (1-4) Individual or small-group study, under the supervision of an instructor, of topics not otherwise available to students. *Not regularly offered; preq. BULA 101; see special note on page 105; \$10.00*

Business Law

BULW 250 Business Law 1 (4) An introduction to the legal environment of business based on the uniform commercial code, including the forms and classifications of law, an overview of the court systems, court procedure, social forces and the law, torts and crimes, and the principles of contract law. *F W Sp*

BULW 260 Business Law 2 (4) Includes the study of the law covering sales, agency and employment, commercial paper, personal property, and bailments. *W Sp; preq. BULW 250*

BULW 270 The Legal Environment of Business (4) An examination of the creation and evolution of principles and rules of law, emphasizing an understanding of the court system and court procedure, the role of administrative agencies and government regulations, and the study of criminal, tort, and the substantive law of contracts. *Sp*

BULA 265 - BULW 270

BULW 299 - BUMG 312

BULW 299 Special Topics in Legal Environment (1-4) Opportunity for the student to work on special projects under the supervision of an instructor with expertise in the area of the student's project. *Not regularly offered; req. instructor permission; see special note on page 105.*

Management

BUMG 101 Introduction to Business (4) A survey course of the basic functions of American business with an emphasis on the responsibility of business as a vital segment of society. Introduction to the American economic system and the role of profits as the motivating force behind U.S. business activity. (Not open to juniors and seniors.) *F W Sp*

BUMG 210 Management Concepts (4) An introductory course in management concepts, organization, and principles with a detailed analysis of the management functions of planning, organizing, staffing, directing, and controlling. Communications, decision making, and motivation are emphasized as integral concepts in performing the management functions. *Su F W Sp*

BUMG 225 Organization and Operation of Small Business (4) A course designed to provide the basics of small business: getting started, financial recordkeeping, cash flow management, computers, human resource management, marketing, pricing, advertising, and promotion. *F*

BUMG 235 Personnel Management (4) The philosophy, principles, and methods of personnel management stressing human resource planning, recruiting, selection, placement, training, evaluation, wage and salary administration, and benefit programs. *W Sp*

BUMG 240 Labor Relations (4) Topics related to collective bargaining, contract or labor agreements, workers' compensation laws, apprentice training, and jurisdictional disputes. *W; req. BUMG 210 or permission*

BUMG 242 Business Communications (4) Principles and techniques of effective letter writing, letter mechanics, writing of personal business letters, including application letters, methods of writing business reports and letters, and internal and external reports as a means of communication. *F W Sp; \$30.00*

BUMG 285 Enterprise Management and Strategy (4) An integrative course that enables students to demonstrate the capacity to synthesize and apply the knowledge and skills acquired from the various disciplines in business, social sciences, and humanities; to analyze case problems; and to develop and effectively communicate a comprehensive business project. *Sp; req. 60 hours completed toward the associate degree, including BUAC 102 or 203, BUMK 210, BUMG 210, 242, and BUFI 245*

BUMG 290 Seminar in Small Business Problems (4) A course designed to acquaint the student with actual small business problems; structured through the Small Business Institute of the Small Business Administration and classroom case studies. *Not regularly offered; req. BUMG 225*

BUMG 299 Special Topics in Small/General Business (1-4) Opportunity for the student to work on special projects under the supervision of an instructor with expertise in the area of the student's project. *Not regularly offered; req. instructor permission; see special note on page 105.*

BUMG 310 Management Principles (4) A study of the fundamental principles of management emphasizing the managerial functions, basic concepts of systems, decision making processes, organizational theory and behavior, and its effect on management. *F; req. BUAC 203, ECON 101, and 102*

BUMG 312 Purchasing and Materials Management (4) A complete exposition of the purchasing/materials management function in all types of profit and not-for-profit organizations. Emphasizes the purchasing decision process and the management of that activity. *Not regularly offered; req. BUMG 310*

BUMG 320 - BUMG 410

BUMG 320 Data Analysis (4) Computer assisted statistical analysis using SPSS or current statistical application software as a research tool. In-depth use of computer applications for research, emphasizing statistical procedures, graphic design, and interpretation of results. Applications appropriate to business, social and physical sciences, psychology, and education. Special projects to suit student's needs. *W*; *req.* MATH 150 or BUMG 355 (*Suggestion: This course should be taken before BUMG 330.*); \$30.00

BUMG 330 Organizational Communication (4) A study of the communication demands and skills relevant to the student's future role as a business or professional person. Organizational communication focuses on principles and techniques involved in organizing ideas, writing effective business letters and reports, and oral communication. Applications with computer assisted statistical analysis and graphic design used to enhance business reports. *F Sp*; *req. junior standing*; *req.* MATH 150 or BUMG 320; \$30.00

BUMG 331 Business Ethics (4) Cross-listed as PHIL 331. Examination of the relationship between economic and moral constraints. *Su F W Sp*; *req.* ENGL 1155

BUMG 332 Managerial Economics (4) Cross-listed as ECON 332. Use of economic theory and decision making techniques in business management. Production and consumer theory, applied price theory, pricing of final products, theory of profits, profit management, capital budgeting, cost and demand analysis theory to provide a solid foundation of economic understanding for use in managerial decision making. *Not regularly offered*; *req.* ECON 101, 102, and MATH 190.

BUMG 335 Human Resource Management (4) Principles and practices of recruiting, selecting, training, developing, compensating, and maintaining a productive employee group through systematic human resource management planning consistent with government regulations. Includes attention to grievance and disciplinary procedures and collective bargaining. *Not regularly offered*; *req.* BUMG 310 or permission

BUMG 340 International Business (4) Introduces students to international business by exploring a broad spectrum of business activities. Competitive strategy provides the unifying theme. *F Sp*

BUMG 355 Quantitative Methods in Business (4) A study of the quantitative tools and techniques applied to business decision-making. The primary tool investigated is the linear regression model. Includes forecasting, multiple regression, qualitative variables, and the analysis of residual patterns. Also explores the linear programming model. Models are explained graphically, calculated manually, and then explored more fully on the computer. *F Sp*; *req.* MATH 150 and 170 and BUAI or BUIS 101; \$30.00

BUMG 370 Operations Research 1 (4) Cross-listed as MATH 370. An introduction to the general nature, history, and philosophy of operations research. A study of the theory of linear programming, the simplex algorithm, and applications. A series of special linear programming problems, such as optimal assignment, transportation, transshipment, network flow, minimal spanning trees, shortest path, PERT methods, and traveling salesperson. *W 1999*; *req.* MATH 230 or BUMG 355 or instructor consent

BUMG 371 Operations Research 2 (4) Cross-listed as MATH 371. A continuation of BUMG 370. Dynamic programming and integer programming are studied (or finished if started in BUMG 370). Stochastic models of operations research such as markov chains, queuing theory, and simulation are studied. *Sp 1999*; *req.* BUMG 370 and MATH 150 or instructor consent

BUMG 385 Production/Operations Management (4) An overview of production and operations management, including procedures and techniques generally employed in both manufacturing and nonmanufacturing organizations. Topics include forecasting, line balancing, PERT, MRP inventory systems, layout planning, and capacity planning. Extensive use is made of computers. *Su W*; *req.* BUMG 355; \$30.00

BUMG 410 Business Simulation (4) Explores the analysis of business problems using computer simulations. Outcomes resulting from various inputs are projected and interpreted to aid in decision making. *Su W*; *req.* BUMG 355 and MATH 170; \$30.00

BUMG 485 - BUMK 325

BUMG 485 Business Policy and Strategy (4) A case-oriented course designed to develop skills in the integration of interdisciplinary areas as applied to problems in business. Includes both written and oral presentation of case problems. *W Sp; req. BUFI 345 and BUMG 385, senior standing*

BUMG 499 Special Topics in Management (1-4) Opportunity for the junior or senior student to work on special projects under the supervision of an instructor with expertise in the area of the student's project. *Not regularly offered; req. instructor permission; see special note on page 105.*

Marketing

BUMK 103 Introduction to Retailing (4) Principles and methods of retail management, including organization, policy making, location, operation, selling services, records, inventory, expense control, insurance, and the coordination of a retail business. *W*

BUMK 210 Marketing Concepts (4) A study of marketing fundamentals, consumption, consumer behavior, retailing, wholesaling structures, the functions performed in marketing, marketing policies, and a critical appraisal of the field of marketing. *F W*

BUMK 220 Salesmanship (4) Basic concepts of personal selling at both the industrial and retail level, including preparation for selling, sales processes, and an introduction to sales management. Emphasis on retail selling, with a discussion of career opportunities. *W*

BUMK 225 Marketing Case Studies (4) Discussion of marketing problems in a group situation. Problems include marketing management, production planning and development, marketing research, industrial buying behavior, market segmentation, price objectives, advertising, and international marketing environment. *F; req. BUMK 210 or 310; Not open to students who have credit for BUMK 400.*

BUMK 235 Advertising (4) A study of the principles of advertising, including the history and development of advertising, its relation to the marketing effort of the firm and to consumers and society in general, and the major groups of media used by the advertiser. *Sp*

BUMK 239 Practical Business Applications (1-4) Student participates in an off-campus work experience with a business specializing in the student's area of interest. One credit hour is awarded for a minimum of seven scheduled clock hours of such activity per standard work week. *Not regularly offered; req. advisor permission*

BUMK 299 Special Topics in Retailing/Sales/Advertising (1-4) Opportunity for the student to work on special projects under the supervision of an instructor with expertise in the area of the student's project. *Not regularly offered; req. instructor permission; see special note on page 105.*

BUMK 310 Marketing Principles (4) A study of the marketing principles, concepts, strategies, and analytical methods used by organizations to market products, services, and ideas in dynamic environments. Emphasis on identifying marketing opportunities, defining target groups, developing appropriate products, promotion distribution, and pricing strategies. *W*

BUMK 315 International Marketing (4) Directed at developing skills to make marketing decisions in a global context. This includes finding new markets, customizing products for the demands of new markets, determining needs, channels of distribution, pricing strategies, and segmentation. *Not regularly offered; req. BUMK 310*

BUMK 320 Sales Management (4) The principles and practices of planning, organizing, motivating, and controlling the sales force. Selection, training, compensation, analysis of sales potentials, and costs are also covered. *Not regularly offered*

BUMK 325 Marketing Research (4) Techniques involved in the collection, tabulation, and analysis of marketing information. Includes statistical procedures and their marketing application, brand positioning, and market segmentation using marketing research techniques. *Not regularly offered; req. BUMK 310 and MATH 150; \$30.00*

BUMK 400 - BUOA 230

BUMK 400 Marketing Management (4) A strategic focus on marketing management with a solid application of basic marketing concepts. Concentrates in the areas of decision making, competitor analysis, formulating a marketing plan, forecasting, and planning. *Not regularly offered; req. BUMK 310*

BUMK 499 Special Topics in Marketing (1-4) Opportunity for the junior or senior student to work on special projects under the supervision of an instructor with expertise in the area of the student's project. *Not regularly offered; req. BUMK 310 and instructor permission; see special note on page 105.*

Office Administration

BUOA 108 Beginning Document Processing (4) A study of the touch system of keyboarding at the microcomputer as well as an introduction to WordPerfect word processing software. *F W Sp; \$30.00*

BUOA 109 Intermediate Document Processing (4) Continuation of BUOA 108 with application of basic keyboarding techniques to the production of letters, reports, and memorandums on the microcomputer using WordPerfect software. *Su F W Sp; req. BUOA 108; \$30.00*

BUOA 110 Advanced Document Processing (4) Application of WordPerfect 6.1 for Windows keyboarding and document processing skills to "real work" situations. *W Sp; req. BUOA 109; \$30.00*

BUOA 111 SuperWrite 1 (4) Introduction to reading and writing of SuperWrite, an alphabetical writing system, and the development of transcription skills which include vocabulary development, spelling, punctuation, and grammar. *F; \$30.00*

BUOA 112 SuperWrite 2 (4) Continuation of BUOA 111. Students are encouraged to master the use of transcription equipment and apply rules of punctuation and grammar. *W; req. BUOA 111; \$30.00*

BUOA 130 Records Management (4) Designed to emphasize the principles and practices of effective records management for manual, automated, and computer records systems. The ARMA alphabetic indexing rules are applied. *F; \$30.00*

BUOA 214 Microcomputer Office Practice (4) A brief overview of Microsoft Office 4.3 software with emphasis on Access 2.0 for Windows and PowerPoint 4 for Windows. *F; req. keyboarding skills and basic knowledge of microcomputers; \$30.00*

BUOA 215 Lotus 1-2-3 (4) An introduction to Lotus 1-2-3 Release 5 for Windows. *Su W Sp; req. keyboarding skills and basic knowledge of microcomputers; \$30.00*

BUOA 217 Office Computer Applications (4) A brief overview of Microsoft Office 4.3 software with emphasis on Word 6.0 for Windows and Excel 5.0 for Windows. *Sp; req. keyboarding skills and basic knowledge of microcomputers; \$30.00*

BUOA 221 Word Processing 1 (4) Word processing concepts and skills are presented to the person with no previous training in word processing. WordPerfect 6.1 for Windows software is used. *Su F W; req. keyboarding skills and basic knowledge of microcomputers; \$30.00*

BUOA 222 Word Processing 2 (4) Continuation of BUOA 221 with more advanced applications of the WordPerfect 6.1 software. *W Sp; req. BUOA 221; \$30.00*

BUOA 223 Word Processing 3 (4) A continuation of BUOA 222 using the specialized office application features of WordPerfect 6.1 software which includes desktop publishing. *F Sp; req. BUOA 222, \$30.00*

BUOA 230 Desktop Publishing 1 (4) An introduction to the PageMaker 5.0 desktop publishing software program. *Sp; req. basic knowledge of microcomputers; \$30.00*

BUOA 231 - BURE 215

BUOA 231 Desktop Publishing 2 (4) Continuation of BUOA 230, with more advanced applications of the PageMaker 5.0 desktop publishing software program. *Su; req. BUOA 230; \$30.00*

BUOA 241 Office Administration 1 (4) Introduction to the responsibilities and opportunities of an office administration position encompassing a variety of secretarial duties. Lab work is completed on a microcomputer. *F; req. BUOA 110 and 222; \$30.00*

BUOA 242 Office Administration 2 (4) A continuation of BUOA 241, including assisting with travel arrangements, planning meetings, presenting business data, and handling financial procedures. *W; req. BUOA 223 and 241; \$30.00*

BUOA 244 Medical/Legal Office Administration (4) Introduction to the proper procedures for preparing general medical documents and various types of legal documents using a microcomputer. Medical and legal terms and their correct usage in documents is emphasized. *W; req. BUOA 223; \$30.00*

BUOA 250 Office Administration Internship (1-4) Student participates in on-the-job work experience which allows the utilization of office administration skills. One credit hour is awarded for a minimum of seven scheduled clock hours of work per standard work week. *Not regularly offered; req. internship availability and approval; completion of at least 4 quarters of the office administration program with a "B" average in all BUOA classes; advisor permission*

BUOA 299 Special Topics in Office Administration (1-4) Opportunity for the student to work on special projects under the supervision of an instructor with expertise in the area of the student's project. *Not regularly offered; req. instructor permission; see special note on page 105; \$30.00*

Real Estate

BURE 101 Real Estate Mathematics Applications (3) Designed to provide the mathematical skills and background necessary for a real estate salesperson, broker, appraiser, or property manager. Topics include commissions, points, mortgage interest and principal, real estate taxes, prorating, investment analysis, and percentage leases. *Not regularly offered*

BURE 210 Real Estate Principles and Practices (4) Introduction to real estate economics and administration. Includes elementary physical, legal, locational, and economic characteristics of real estate; real estate markets; and national, regional, and local economic influences on real estate values. Serves as a preparation for securing a license. *F*

BURE 212 Real Estate Law (4) Includes the law of agency as applied to real estate brokers and salesmen, law of fixtures, estates (including leases), conveyancing of real estate, real estate managers, license laws of Ohio, zoning, cooperatives, and condominiums. *F*

BURE 213 Real Estate Finance (4) Includes the nature and characteristics of mortgage loans, government influence on real estate finance, the mortgage market, and the effects of monetary and fiscal policies on real estate financing. Concepts and measurements of value, cash flow, leverage, and tax shelters are emphasized. *Sp*

BURE 214 Real Estate Appraisal (4) Emphasizes the methodology of appraising urban real property and the theory underlying appraisal techniques. In-depth study of market comparison, penalized cost of replacement, and income capitalization. A term project provides practical experience in applying these techniques. *W*

BURE 215 Real Estate Brokerage (4) Basics of real estate economics, brokerage, and administration. Designed for the professional development of real estate personnel and for those who are not in the real estate business but who wish to increase their general knowledge. *Not regularly offered*

BURE 299 Special Topics in Real Estate (1-4) Opportunity for the student to work on special projects under the supervision of an instructor with expertise in the area of the student's project. *Not regularly offered; req. instructor permission; see special note on page 105.*

Chemistry

CHEM 101 Fundamental Chemistry (4) A course designed for students with an inadequate background in chemistry or students who have not had high school chemistry. Topics and material presented are intended to increase student's familiarity with the periodic table, chemical processes, and chemical calculations. *Su F W Sp; req. one year of high school algebra or MATH 101*

CHEM 121 Introduction to General Chemistry 1 (4) An introductory course in fundamental concepts of chemistry for nonscience majors. Topics include atomic structure, compound formation, chemical equations, stoichiometry, and inorganic nomenclature. Credit allowed for only one of these introductory courses: CHEM 101, 121, or 141. *F W; req. one year of high school chemistry or CHEM 101 or successful completion of MATH 130; 3 lec. 3 lab; \$20.00*

CHEM 122 Introduction to General Chemistry 2 (4) An introduction to gases, the properties of solutions, reactions in solution, acids and bases, equilibrium, oxidation-reduction reactions. Credit not allowed for both CHEM 122 and 142. *W Sp; req. CHEM 121 or permission; 3 lec. 3 lab; \$25.00*

CHEM 141 General Chemistry 1 (4) An introduction to chemistry through the study of fundamental chemical concepts, inorganic nomenclature, periodic classification, mole concept, stoichiometry with problem solving, ionic reactions, gas laws, and thermochemistry. Credit not allowed for both CHEM 121 and 141. *F W; req. one year of high school chemistry or CHEM 121 and placement in MATH 130; 3 lec. 3 lab; \$25.00*

CHEM 142 General Chemistry 2 (4) An introduction to atomic structure, chemical bonding, molecular geometry, properties of liquids and solids, solutions, and acid-base theories. *W Sp; req. CHEM 122 or 141 and MATH 130 or above; 3 lec. 3 lab; \$25.00*

CHEM 143 General Chemistry 3 (4) An introduction to chemical thermodynamics, kinetics, chemical and ionic equilibria, oxidation-reduction reactions, equivalence, and electrochemistry. *F Sp; req. CHEM 142 and MATH 131 or above; 3 lec. 3 lab; \$25.00*

CHEM 200 Introduction to Organic Chemistry (4) A course in fundamental organic chemistry. The study of the major functional groups: saturated and unsaturated hydrocarbons, alcohols and ethers, aldehydes and ketones, carboxylic acids, amines, carboxylic acid derivatives. The organic chemistry of carbohydrates, lipids, and proteins. *Sp; req. CHEM 121 or 141; 3 lec. 3 lab; \$25.00*

CHEM 240 Introduction to Environmental Science (4) Cross-listed as NTSC 240. Survey of the nature and scope of environmental problems. Emphasis on the physical, biological, and human aspects of environmental science. *F; req. sophomore standing with coursework in the basic sciences, BIOL 151, CHEM 143, or GEOL 201; 3 lec. 2 lab; \$22.00*

CHEM 305 Organic Chemistry 1 (4) A course for science majors wishing to acquire a sound knowledge of classical and modern organic chemistry. Credit not allowed for both CHEM 200 and 305. *F; req. or coreq. CHEM 143; 3 lec. 3 lab; \$25.00*

CHEM 306 Organic Chemistry 2 (4) Continuation of CHEM 305. *W; req. CHEM 305; 3 lec. 3 lab; \$25.00*

CHEM 307 Organic Chemistry 3 (4) Continuation of CHEM 305 and 306. *Sp; req. CHEM 306; 3 lec. 3 lab; \$25.00*

CHEM 323 Quantitative Analysis (5) An introduction to methods of chemical analysis. Topics include statistics, equilibria, volumetric analysis, and an introduction to instrumental analysis. *W alternate years; req. CHEM 143 and MATH 132; 3 lec. 6 lab; \$25.00*

BURE 299 - CHEM 323

CHEM 325 - CHEM 499

- CHEM 325 Instrumental Analysis (5)** The use of electronic instrumentation (spectroscopic, chromatographic, and electrochemical) for chemical analyses. *Sp alternate years; preq. CHEM 323; 3 lec. 6 lab; \$30.00*
- CHEM 331 Introduction to Physical Chemistry (4)** Survey of thermodynamics, kinetics, gas laws, quantum mechanics, and spectroscopy. *F alternate years; preq. PHYS 213 or permission*
- CHEM 341 Introduction to Inorganic Chemistry (4)** A descriptive study of how the variations in chemical reactivities of the elements and their compounds relate to trends in periodic properties such as atomic radius and electronegativity. Topics include solubility of salts, redox reactions, coordination chemistry, the HSAB principle, and crystal structures of ionic solids. Hydrated cations, oxo anions, and simple organometallic compounds are covered. *W alternate years; preq. CHEM 143; 3 lec. 3 lab; \$25.00*
- CHEM 350 Literature and Information Retrieval (2)** A course in the use of printed indexes, computerized data bases, and standard references for chemical information retrieval. Development of search strategies and assessment of retrievals are reinforced through library assignments, including a librarian-assisted online search of Chemical Abstracts. *F, alternate years; preq. or coreq. CHEM 307*
- CHEM 411 Biochemistry (4)** Cross-listed as BIOL 411. General principles of the structural and functional properties of carbohydrates, lipids, nucleic acids, and proteins. This course can be counted as a concentration area in biology or chemistry. *Preq. CHEM 307; 4 lec.*
- CHEM 421 Environmental Chemistry 1 (4)** Topics include the atmosphere, stratospheric ozone, tropospheric chemistry, indoor air quality, and natural waters. *W alternate years; preq. CHEM 143; 3 lec. 3 lab; \$30.00*
- CHEM 422 Environmental Chemistry 2 (4)** Topics include acid rain, drinking water, sewage and waste disposal, chlorine and chlorinated organic compounds, and metals in the environment. *Sp alternate years; preq. CHEM 421; 3 lec. 3 lab; \$30.00*
- CHEM 432 Physical Chemistry 1 (4)** Topics include equilibrium, liquids, solids, spectroscopy, etc. Application of experimental principles to lecture theory. A bridge course between chemistry and physics. *W alternate years; preq. CHEM 331; 3 lec. 3 lab; \$25.00*
- CHEM 433 Physical Chemistry 2 (4)** Topics include thermodynamics, kinetics, quantum mechanics, and areas of recent research advances (e.g. semiconductors). *Sp alternate years; preq. CHEM 432; 3 lec. 3 lab; \$25.00*
- CHEM 441 Inorganic Chemistry (4)** A theoretical study of the dependence of periodic variations in elemental properties (atomic radius, first ionization enthalpy, electronegativity, and oxidation number) on quantum mechanical factors such as electron orbital shape. Topics include symmetry and group theory and a study of bonding using both VSEPR and MO approaches. *Sp, alternate years; preq. CHEM 341; coreq. CHEM 433*
- CHEM 485 Senior Project (1-4; maximum 4)** In-depth study of a selected topic in chemistry, culminating in the preparation of a senior paper. *F W Sp; preq. senior standing and instructor permission; \$15.00*
- CHEM 490 Seminar in Chemistry (1-4; maximum 4)** Study of a specific advanced topic in chemistry. *As needed; preq. junior or senior standing and instructor permission*
- CHEM 495 Undergraduate Research (1-4; maximum 9)** Independent chemistry investigation under the direction of a faculty member. A written report is required. *As needed; preq. senior standing, 2.75 grade point average in chemistry, and instructor permission; \$30.00*
- CHEM 499 Special Topics in Chemistry (1-4)** The study of topics not otherwise available to students. *As needed*

DTHY 101 - DTHY 203

Dental Hygiene

DTHY 101 Radiology 1 (2) Didactic instruction in dental radiology. Topics include: characteristics of radiation, components and functions of the x-ray machine, and x-ray production. Emphasis on exposure factors and their effects on radiographs, effects of radiation exposure, and radiation protection. Dental x-ray films and film processing are also covered. *W*

DTHY 102 General and Oral Histology and Embryology (2) Study of the development of tissues and structures from a histological and embryological basis. Emphasis on development of tissues of the teeth and the periodontal supporting structures. *W; preq. BIOL 101*

DTHY 103 Nutrition (3) The principles of basic human nutrition with emphasis on nutritional diets and their relation to general and oral health. The study of valid nutritional information and healthful food selection. *F*

DTHY 111 Oral Anatomy 1 (3) A study of tooth form, function, and occlusion, including the supporting tissues of the teeth and oral environment. Emphasis on dental vocabulary, terminology, and the relationship of the permanent and deciduous dentition to clinical dental hygiene. *F*

DTHY 112 Oral Anatomy 2 (2) Detailed study of the anatomy of the head and neck. Topics include facial bones, muscles of the head and neck, nerve supply, and blood supply. Detailed study of the topographical and functional anatomy of the oral cavity and pharynx. *W; preq. DTHY 111*

DTHY 113 Radiology 2 (2) Continuation of DTHY 101. Emphasis on radiographic technique through lecture and lab experiences. Lab experiences include bisection of the angle and paralleling techniques as well as extra-oral radiographs on training models. Students process and mount film, as well as learn to recognize processing and technical errors, normal anatomical landmarks, and pathology. *Sp; preq. DTHY 101; \$15.00*

DTHY 121 Clinical Dental Hygiene 1 (4) Introduction to the profession and history of dental hygiene. The principles of preventive dentistry regarding etiology of deposits, caries, inflammation, and oral physiotherapy methods. Aseptic techniques are outlined. Basic instrumentation principles are demonstrated on typodonts followed by demonstration on partners. *F; \$25.00*

DTHY 122 Clinical Dental Hygiene 2 (4) Continuation of DTHY 121. Clinical skills include intra/extra oral examinations, dental/periodontal charting, scaling and polishing techniques, periodontal probing, and fluoride techniques. Skills are transferred from typodont to partner. *W; \$25.00*

DTHY 123 Clinical Dental Hygiene 3 (5) Continuation of DTHY 122. Techniques for dental hygiene care are performed in clinical patient treatment. Advanced skills include desensitization techniques, instrument sharpening, sequencing and planning patient treatment, and methods of motivating to prevent oral disease. *Sp; \$10.00*

DTHY 201 General and Oral Pathology (3) An introduction to pathology. Discussion of processes of inflammation, necrosis, retrograde changes, and wound healing. Etiologies, diagnosis, treatment, and prognosis of oral lesions. Pathology of diseases affecting teeth and their supporting structures. *F; preq. BIOL 101 and 162*

DTHY 202 Periodontics (3) A study of the periodontal supporting structures of the teeth. Etiologies and classifications of periodontal disease are discussed. The treatment of periodontal disease is discussed in relation to the etiologies. *Sp*

DTHY 203 Dental Materials (3) Didactic and laboratory instruction on the physical properties of materials used in dentistry. Basic principles of the preparation and use of certain restorative materials, impression materials, and laboratory procedures, including chemical sealants, preliminary impressions, and study models. *Su; \$20.00*

DTHY 204 - ECON 302

DTHY 204 Pharmacology and Anesthesiology (3) Drugs and anesthetics used and encountered in dentistry. Discussion of the origin, physical and chemical properties, effects on body systems, indications and contraindications for use, and methods of administration and elimination. *W; req. AHR 103 or CHEM 121*

DTHY 205 Dental Health Education (3) Analysis of goals for the development of dental health education programs. Major emphasis is on preparation and use of lesson plans and instructional materials for teaching groups. Involves classroom instruction of dental health in public schools. *Su*

DTHY 206 Public Health (3) An introduction to the broad field of public health with emphasis on dental public health. A basic approach for designing and implementing a public dental health program to promote dental health and prevent dental diseases in the community. *W*

DTHY 220 Oral Microbiology/Immunology (3) A study of general microbiology as applied to oral disease and immunity. An in-depth study of ecology of the oral flora in health and disease. Applied microbiology principles are used in topics of sterilization and asepsis. *Sp; req. BIOL 101 and 162*

DTHY 224 Clinical Dental Hygiene 4 (5) Continuation of DTHY 123. Techniques and procedures of dental hygiene care and services performed in the clinic atmosphere as they would be in practice. Lecture topics concern medical emergencies in the dental office. *Su; \$15.00*

DTHY 225 Clinical Dental Hygiene 5/Special Needs (5) Continuation of DTHY 224. Dental hygiene clinical practice includes applied nutrition as it relates to current concepts in preventive dentistry for the dental hygienist. *F; \$15.00*

DTHY 226 Clinical Dental Hygiene 6/Preventive Dentistry and Jurisprudence (5) Continuation of DTHY 225 with emphasis on prevention and trial state board patients. Ethics, jurisprudence, state laws, malpractice, and professional organizations are discussed as they relate to the dental hygiene profession. Career placement is investigated. *W; \$15.00*

DTHY 227 Clinical Dental Hygiene 7/Career Management (5) Continuation of DTHY 226. Complete dental hygiene care involving the use of advanced skills and techniques learned in previous dental hygiene courses. Special needs patients are discussed. Selected topics through seminars and lectures are presented to aid professional growth. *Sp; \$15.00*

DTHY 290 Seminar in Advanced Periodontics (1-3) Current concepts regarding nonsurgical treatment of periodontal disease. Major emphasis is placed on assessment of root planing techniques and maintenance and care of patients with periodontal disease. *Su; req. DTHY 202 or permission of the program director*

DTHY 299 Topics in Dental Hygiene (1-4) A study of topics not otherwise available to students.

Economics

ECON 101 Principles of Macroeconomics (4) An introduction to the elementary principles of macroeconomics. Includes a study of the economic system and an analysis of national income concepts, fiscal and monetary policies, and economic growth. *Su F W Sp*

ECON 102 Principles of Microeconomics (4) An elementary analysis of the principles of microeconomics. Includes a study of consumer behavior, different types of products and resource markets, and an analysis of certain economic problems. *F W Sp*

ECON 301 Intermediate Microeconomics (4) A study of the economic theories of the consumer and the firm. Analysis of price and output behavior under various product and market structures and resource market analysis. *W even years; req. ECON 101 and 102*

ECON 302 Intermediate Macroeconomics (4) National income analysis; fiscal and monetary policies for economic stabilization. *W odd years; req. ECON 101 and 102*

ECON 310 - EDUC 110

- ECON 310 Money and Banking (4)** Cross-listed as BUFI 310. Development of banking and the role of the Federal Reserve system in the U.S. Analysis of monetary policy for purpose of stabilization. *F odd years; preq. ECON 101 and 102*
- ECON 320 History of Economic Thought (4)** Evolution of economic thought and methods, with emphasis on the theories and ideas of the mercantilists, the physiocrats, the classicals, the neoclassicals, the Marxists, the Keynesians, and other schools of thought. *Not regularly offered; preq. ECON 101 and 102*
- ECON 326 Economic History of the U.S. (4)** Cross-listed as HIST 326. Analysis of the changes in the economic structure and development of the U.S. from colonial days to the present. Includes a survey of American economic life and the role of entrepreneurship in economic development. *F even years; preq. ECON 101 and 102*
- ECON 332 Managerial Economics (4)** Cross-listed as BUMG 332. Use of economic theory and decision making techniques in business management. Production and consumer theory, applied price theory, pricing of final products, theory of profits, profit management, capital budgeting, cost and demand analysis theory to provide a solid foundation of economic understanding for use in managerial decision making. *Not regularly offered; preq. ECON 101, 102, and MATH 201.*
- ECON 350 Labor Economics (4)** Economic analysis of labor markets. Topics include labor supply and the derived demand for labor, human capital theory, labor market structures, trade unions, discrimination, and public policy toward labor. *Not regularly offered; preq. ECON 101 and 102*
- ECON 405 Economic Development (4)** Analysis of economic problems and prospects for development in general and of less developed nations in particular. *Offered as demand indicates; preq. ECON 101 and 102*
- ECON 411 Comparative Economic Systems (4)** An analysis of the different economic systems: capitalism, socialism, communism, and mixed systems. Survey of the differences and similarities of the economic institutions among these systems. *Sp odd years; preq. ECON 101 and 102*
- ECON 425 Public Finance (4)** Economic analysis of government finance theory and practice. Topics include the role of government in the allocation of resources and the distribution of income, the selection of alternate expenditure and tax schemes and their effects on the private sector, and public choice theory. *Not regularly offered; preq. ECON 101 and 102*
- ECON 450 International Trade (4)** Theoretical framework of international trade; problems and policies for free trade; roles of international institutions. *Sp even years; preq. ECON 101 and 102*
- ECON 480 Econometrics (4)** Economic analysis using linear regression techniques. Emphasis is on particular problems facing applied econometric researchers and practical solutions. Computer applications are included throughout the course. *Not regularly offered; preq. ECON 101 and 102 and MATH 250*
- ECON 499 Special Topics in Economics (1-4)** Individual or small-group study, under the supervision of instructor, of topics not otherwise available to students. Repeatable for credit. *Preq. ECON 101 and 102*

Education

- EDUC 110 The Teacher as an Inquiring Professional 1: Strategies for Observation and Reflection (4)** An introduction to an explicit concept of teaching. The cycle of plan/act/observe/reflect is developed. An introduction to norms, conventions, expectations, and rewards for teachers. The distinctive nature, scope, sequence, and demands of Shawnee State University's program are outlined. *F W Sp; \$25.00*

EDUC 150 - EDUC 322

EDUC 150 Educational Communication (2) Focuses on the ability to communicate in written and oral format on current educational topics. Diagnostic or formative evaluation assess strengths and weaknesses. Frequent feedback provides opportunity to make adjustments. Offered through the Department of Teacher Education in support of the English department initiative for writing across the curriculum. *On demand*

EDUC 210 The Teacher as an Inquiring Professional 2: Strategies for Action Research (4) Introduction to specific theories of action research, beginning with the use of simple data collection instruments in field settings (classrooms) and analysis in response to an individually selected research question. Work culminates in a formal, brief research paper. Students also work with individual elementary students in tutoring sessions and are required to record their efforts, the results, and offer a professional self-evaluation on their first direct teaching experience. *F W Sp; preq. EDUC 110; \$25.00*

EDUC 220 Social/Physical/Intellectual Growth and Development (3) Students engage in a personal dialogue through journal responses to the text, to video tapes on family dynamics, to audio cassettes on high self-esteem, and through personal commentaries in class. *F W Sp; preq. EDUC 110*

EDUC 230 Instructional Media, Technology, and Computers (4) A study of how media can be used both instructionally and to observe and reflect on practice. Operation of media, production of instructional aids, and selection of media appropriate to particular instructional strategies and objectives. *F W Sp; preq. EDUC 110; \$15.00*

EDUC 240 Foundations and Competing Epistemologies 1 (3) Examines the history of education in the U.S. as well as contemporary views of the relationship between school and society. *F W Sp; preq. EDUC 110; \$25.00*

EDUC 265 Teaching Individuals in a Pluralistic Society (4) Examination of the diverse microcultures that characterize today's student population. Examines areas of exceptionality, the laws regarding exceptional learners, inclusion of exceptional learners in the regular classroom, and adaptations in the classroom environment, instructional strategies, and evaluation procedures for exceptional learners. Instructional units are designed and adapted for exceptional learners. The course also acquaints students with various approaches to multicultural education and the underlying conceptual frameworks. *F; preq. EDUC 110*

EDUC 295 Independent Study (1-4) Exploration of special topics not included in the standard curriculum. *F W Sp; \$25.00*

EDUC 310 The Teacher as an Inquiring Professional 3: Measurement, Diagnosis, and Evaluation (5) Examines a wide range of diagnostic, formative, and summative evaluation techniques to be used as an integral part of the teaching/learning process. The emphasis is on selection and utilization of appropriate evaluation for individual learners. *F W Sp; preq. admission to teacher education program; \$25.00*

EDUC 312 Literacy Foundations (4) Designed for inservice teachers who are already teaching in classrooms and are pursuing the Department of Teacher Education's Reading Endorsement. Integrated approach to the teaching of literacy (oral language, reading, writing, and literature). Introduction to literacy acquisition with a focus on interdisciplinary methods. Inquiry and teaching practice focus on reading.

EDUC 321 Advanced Developmental Reading (4) Designed to provide preservice/inservice teachers with the foundational knowledge of reading process, emergent literacy, and the principles underlying effective, holistic literacy instruction.

EDUC 322 Teaching of Writing for Elementary/Secondary Educators (4) Process-oriented course designed to provide preservice and/or inservice teachers with in-depth treatment of the theoretical and practical knowledge base on the teaching of writing to children in elementary school settings. Grounded in current child development and literacy theories, this course builds on the foundational principles of literacy acquisition.

EDUC 323 - EDUC 420

EDUC 323 Adolescent Literature (4) Cross-listed as ENGL 323. A survey and methods course designed to give secondary and middle school level preservice teachers experience in the range, quality, genres, and styles of literature suitable for use in classrooms. The course also offers experience in curriculum design, instructional deliveries, evaluation, and recordkeeping, as well as field-based practice with students in grades seven through twelve. \$25.00

EDUC 324 Critical Reading in the Content Areas (4) Final content class to complete the Teacher Education Reading Endorsement. Designed to acquaint preservice and inservice teachers with the elements of critical reading, the process of reading content material, and methods of teaching and supporting learners in reading content material.

EDUC 325 Instructing Adults (3) Cross-listed as AHNR 325. Study of adult learning needs and participation patterns. Teaching styles and techniques best suited to adults are analyzed and demonstrated.

EDUC 327 Methods of Teaching in Health and Occupations (3) Cross-listed as AHNR 327. The subject matter and teaching methodologies of health instruction in classrooms, laboratories, and community settings are analyzed and demonstrated.

EDUC 330 Communication Across the Curriculum (4) Introduction of techniques for integrating multiple avenues of communication. Students use strategies for reading, writing, speaking, and expressive arts (verbal and nonverbal) and explore a wide range of activities in each area. Students design, deliver, and evaluate projects based on rich curriculum resources. *W; preq. admission to teacher education program*

EDUC 340 Foundations and Competing Epistemologies 2 (3) Examines the ethical dimensions of teaching. Foundational knowledge regarding ethics is used to discuss moral issues which commonly occur in schools. Methods of teaching moral education in the classroom are also explored. *F W Sp; preq. EDUC 240 and admission to teacher education program; \$25.00*

EDUC 350 Computers in Instruction (4) Focuses on the skills needed for classroom teachers to effectively use computers as a tool to enhance the instructional process. Prepares student to use basic computer applications—word processing, database, spreadsheet, graphics during instruction; examines a variety of software packages for use in the classroom; uses advanced applications—scanning, telecommunications, CD ROM, presentation software, desktop publishing with students; and explores a wide range of options for using computers in the classroom. *Su; \$20.00*

EDUC 402 Community Health Education (3) Cross-listed as AHNR 402. Philosophy of community health education with emphasis on historical, conceptual, and legal precepts.

EDUC 410 General Methods for Secondary Education (4) Designed to give preservice teachers experience in theory and practice teaching students ages 12 through 21. Instructional strategies and design, classroom management, differentiated learning needs, and implementation are addressed in field and clinical practice. Students are exposed to peers specializing in different content areas and to extensive and continuous field work. *Sp; preq. admission to teacher education program and EDUC 310; coreq. EDUC 430/MATH 470; \$25.00*

EDUC 420 Interdisciplinary Teaching Methods 2: Science and Mathematics (7) Incorporation of the general knowledge base for teaching. Problem solving and inquiry are emphasized in science and mathematics. Content-specific and general methods, patterns of instruction, and diagnostic techniques are used in a laboratory context and practiced in field experiences. Inquiry and reflective activities focus planning and action on the moral and ethical intentions and consequences of classroom thinking and actions. *F W Sp; preq. admission to teacher education program and EDUC 310, MATH 110S, 140, and 141; to be taken concurrently with EDUC 421; \$25.00*

EDUC 421 - EDUC 461

EDUC 421 Interdisciplinary Teaching Methods 1: Literacy and Social Studies (7) Incorporation of the general knowledge base for teaching. Problem solving and inquiry are emphasized in literacy and social studies. Content-specific and general methods, patterns of instruction, and diagnostic techniques are used in a laboratory context and practiced in field experiences. Inquiry and reflective activities focus planning and action on the moral and ethical intentions and consequences of classroom thinking, actions, and conditions. *F W Sp*; *req. admission to teacher education program and EDUC 310; to be taken concurrently with EDUC 420*; \$25.00

EDUC 430 Methods of Teaching Mathematics in Secondary Schools (4) Cross-listed as MATH 470. Designed to acquaint students with the practices and problems involved in teaching secondary (grades 7-12) mathematics. Problem solving, inquiry based teaching, and the use of technology are emphasized. General teaching methods, patterns of instruction, and diagnostic techniques, as they apply to the secondary mathematics curriculum, are used in a laboratory context and practiced in field experiences. *Req. MATH 405, at least 56 credit hours of required mathematical content, admission to teacher education program; coreq. EDUC 410; 4 contact, 1 clinical, 6 field*; \$25.00

EDUC 431 Studio Methods for Elementary Education (6) Cross-listed as ARTS 401. The methodologies, techniques, and materials of art instruction for elementary students. The special needs of students in grades K-8 are addressed. The appropriate range of activities and media are explored to maximize art instruction and its integration into the larger educational process. *Req. ARTH 101, ARTS 101, 102, 103, and admission to teacher education program*; \$25.00

EDUC 432 Studio Methods for Secondary Education (6) Cross-listed as ARTS 402. The methodologies, techniques, and materials of art instruction for adolescents. The special needs of students in grades 9-12 are addressed. The appropriate range of activities and media are explored to maximize art instruction and its integration into the larger educational process. *Req. ARTH 101, ARTS 101, 102, 103, and admission to teacher education program*; \$25.00

EDUC 433 Methods of Teaching Science in the Secondary School (4) Cross-listed as NTSC 433. Use of a variety of instructional strategies, science curricula, evaluation techniques, and community resources are examined. Establishing and maintaining safety in the classroom, field, and storage areas are emphasized. The use and care for living organisms in an ethical and appropriate manner are experienced. Students participate in the planning and implementation of science experiences for students in the field and clinical setting. *Req. BIOL 151, CHEM 141, GEOL 111, PSCI 251, EDUC 310; coreq. EDUC 410; 2 lec. 1 lab/clinical 6 field*; \$40.00

EDUC 434 Methods of Teaching Language Arts in the Secondary Schools (4) Cross-listed as ENGL 434. Provides preservice teachers with essential experiences in theory and practice for teaching language arts students, ages 12 through 21. Instructional strategies and design, classroom management, differentiated learning needs, and implementation are addressed in field and clinical practice. *Sp; req. senior class standing and acceptance into the teacher education program; coreq. EDUC 410*; \$25.00

EDUC 450 Directed Teaching and Seminar (15) A cumulative experience of ten weeks in area schools which includes a weekly seminar, both topical and process-oriented. *F W Sp; req. admission to the teacher education program and admission to student teaching*; \$125.00

EDUC 451 Internship in Extended Health Care Management (6) Cross-listed as AHNHR 451 and BUHE 451. Provides 400 hours of a structured and supervised professional experience within an approved extended health care organization. Students complete assigned projects and/or managerial tasks under joint supervision of a health care facility administrator and a university faculty member. *Su 10-wk, F W Sp as needed; req. coursework completed and permission*; \$10.00

EDUC 461 Research Problems in Health and Recreational Education (3) Cross-listed as AHNHR 461. Exploration of research methodologies, issues, and problems peculiar to health professions.

EDUC 495 Special Topics (2-4) Cross-listed as AHNR 495. Provides students an opportunity to gain additional knowledge or experience in a specific area or field.

Paramedic

EMTP 101 First Aid and CPR (2) Includes the American Red Cross Standard or National Safety Council first aid course related to bleeding control, obstructed airway management, splinting and bandaging techniques, and other emergency care procedures. Also includes the American Red Cross or American Heart Association adult CPR course. American Red Cross or National Safety Council first aid certification and Red Cross or American Heart Association adult CPR certification are granted upon successful completion of course. *Su F W Sp; \$5.00*

EMTP 102 CPR (1) Techniques of cardiopulmonary resuscitation for adults, children, and infants. American Red Cross or American Heart Association CPR certification is granted upon successful completion of this course. *Su F W Sp; \$5.00*

EMTP 110 Emergency Victim Care (10) The Ohio Basic Emergency Medical Technician training course which provides the framework upon which all other skills and knowledge are developed. Principles of emergency care, CPR, vital signs, patient handling, endotracheal intubation, automatic defibrillation, and patient medication administration techniques are included. *Su F W Sp; preq. advisor approval*

EMTP 120 EMS Systems (3) Introduction to pre-hospital emergency medical systems, including EMS history, types of systems, medical control, dispatch, quality assurance, communications systems, and record keeping. *Offered on demand; preq. advisor approval*

EMTP 130 Major Incident Response (2) Provides the student with the theoretical and practical foundations necessary to manage multiple casualty situations in the prehospital environment. *Offered on demand; preq. advisor approval*

EMTP 210 Paramedic Skills 1 (5) Expansion of basic skills and knowledge gained in the EMTA-Basic course in the areas of shock and fluid therapy, anatomy and physiology, patient assessment, and respiratory emergencies. Advanced skills include IV therapy, endotracheal intubation, MAST, and automatic and manual defibrillation. Includes DOT Paramedic Program Division 1 (Prehospital Environment, Sections 1-4) and Division 2 (Preparatory, Sections 1-5) and the administration of subcutaneous epinephrine for allergic reactions. *F; preq. Ohio certified EMT-A; six months EMT-A experience*

EMTP 211 Paramedic Skills 1 Lab (1) Laboratory and clinical experience which correlate with EMTP 210 Paramedic Skills 1. *F; \$5.00*

EMTP 212 Paramedic Skills 1 Clinical (1) Hospital and field clinical experiences for EMTP 210. *F*

EMTP 215 Advanced EMT Defibrillation (4) Prehospital diagnosis and treatment of various forms of sudden cardiac death. Focuses on prehospital defibrillation. Includes cardiovascular anatomy and electrophysiology, cardiopulmonary resuscitation, assessment and management of cardiac arrest, including electrical defibrillation. Successful completion allows the Ohio certified Advanced EMT to perform defibrillation. *F; preq. Ohio certified EMT-A; six months EMT-A experience*

EMTP 220 Paramedic Skills 2 (3) Emphasizes gaining access to, rescuing, and transporting a patient. Recognition and control of certain hazards, such as explosive material, downed electrical wires, toxic gases, and radiation. Use of radio equipment, protocols, and procedures for the transfer of information to the supervising physician. Includes DOT Paramedic Program Division 1 (Prehospital Environment, Sections 5-6). *F; preq. EMTP 210 or equivalent concurrently; \$20.00*

EDUC 495 - EMTP 220

EMTP 230 - ENGL 098

EMTP 230 Paramedic Skills 3 (8) Intensive emergency coronary care emphasis. Topics include pathophysiology, symptomatology, and emergency treatment of coronary artery disease, MI, angina pectoris, congestive heart failure, and other cardiac emergencies. Introduction to the general groups of drugs and the classification of each. Therapeutic effects, indications, contraindications, correct dosage, and side effects of specific drugs used in cardiac emergencies. Includes DOT Paramedic Program Division 2 (Preparatory, Section 5), Division 4 (Medical, Sections 1 and 2), and the American Heart Association Advanced Cardiac Life Support Provider course. *W; req. EMTP 210, 211, 212, and 220 or equivalent*

EMTP 231 Paramedic Skills 3 Lab (1) Laboratory and clinical experiences which correlate with EMTP 230 Paramedic Skills 3. *W; \$5.00*

EMTP 232 Paramedic Skills 3 Clinical (1) Hospital and field clinical experiences for EMTP 230. *W*

EMTP 240 Paramedic Skills 4 (8) Builds advanced skills and knowledge in the areas of medical emergencies, trauma emergencies, obstetric/gynecologic emergencies, pediatrics, and neonatal transport. Emphasis placed on clinical and on-squad experience. Includes DOT Paramedic Program Division 3 (Trauma), Division 4 (Medical, Sections 3-11), Division 5 (OB/Gyn/Neonatal), and Division 6 (Behavioral). *Sp; Req. EMTP 230, 231, and 232 or equivalent*

EMTP 241 Paramedic Skills 4 Lab (1) Laboratory and clinical experiences which correlate with EMTP 240 Paramedic Skills 4. *Sp; \$5.00*

EMTP 242 Paramedic Skills 4 Clinical (1) Hospital and field clinical experiences for EMTP 240. *Sp*

EMTP 250 Advanced Emergency Procedures (3) Didactic and laboratory instruction in advanced emergency procedures, such as nasotracheal intubation, cricothyrotomy, intraosseous infusion, external cardiac pacing, and other procedures. *Offered on demand; req. advisor approval*

EMTP 260 EMS Field Studies (3) Course relates field clinical experience of student to theory. Utilizes case review, discussion, and lecture for integration of theory with practice. *Offered on demand; req. advisor approval*

EMTP 270 EMS Management (3) Course develops knowledge and skills relative to management of an emergency medical service. *Offered on demand; req. advisor approval*

EMTP 295 Special Topics in EMS (1-4) Individual or small group study, under the supervision of an instructor, of topics not otherwise available to students. *Offered by arrangement*

English

ENGL 095 Basic Writing 1: Mechanics (4) Provides intensive practice with the basics of written expression: grammar, punctuation, usage, spelling, and sentence structure. Emphasis on correct use of standard English. Also focuses on basic summary and paragraph writing. *Su F W Sp; req. placement*

ENGL 097 Reading Development 1 (4) Initial reading course in developmental education. Major focus is on comprehension and vocabulary improvement, adaptability of reading rate, and test-taking skills for standardized tests. Includes, but is not limited to, recognition of patterns of organization and text structure, metacomprehension, aids to reading textbooks, strategies for building vocabulary, and test taking. Recreational and journal reading are required. *Su F W Sp; req. placement*

ENGL 098 Reading Development 2 (4) Second level reading course in developmental education. Major focus is on increased comprehension and vocabulary growth in content area reading. Includes, but is not limited to, identification and use of three levels of comprehension; use of three-stage reading plans, which include pre-reading, reading, and post-reading strategies; identification and writing main ideas through summarizing textbook material; becoming metacomprehensive readers; building general and specialized vocabulary. Reading fiction and nonfiction is required. *Su F W Sp; req. placement*

ENGL 099 - ENGL 222

ENGL 099 Basic Writing 2: Paragraphs and Essays (4) Provides practice in the process of writing and revising paragraphs and short essays. Standard organizational patterns for paragraphs and essays are required with an emphasis on the correct use of standard English. *Su F W Sp; preq. placement*

ENGL 105 Information Access (1) Prepares students to identify and find information using appropriate information technology, including the internet and World Wide Web, to evaluate resources and to format a bibliography. *F W Sp*

SPECIAL NOTE: The university placement test is prerequisite to enrolling in ENGL 111S. Students completing developmental courses are required to pass not only the course itself; but also the course exit exam before enrolling in English 111S. Those students who enter Shawnee State University with an English subject ACT score of 22 or higher or the SAT equivalent will be permitted to register for ENGL 111S without taking any English placement test. ENGL 111S, 112S, and 115S must be taken in sequence, beginning with 111S. This composition sequence is a prerequisite for advanced coursework in English (including the civilization and literature series).

ENGL 111S Discourse and Composition¹ (4) An introduction to discourse in both public and academic settings. *Su F W Sp; preq. placement or the appropriate developmental course(s), which may include ENGL 095, 097, 098, 099, and 100; \$5.00*

ENGL 112S Composition and Research¹ (4) An introduction to the relationship between research and composition. *Su F W Sp; preq. ENGL 111S; \$5.00*

ENGL 115S Composition and Literature (4) An introduction to the relationship between literature and composition. *Su F W Sp; preq. ENGL 112S; \$5.00*

ENGL 120 Vocabulary Expansion (2) A non-developmental course intended primarily to enhance the vocabulary skills of students with a reasonable range of existing vocabulary. *F Sp*

ENGL 121 Technical Writing (3) A course which stresses clarity in technical communications with emphasis on the improvement of writing style and the mastery of exact organization. Types of writing include reports (formal and informal), proposals, resumes, and specifications. Because of the textbook and specific writing assignments, this course is not open to liberal arts students. *Su F W Sp; preq. sophomore standing in a technical program*

ENGL 200 Introduction to Literature (4) An analysis of selected literary works which aims to develop reading and interpretive skills and to familiarize students with the language of literary study. *F*

ENGL 203 Introduction to Drama (4) Modern dramatic forms are analyzed in an attempt to define the genre. *Offered on demand*

ENGL 210 Introduction to Fiction (4) A study of forms and techniques of the novel, novella, and short story. *Offered on demand*

ENGL 211 Survey of English Literature 1 (4) Survey of the development of English literary traditions from the Medieval Period through the eighteenth century. *F*

ENGL 212 Survey of English Literature 2 (4) Survey of the development of English literature beginning with the Romantics and moving into contemporary writers and works. *W*

ENGL 222 Business Writing (4) A study of writing skills essential to the business world with special emphasis on the practical application of those skills to "real world" writing tasks. *Offered on demand*

¹ In keeping with the general education program's commitment to computer literacy (see Catalog p. 56), several sections of this course use computers in the teaching of composition.

ENGL 225S - ENGL 312

- ENGL 225S Civilization and Literature 1 (4)** Cross-listed as HIST 225S. This course is an interdisciplinary introduction to the major thoughts important in the development of western civilization. *Su F W Sp*
- ENGL 226S Civilization and Literature 2 (4)** Cross-listed as HIST 226S. An interdisciplinary introduction to the major thoughts important in the development of American civilization. *Su F W Sp*
- ENGL 227S Civilization and Literature 3 (4)** Cross-listed as HIST 227S. An interdisciplinary introduction to the major thoughts of various non-western civilizations. *Su F W Sp*
- ENGL 232 Creative Writing (Poetry) (4)** An advanced poetry writing course. Students study modern poetry at the same time they are writing their own. They also offer criticism of work done by others in the class.
- ENGL 240 Screenwriting (4)** An introduction to the elements of screenwriting. Students develop a screen adaptation of a published fictional work as well as study important distinctions between visual and literary art forms. *Offered on demand*
- ENGL 245 Creative Writing (Fiction) (4)** An introduction to the elements of fiction writing. Students critique their own manuscripts as well as study selected works of published writers.
- ENGL 251 Survey of American Literature 1 (4)** Study of major works and major authors from the Colonial Period through American Romanticism.
- ENGL 252 Survey of American Literature 2 (4)** Study of major works and major authors from the Age of Realism to the twentieth century.
- ENGL 273 Modern American Poetry (4)** Study of themes and forms prevalent in modern American poetry. *Offered on demand*
- ENGL 275 American Film History (4)** Cross-listed as HIST 275. Chronological study of the influence of American history upon American film, and vice versa. Students become acquainted with the work and themes of some of America's significant film directors and major genres of American popular film. *F and on demand*
- ENGL 280 Introduction to American Studies 1 (4)** Interdisciplinary study of American culture. *Offered on demand*
- ENGL 281 Introduction to American Studies 2 (4)** Interdisciplinary study of American culture. *Offered on demand*
- ENGL 299 Topics in English (1-4)** Study of selected topics not otherwise available. *Offered on demand*
- ENGL 300 Children's Literature (4)** Readings in literature that appeals specifically to elementary students. *Sp*
- ENGL 301 Shakespeare 1 (4)** Intensive study of the tragedies and histories.
- ENGL 302 Shakespeare 2 (4)** Intensive study of the comedies and problem plays.
- ENGL 305 Advanced Expository Writing (4)** Explores the current conventions of expository writing. Students are encouraged to see writing as a way of creating knowledge and as a means of expressing this knowledge to different audiences. *W; req. ENGL 111S, 112S, and 115S*
- ENGL 311 Major English Authors (Before 1800) (4)** A variable content course which focuses on major authors for the purpose of carefully analyzing their works and detailing their development as writers.
- ENGL 312 Major English Authors (After 1800) (4)** A variable content course which focuses on major authors for the purpose of carefully analyzing their works and detailing their development as writers. *Offered on demand*

ENGL 315 - ENGL 380

- ENGL 315 Theory and Practice in Composition (4)** Study of varied methods and strategies for teaching composition with special attention to classroom application for teachers.
- ENGL 321 The English Novel (4)** A variable content course which examines the emergence and development of the English novel. *Offered on demand*
- ENGL 322 Modern English Drama (4)** Study of the developments in English theatre in the 20th century. *Offered on demand*
- ENGL 323 Adolescent Literature (4)** Cross-listed as EDUC 323. A survey and methods course designed to give secondary and middle school level preservice teachers experience in the range, quality, genres, and styles of literature suitable for use in classrooms. The course also offers experience in curriculum design, instructional deliveries, evaluation, and recordkeeping, as well as field-based practice with students in grades seven through twelve. \$25.00
- ENGL 332 Poetry Workshop (3)** An advanced poetry writing course with a major emphasis placed on critiquing the writing of the students in the class for the sake of successfully marketing their work.
- ENGL 340 Literature of the Americas (4)** A study of the literature of Hispanic America with emphasis on the most celebrated contemporary writers. *Sp; preq. ENGL 111S, 112S, and 115S*
- ENGL 341 Literature of Initiation and Experience (4)** Study of literary works which detail growth and development of character. *Offered on demand.*
- ENGL 342 Women in Literature (4)** Study of works by and about women.
- ENGL 343 Black Authors (4)** Study of works about the Black experience. *Offered on demand*
- ENGL 344 Literature of Appalachia (4)** Exploration of southern Appalachian experience in literature. Includes works by authors past and present who are themselves products of the region or who have focused on the region in their prose or poetry.
- ENGL 346 River Literature (4)** Study of literary works in which rivers are central factors influencing experience. *Offered on demand*
- ENGL 349 Regional American Literature (4)** A variable content course of literary works which are distinct to a region and which provide a social perspective unique to a particular time and place. *Offered on demand*
- ENGL 351 Major American Authors (4)** Intensive study of one or two major authors to provide a detailed understanding of works, thought, and literary development.
- ENGL 360 Introduction to Language and Linguistics (4)** Cross-listed as LING 360. A discussion and analysis of the fundamental properties and processes of the world's languages. A review of the major systems and features which constitute language. A discussion of language change, typology, and aspects of language acquisition.
- ENGL 362 Patterns of English (4)** Cross-listed as LING 362. An examination of various English phonological and spelling patterns, followed by questions of variation and usage. Aspects of English phrase, clause, and sentence structure are also examined. *Preq. ENGL/LING 360*
- ENGL 365 History of English (4)** Cross-listed as LING 365 and HIST 365. A survey of the patterns and events which have shaped the English language from the time of the Anglo-Saxon to the present. *F; preq. ENGL/LING 360; This course does not fulfill any history course requirements of the history major.*
- ENGL 371 The American Novel (4)** A variable content course which examines the emergence and development of the American novel. *Offered on demand*
- ENGL 380 Fundamentals of Rhetoric (4)** Study of both ancient and modern theories of rhetoric. *Offered on demand.*

ENGL 381 - ENGL 490S

- ENGL 381 Fundamentals of Criticism (4)** Study of both ancient and modern theories of criticism. *Offered on demand*
- ENGL 383 The English Teacher and Society (4)** Analysis of the role of the English teacher in modern society, of the philosophies which underlie various methods of English teaching, and of the rationales for choosing various texts and methods. *Offered on demand*
- ENGL 399 Topics in Literature (1-4)** Study of topics not otherwise available. *Offered on demand*
- ENGL 411 16th Century Renaissance Literature (4)** Study of the major works of selected authors such as More, Sidney, Spenser, Marlowe, Shakespeare, Shelton, Wyatt, Surrey, and others. *Offered on demand*
- ENGL 421 17th Century Poetry and Prose (4)** Study of the major works of selected authors such as Bacon, Carew, Cowley, Donne, Herrick, Jonson, Marvell, Webster, and Milton.
- ENGL 424 The 18th Century Novel (4)** A consideration of major works and authors of the period. *Offered on demand*
- ENGL 434 Methods of Teaching Language Arts in the Secondary Schools (4)** Cross-listed as EDUC 434. Provides preservice teachers with essential experiences in theory and practice for teaching language arts students, ages 12 through 21. Instructional strategies and design, classroom management, differentiated learning needs, and implementation are addressed in field and clinical practice. *Sp; preq. senior class standing and acceptance into the teacher education program; coreq. EDUC 410; \$25.00*
- ENGL 441 The Romantics (4)** Study of the poetry and prose of major Romantic writers, including Blake, Wordsworth, Coleridge, Shelley, Byron, and Keats. *Offered on demand*
- ENGL 446 The Victorians (4)** Study of English poetry and prose from 1830 to 1900. *Offered on demand*
- ENGL 449 Native American Literature (4)** Study of works written by Native American writers.
- ENGL 455 English Language in Society (4)** Cross-listed as LING 455. Language variation by individual speakers is analyzed in relation to the reasons and extent of variation, paying particular attention to English. Then the processes and characteristics associated with different contact and social varieties of English are detailed. Finally, English geographic variation and patterning is reviewed. *Preq. ENGL/LING 360*
- ENGL 460 Topics in Linguistics (4)** Senior seminar in selected topics in linguistics: linguistics and literature, social aspects of language, psychological aspects of language, varieties of English, English as a second language, and Black English (including Pidgin and Creole). Can be taken more than once when different themes are offered. *Offered on demand; preq. ENGL 360*
- ENGL 461 19th Century American Literature (4)** Intensive study of major authors and works of the 19th century. *Offered on demand*
- ENGL 471 20th Century American Literature (4)** Intensive study of major authors and works of the 20th Century. *Offered on demand*
- ENGL 485 Senior Experience for Secondary Language Arts Majors (4)** Students examine in detail a selected topic of the instructor's specialty. A major research essay and oral presentation are required. Part of the course involves a portfolio review of previous writings in other courses. *F; preq. completion of 60 quarter hours in the major*
- ENGL 490S Senior Seminar (4)** Provides an opportunity for students to place their chosen field of study in an interdisciplinary context with intellectual, ethical, and historical perspectives. The seminar focuses on the synthesis and integration of various concepts by applying them to the analysis and solution of problems chosen in the context of their academic disciplines. Oral and written presentations of the seminar paper are required. *Su F W Sp; preq. senior standing and 44 general education program hours*

ENGL 495 Independent Study (4) Independent investigation of literary topics under the direction of a faculty member. *Offered on demand*

ENGL 499 Topics in Literature (1-4) A seminar course in selected topics in literature. Specific topic chosen by the instructor. *Offered on demand*

English as a Second Language

ESL 91 Elementary English 1 (4) Development of elementary listening, comprehension, speaking, reading, and writing skills in English. Laboratory exercises are used to reinforce these skills. *Offered on demand*

ESL 92 Elementary English 2 (4) Continuation of ESL 91. *Offered on demand;*
req. ESL 91

ESL 93 Elementary English 3 (4) Continuation of ESL 92. *Offered on demand;*
req. ESL 92

ESL 94 Intermediate English 1 (4) Development of intermediate oral communication skills in English, but with increased emphasis in reading and writing. May be taken concurrently with ESL 93. *Offered on demand; req. ESL 93 or satisfactory score on ESL assessment test*

ESL 95 Intermediate English 2 (4) Continuation of ESL 94. *Offered on demand;*
req. ESL 94 or satisfactory score on ESL assessment test

ESL 96 Intermediate English 3 (4) Development of advanced communicative skills in English. May be taken concurrently with ESL 97, 98, and 99. *Offered on demand; req. ESL 95 or satisfactory score on ESL assessment test*

ESL 97 Advanced English 1 (4) A follow-up to ESL 96. A course emphasizing oral proficiency and applied grammatical concepts. Improvement of speed and comprehension in reading through conscious analysis of paragraph structure and recognizing the progressive development of ideas. May be taken concurrently with ESL 96, 98, and 99. *Offered on demand; req. ESL 96 or satisfactory score on ESL assessment test*

ESL 98 Advanced English 2 (4) Training in the fundamental skills, including grammar, usage, organization, and development. For international students, includes idiomatic expressions and problems common to non-native speakers of English. Utilizes methodologies appropriate for international students. Designed to prepare international students for Discourse and Composition. *Offered on demand; req. ESL 96 or satisfactory score on ESL assessment test*

ESL 101 English for International Students (Equivalent to ENGL 111S) (4) Review of sentence structure, mechanics and usage, paragraph development, and short essay organization. For international students, includes reading and analysis of prose models and work on other English fundamentals. Emphasis on revising for clarity, coherence, and organization. Utilizes methods appropriate for ESL students. *Offered on demand*

Computer Aided Drafting and Design

ETCA 101 Introduction to CADD (3) Hands on experience using industrial standard hardware and software for computer aided drafting. Students learn to set up, edit, and output drawings using the latest in CADD technology. Introduction to file management techniques and the disk operating system (DOS). All classes focus on the use of AutoCAD,® unless otherwise stated. *F W Sp; coreq. ETEG 110 or CADD faculty approval; 2 lec. 3 lab; \$25.00*

ETCA 102 Mechanical Drafting with CADD (3) Students further develop and refine skills in operating a CADD workstation. Additional commands and more advanced techniques are introduced involving typical 2-D mechanical drafting and design techniques. *W; req. ETCA 101 or advisor approval; 2 lec. 3 lab; \$25.00*

ENGL 495 - ETCA 102

ETCA 103 - ETCA 299

- ETCA 103 CADD Menu Customization (3)** Students develop symbol libraries and icons to be used with student developed tablet and screen menus. *W; req. ETCA 101 or CADD faculty approval; 2 lec. 3 lab; \$25.00*
- ETCA 104 Advanced Drafting with CADD (3)** Advanced drafting and CADD concepts to include surface design and development and advanced descriptive geometry techniques. *Sp; req. ETCA 102 or CADD faculty approval; 2 lec. 3 lab; \$25.00*
- ETCA 105 3-D Modeling with CADD (3)** Wireframe modeling, surface modeling, and solid modeling are taught with an emphasis on mechanical parts design. Students gain an appreciation for the capabilities and limitations of each modeling technique. *Sp; req. ETCA 101 or CADD faculty approval; 2 lec. 3 lab; \$25.00*
- ETCA 120 Introduction to CADKEY® (3)** Introduction to 3-D modeling concepts using alternate CADD package(s) to help the student progress into the design of plastics mold cavities. *W Sp; req. or coreq. ETEG 110; 2 lec. 3 lab; \$40.00*
- ETCA 150 Computer Aided Machining (3)** Introduction to computer aided machining (CAM) and computer numerical control (CNC). Intended for students having no prior CAM or CNC experience. The course focuses on the creation and editing of tool path geometry, display control, file manipulation, verification of data, and output of CNC code. Laboratory experiences include CAM, CNC programming, and CNC machine tool operations. *Req. ETCA 101 or CADD faculty approval; \$30.00*
- ETCA 201 Small Building Design with CADD (3)** Introduction to architectural drafting through the design of a residential structure. Students create the drawings necessary to complete a typical set of house plans. Topics include, but are not limited to, design techniques, floor plans, foundation plans, elevations, wall sections, window and door schedules. *Sp; req. ETCA 103; 2 lec. 3 lab; \$25.00*
- ETCA 202 Piping Drawings with CADD (3)** Representation of piping in single and double line diagrams, isometric and orthographic diagrams. Design of pipe flanges given the size of pipe and the operating pressure. Template layouts for cutting pipe to form turns of various angles. *F; req. ETCA 103; 2 lec. 3 lab; \$25.00*
- ETCA 203 Welded Parts Design with CADD (3)** Welding processes and procedures are covered to the extent necessary to make production weldment drawings. Delineating weld symbols is emphasized. *F W; req. ETCA 103; 2 lec. 3 lab; \$25.00*
- ETCA 204 Casting and Mold Design with CADD (3)** Completion of a set of plans giving the specifications a foundry would need to manufacture a part. The plans include: a pattern drawing with gates, a core box drawing, the casting drawing of the part, and machined part drawing. *W Sp; req. ETCA 103; 2 lec. 3 lab; \$25.00*
- ETCA 205 LISP Programming (3)** A wide range of design problems are solved using LISP programming, subsequent to a thorough study of LISP functions, variable naming conventions, entity access, and device access. A variety of existing LISP routines and student written routines are analyzed. *F; req. ETCA 103 or CADD faculty approval; 2 lec. 3 lab; \$25.00*
- ETCA 220 MicroStation (3)** An introductory course on the methods and techniques of MicroStation (a high-end CAD package). Students develop skills in both 2-D drafting and 3-D design. *W; req. ETCA 101 or CADD faculty approval; \$25.00*
- ETCA 230 Rendering and Animation (3)** Advanced techniques in rendering and animating 3-D CAD models for presentation graphics. Animated "fly-bys" and "walk-throughs" allow the operator to view the CAD model as though walking through it or flying past it. Rendering techniques include the use of AutoDesk's 3-D Studio. *Sp; req. ETCA 105 or CADD faculty approval; \$25.00*
- ETCA 250 Solid Modeling (3)** In-depth instruction in solid modeling using constructive solid geometry and Boolean operations. Students create solid models and calculate mass properties to solve mechanical design problems. *Sp; req. ETCA 105; \$25.00*
- ETCA 299 Special Topics in CADD (1-5)** Offered as an elective for CADD students. Covers topics of special interest. *Req. instructor permission*

Engineering Technology Core

ETCO 110 Computer Software and DOS (2) Computer hardware and software concepts and fundamentals, including operating systems (DOS), the use of Windows and integrated applications software for word processing, spreadsheeting, and data bases. *F W Sp*; \$25.00

ETCO 115 Computer Programming for Technology (3) Utilization of computer hardware, a high level programming language, algorithms, and flowcharting to develop modular and structured programs for engineering technology applications. The emphasis of the laboratory work is to develop, debug, execute, and document Q BASIC language programs. Some knowledge of algebra is necessary. *F W Sp*; *coreq.* ETCO 110; 2 *lec.* 3 *lab*; \$25.00

ETCO 202 Statics and Strength of Materials (4) A study of the principles of torque and displacement in a wide variety of gearing applications along with the analysis of forces or loads acting upon the system. Analysis of stress and strain, strength of materials, friction, torsion, and moment of inertia. *Sp*; *preq.* MATH 132 or *faculty approval*; 3 *lec.* 3 *lab*; \$25.00

ETCO 210 Occupational Safety and Health Management (3) Industrial safety, occupational health issues, accident prevention, working conditions, provisions and policies of OSHA. Compliance with OSHA regulations. Course includes OSHA 10-Hour General Industry Voluntary Compliance Card. *F Sp*; *preq.* *sophomore standing and GPA of 2.0 or faculty approval*

ETCO 220 Hydraulics and Pneumatics (3) A study of the functions of various hydraulic and pneumatic components and methods of combining them to build complex systems. Emphasis on understanding the physical properties of fluids and gases and their use for power transmission and for control. *W Sp*; *preq.* MATH 130 or *faculty approval*; 2 *lec.* 3 *lab*; \$25.00

ETCO 225 Industrial Management (3) Understanding the attributes and skills necessary to be an effective team builder, communicator, supervisor, or manager. Prepares the student for leadership positions in industrial and high technology organizations. *W*; *preq.* *sophomore standing and GPA of 2.0 or faculty approval*

ETCO 230 Introduction to Robotics (3) Introduction to applications in industry. Emphasis on types, classifications, types of motion, economic impact, and safety. *Sp*; *coreq.* ETCO 220 and ETEM 110; 3 *lec.* 2 *lab*; \$30.00

ETCO 490S Senior Seminar (4) Provides an opportunity for students to place their chosen field of study in an interdisciplinary context with intellectual, ethical, and historical perspectives. The seminar focuses on the synthesis and integration of various concepts by applying them to the analysis and solution of problems chosen in the context of their academic disciplines. Oral and written presentations of the seminar paper are required. *Su F W Sp*; *preq.* *senior standing and 44 general education program hours*

Computer Engineering Technology

ETEC 102 Structured Programming with C (3) An introduction to the software development process through a modern block-structured language. Computer problem solving and program debugging strategies, data abstraction, modularity, parameter passing, and elementary data structures. *W*; *preq.* ETCO 110 and 115; 2 *lec.* 3 *lab*; \$25.00

ETEC 103 Data Structures with C (3) Fundamentals of computer data structures. Linked lists, stacks, and queues. Recursion and recursively-defined data structures. Tree structures. Advanced methods for searching and sorting, including hashing techniques. Introduction to complexity analysis. *Sp*; *preq.* ETEC 102; 2 *lec.* 3 *lab*; \$25.00

ETEC 199 Special Topics (1-14) Individual or small group study, under the supervision of an instructor, of topics otherwise not available to students. *Preq. advisor approval*

ETEC 211 - ETEC 351

- ETEC 211 Assembly Language Programming 1 (3)** Machine representation of numeric and non-numeric data, basic CPU architecture, instruction sets, addressing methods, arithmetic operations with integer and floating point data, subroutines, and basic input and output techniques. *F; preq. ETCO 115; 2 lec. 3 lab; \$25.00*
- ETEC 212 Assembly Language Programming 2 (3)** Continuation of ETEC 211. Advanced input and output techniques, techniques for interrupt handling, subroutine linkage of separately assembled modules, and drivers for custom built interfaces. *W; preq. ETEC 211; 2 lec. 3 lab; \$25.00*
- ETEC 241 Microprocessor Circuits 1 (3)** The study of small microprocessor based systems. Simple busses, timing, memory systems, and decoding. Techniques for interfacing MSI, LSI, and VLSI chips to system busses. Lab emphasis on expanding and interfacing to a microprocessor based system. *W; preq. ETEC 211; 2 lec. 3 lab; \$10.00*
- ETEC 242 Microprocessor Circuits 2 (3)** Continuation of ETEC 241. PLD, EPROM, and EEPROM uses and programming. Basic I/O techniques, signal conditioning and interfacing to the physical world. Lab emphasis on interfacing transducers such as temperature sensors and motors to a microprocessor based system. *Sp; preq. ETEC 241; 2 lec. 3 lab; \$10.00*
- ETEC 250 Computer System Integration with Novell (3)** Hardware and software integration techniques for stand alone and networked computer systems. Lecture covers motherboards, floppy drives, hard drives, video boards, network adaptor cards, cabling and network system software. Lab emphasis on assembling and integrating a networked computer system. *Sp; preq. ETCO 110 and 115; 2 lec. 3 lab*
- ETEC 275 Systems Programming (3)** A study of computer systems software and its role in modern computing systems. Operational and design details of assemblers, compilers, and linking loaders. Command language programming in modern operating systems. User interface design. *Sp; preq. ETEC 212; 2 lec. 3 lab; \$25.00*
- ETEC 280 Applications Programming with C (3)** Application design techniques, graphical user interfaces, object module libraries and linking, software testing. Lab emphasis on designing and building a complete GUI based software application. *F; preq. ETEC 103; 2 lec. 3 lab; \$25.00*
- ETEC 287 Applications Programming with VBASIC (3)** Application design techniques, graphical user interfaces, object module libraries and linking, software testing. Lab emphasis on designing and building a complete GUI based software application. *W; preq. ETEC 280 or faculty approval; 2 lec. 3 lab*
- ETEC 291 Intermediate Design Lab (3)** Provides the time and opportunity for students to work on the design and development of a computer engineering technology application. Enables the student to demonstrate competency in computer engineering technology under the guidance of a faculty mentor. *Sp; preq. sophomore standing; 1 lec. 6 lab*
- ETEC 299 Special Topics (1-14)** Individual or small group study, under the supervision of an instructor, of topics otherwise not available to students. *Preq. advisor approval*
- ETEC 315 Computer Architecture (3)** Focus on advanced microprocessor architectures. Lecture topics include internal microprocessor architectures, advanced busses, system components, system interconnect and comparative microprocessor evaluation. Lab emphasis on building advanced microprocessor based systems. *W; preq. ETEC 242; 2 lec. 3 lab; \$10.00*
- ETEC 320 Embedded Systems (3)** The use of microprocessor and microcontroller based subsystems as control components of a larger system or product. Lab emphasis on building and programming an embedded system. *Sp; preq. ETEC 315; 2 lec. 3 lab*
- ETEC 351 Networking and Communications 1 (3)** Interfaces from a computer system to external devices which support asynchronous and synchronous communications, flow-control paths, data transfer, packets, and physical interfaces. *F; preq. ETEC 241 and 280; 2 lec. 3 lab*

ETEC 352 - ETEC 477

ETEC 352 Networking and Communications 2 (3) A study of the ISO model protocols, logical connections and services, streams and datagrams, LANs, internetworking, routing, and servers. *W*; *preq.* ETEC 351; 2 lec. 3 lab

ETEC 361 Advanced Circuit Analysis 1 (3) Application of calculus to the modeling of systems. Mathematical approach to initial conditions. Introduction to (and application of) integral-differential equations to modeling of circuits and systems. Frequency domain analysis and Laplace transforms are introduced as an analysis tool. Application of PSPICE, BASIC, and/or 'C' computer programming to modeling of different systems. *F*; *preq.* ETEM 112 and MATH 202; 2 lec. 3 lab; \$25.00

ETEC 362 Advanced Circuit Analysis 2 (3) Application of Laplace transforms to system differential equations in the time and frequency domains with sinusoidal and complete harmonic signals. Topics include transfer functions, frequency response, and BODE plots, transients in DC/AC networks, initial conditions, superposition, the Initial and Final Value Theorems and the Shifting Theorem. A laboratory component is directed at demonstrating the transient effects of both AC and DC stimulus. *W*; *preq.* ETEC 361; 2 lec. 3 lab; \$25.00

ETEC 371 Realtime Operating Systems 1 (3) The study of realtime multiprocessing operating systems, processes and process states, concurrent programming, low level interprocess communications and synchronization, operating system service calls, and hardware interrupts. Lab emphasis on programming multiple process software applications using a realtime operating system. *F*; *preq.* ETEC 275; 2 lec. 3 lab; \$25.00

ETEC 372 Realtime Operating Systems 2 (3) Continuation of ETEC 371. High level interprocess communication, synchronization, and advanced operating system service calls. Detailed kernel analysis and modification. Lab emphasis on modifying and expanding a realtime operating system kernel and advanced methods of programming multiple process software applications using a realtime operating system. *W*; *preq.* ETEC 371; 2 lec. 3 lab; \$25.00

ETEC 373 Advanced Operating Systems with UNIX (3) A study of advanced operating systems using UNIX. File systems, processes and process development, remote access using FTP and Telnet and overall system management. *Sp*; *preq.* ETEC 103; 2 lec. 3 lab; \$25.00

ETEC 399 Special Topics (1-14) Individual or small group study, under the supervision of an instructor, of topics otherwise not available to students. *Preq. advisor approval*

ETEC 421 Digital Control Systems 1 (3) A study of the methods used to implement control theory concepts on digital machines. Analog vs. digital machines, open and closed loop systems, block diagrams, PID control algorithms. Lab emphasis on controlling physical devices using computer based control algorithms. *F*; *preq.* ETEC 320 and 362; 2 lec. 3 lab

ETEC 422 Digital Control Systems 2 (3) A study of the methods used to implement control theory concepts on digital machines extending the competencies gained from ETEC 421. Includes analog vs. digital machines, open and closed loop systems, block diagrams, and PID control algorithms. Lab emphasis is on controlling physical devices using computer based control algorithms. *W*; *preq.* ETEC 421; 2 lec. 3 lab

ETEC 430 Database Systems (3) A study of database management systems including the design, implementation, and maintenance of databases, applications, and programming techniques. Including the logical and physical representations of hierarchical, simple, and complex data and file relationships and their application in the major data models with a focus on the relational model. *F*; *preq.* ETEC 371 or *advisor approval*; 2 lec. 3 lab; \$25.00

ETEC 477 Concurrency (3) Principles of concurrent programming. Synchronization and interference. Data parallel algorithms and barriers. The mutual exclusion problem. Semaphores, monitors, and conditional critical regions. Synchronous and asynchronous message passing. Remote procedure call and rendezvous. Exploration of popular process interaction paradigms. *Sp*; *preq.* ETEC 372; 2 lec. 3 lab; \$25.00

ETEC 480 - ETEG 299

ETEC 480 Compiler Design and Implementation (3) Application of finite state automata as regular expressions to programming language design and analysis of the use of context-free grammars as a formal device for language syntax. Techniques of lexical analysis and parsing (top-down and bottom-up), symbol table management, code generation, and error handling. *W; req. ETEC 275 and 280; 2 lec. 3 lab; \$25.00*

ETEC 483 Software Engineering (3) An introduction to models and issues concerned with the development of high quality software including the life-cycle models, requirements analysis, specification and design techniques, implementation, documentation, configuration management, reliability, verification and validation, and maintenance. *F; req. ETEC 280; 2 lec. 3 lab; \$25.00*

ETEC 491 Design Laboratory 1 (4) A capstone experience in computer engineering technology involving the application of hardware and software components. The student demonstrates computer engineering technology competence by using the deductive method to apply computing concepts from the computer engineering program to an applications design project under the guidance of a faculty mentor. *W; req. senior standing; 1 lec. 9 lab; \$10.00*

ETEC 492 Design Laboratory 2 (4) Continuation of ETEC 491. *Sp; req. ETEC 491; 1 lec. 9 lab; \$10.00*

ETEC 495 Topics in Computing (1-5) A survey of contemporary developments in computer technology focusing on emerging hardware, software, and integrated systems. Discussions of new communications technology, architectures, processors, and applications guide the student in planning for future career decisions. *W; req. senior standing or advisor approval; 2 lec. 3 lab; \$25.00*

ETEC 499 Special Topics (1-14) Individual or small group study, under the supervision of an instructor, of topics otherwise not available to students. *Req. advisor approval*

Engineering Graphics

ETEG 105 Blueprint Reading (2) Fundamentals in reading and interpreting engineering drawings, blueprints, and schematics (pneumatic, hydraulic, electrical, and electronic). Using drawings to understand specification sheets, installation details, and to develop bills-of-material. Recognizing and understanding standard drawing symbols and terminology. *F W; 2 lec.; \$25.00*

ETEG 110 Engineering Drawing 1 (3) A basic course for students who have had little or no experience in engineering drawing. Develops fundamental principles through actual experience in both freehand sketching and scaled machine drawings. Includes orthographic, multiview drawings, geometric constructions, dimensioning practice, sectional views, and auxiliary views. *F W Sp; 2 lec. 3 lab; \$25.00*

ETEG 120 Engineering Drawing 2 (3) Application of basic principles to solve practical engineering problems. Surface design and development and applied descriptive geometry are used to determine the relationship between points, lines, and surfaces in spaces. *W; req. ETEG 110 or CADD advisor approval; 2 lec. 3 lab; \$25.00*

ETEG 130 Engineering Drawing 3 (3) Advanced drafting course. Includes detail and assembly drawings, parts lists, thread details and specifications, gear details, classes of fit and tolerances, and geometric dimensioning and tolerancing. *Sp; req. ETEG 120 or CADD advisor approval; 2 lec. 3 lab; \$25.00*

ETEG 299 Special Topics in Engineering Drawing (1-5) Offered as an elective for engineering drawing students. Covers topics of special interest. *Req. instructor permission*

Electromechanical Engineering Technology

ETEM 101 - ETEM 209

- ETEM 101 Electro Concepts (4)** A course in the concepts of electricity and electronics. Introduction to concepts of Ohm's Law, resistance, capacitance, inductance, power, and energy. Study of reactance, impedance, phasors, and power factors. DC and AC rotating machines are surveyed. Elementary solid state electronics. This course is not for electromechanical or computer engineering technology majors and is not applicable toward an associate degree. *Offered upon sufficient demand.*
- ETEM 110 Introduction to Electricity/Electronics (4)** Fundamental principles of DC and AC electricity. An introduction to motors, generators, relays, and transformers. An introduction to electronics with emphasis on process control applications, including PLCs. Not for electromechanical or computer engineering technology majors. *F W; preq. MATH 130 or equivalent or EM faculty approval; 3 lec. 3 lab*
- ETEM 111 Electrical Fundamentals 1 (DC) (4)** An introductory course in the study of electricity. Basic definitions of energy and electricity are introduced which lead to studies of resistance, Ohm's Law, series and parallel circuits, magnetism, simple meters, inductance, and capacitance. Direct current effects only. *F; coreq. MATH 130 or equivalent or EM faculty approval; 3 lec. 3 lab; \$30.00*
- ETEM 112 Electrical Fundamentals 2 (AC) (4)** Simple inductance-resistance and capacitance-resistance transient circuits; studies of alternating current fundamentals, phasor algebra, AC circuit analysis, power factor, and resonance. *W; preq. ETEM 111 or EM faculty approval; 3 lec. 3 lab; \$30.00*
- ETEM 115 Electromechanical Devices (4)** An introduction to devices where both electrical and mechanical principles are utilized. Includes DC motors and generators, 3-phase circuits, transformers, induction motors, alternators, and synchronous motors. *W; coreq. ETEM 112 or EM faculty approval; 2 lec. 3 lab; \$40.00*
- ETEM 121 Electronics 1 (3)** Introduction to discrete, bipolar solid state electronic devices and basic electronic circuits, including small signal amplifiers, transistor biasing, equivalent circuits, electronic unregulated DC power supplies, and special solid state devices. *Sp; coreq. ETEM 112 or EM faculty approval; 2 lec. 4 lab; \$25.00*
- ETEM 122 Electronics 2 (3)** Continuation of ETEM 121. Frequency response; decibels; cascaded, feedback, power, and field effect amplifiers; unijunction transistors; control circuits; four-layer devices; op amps; and regulated DC power supplies. *F; preq. ETEM 121 or EM faculty approval; 2 lec. 4 lab; \$25.00*
- ETEM 130 Electromechanical Drawing (2)** The study of mechanical drawing of both electrical and electronic circuits and components using electrical and electronic symbols. Includes power distribution, logic diagrams, printed circuits, schematics, and pictorial views. *Sp; preq. ETCA 101 and ETEG 101 or EM faculty approval; 1 lec. 3 lab*
- ETEM 201 Introduction to Electromechanical Systems (3)** An introduction to systems which use both electrical and mechanical principles. Thermal, hydraulic, pneumatic, vacuum, magnetic, and optic systems are utilized to stress the coordinated combination of previously learned concepts. *F; coreq. ETEM 122 or EM faculty approval; 2 lec. 3 lab; \$25.00*
- ETEM 208 Automation Fundamentals (3)** A study of electromechanical open and closed loop analog and digital systems. The microcomputer and programmable logic controller are used to interface a variety of input and output transducers to build complete automatic control systems. Emphasis on understanding interfacing feedback signals to process control. *W; preq. ETEM 115, 122, and 201; coreq. ETCO 220 and ETEM 211; 2 lec. 3 lab; \$40.00*
- ETEM 209 Robotics (3)** A survey course in Robotics which studies types of industrial robots, control schemes, and applications. *W; coreq. ETEM 208, ETEM 211, ETCO 220, or EM faculty approval; 2 lec. 3 lab; \$30.00*

ETEM 211 - ETEV 230

ETEM 211 Electronic Logic Circuits 1 (4) An introduction to solid state, integrated electronic logic. Practical applications of Boolean algebra, logic gates, binary pulse circuits, number systems, and computer arithmetic. *W; preq. ETEM 121 or EM faculty approval; 3 lec. 3 lab; \$25.00*

ETEM 212 Electronic Logic Circuits 2 (4) Continuation of ETEM 211. Integrated circuit applications which include combinational and sequential logic, printed circuits, counters, registers, decoders, signal converters, and an introduction to microcomputers. *Sp; preq. ETEM 211 or EM faculty approval; 3 lec. 3 lab; \$25.00*

ETEM 215 Electromechanical Design (3) Designed to provide the time and opportunity for students to work on the design, fabrication, assembly, and testing of electromechanical devices or systems. Promotes independent study, initiative, and creativity by requiring the student to develop the design with minimal staff supervision. *Sp; preq. ETEM 201 and 211; coreq. ETEM 212; 1 lec. 6 lab; \$25.00*

ETEM 220 Technical Presentations (2) Encompasses all of the principles which have been considered previously in the program. Electromechanical systems are analyzed and presented by the student. A thorough understanding of the applied principles is required. *Sp; preq. sophomore standing and electromechanical faculty approval; 1 lec. 3 lab*

ETEM 299 Special Topics in Electromechanical Engineering Technology (1-5) Individual or small group study, under the supervision of an instructor, of topics otherwise not available to students. *Preq. advisor approval*

Environmental Engineering Technology

ETEV 110 Introduction to Environmental Engineering and Regulations (3) An introduction and overview of the management of environmental restoration and pollution control projects. The development of an appreciation of the many aspects of project coordination. Problem discovery and definition, investigative techniques, work plans, health and safety plans, quality assurance/quality control plans, agency interfacing/permit acquisition, legal regulations, and reporting requirements are discussed. *F W; \$10.00*

ETEV 120 Laboratory Techniques (4) A specialized laboratory chemistry course for water/wastewater, air, and solid waste analysis. Course includes collection of samples, appropriate sampling protocols, and recordkeeping for such tests as heavy metals, F/M ratio, sludge age, fecal coliform, BOD, suspended solids, percent solids, ammonia, chlorine demand, and residual, pH, turbidity, etc. *F Sp; preq. CHEM 141; coreq. CHEM 142 and ETEV 110; 3 lec. 4 lab; \$40.00*

ETEV 130 Water Treatment Techniques (3) Designed to provide the necessary formal training to allow the student to attempt the State of Ohio Class I Water Operator exam. Emphasizes water sources/availability, water quality criteria, reasons for water treatment, distribution systems, theory of operations, and design applications. Basic water quality tests such as chlorine residual, fluoride, iron, manganese, and nitrate nitrogen are also covered. *F Sp; preq. CHEM 141; coreq. ETEV 120; 2 lec. 3 lab; \$25.00*

ETEV 210 Wastewater Treatment Techniques (3) Provides the necessary formal training to allow the student to attempt the State of Ohio Class I Wastewater Operator exam. Emphasizes types of treatment, theory of operation, design applications, basic operating tests such as BOD, DO, pH, F/M ratio, sludge age, detention timing, hygiene and public health aspects, sewer systems, and budgetary considerations. *F W; preq. CHEM 141 and ETEV 120; 2 lec. 3 lab; \$25.00*

ETEV 220 Hazardous Waste (3) An investigation of the state and federal programs for environmental assessments of regulating facilities for the disposal of hazardous wastes and the development of resource recovery programs. The creation, transportation, treatment methods, storage, and disposal of "hazardous wastes" are also studied. *F W; preq. CHEM 140 and ETEV 210; 2 lec. 3 lab; \$25.00*

ETEV 230 Solid Waste Reduction (3) A study of the long-term environmental impacts, methods of transporting, reduction, and storage of solid waste. *W Sp; preq. ETEV 220 and MATH 201; 3 lec. 3 lab; \$20.00*

ETEVE 240 - ETEVE 365

- ETEVE 240 Industrial Waste Treatment (3)** A study of industrial waste pretreatment requirements, equipment operation and design, testing, and removal systems. *W Sp*; *preq. CHEM 142 and ETEVE 220*; 2 *lec.* 3 *lab*; \$25.00
- ETEVE 250 Fluid Mechanics (3)** Fluid properties, fluid statics, including manometry, submerged surfaces, buoyancy, and stability of floating bodies. The principles of fluid flow, including Bernoulli's and energy equations, energy losses, and pump power. Analysis and design of pipe line systems, open channels, and pump selection. *F Sp*; *preq. ETCO 220, MATH 132, and PHYS 201 or ETCO 202*; \$25.00
- ETEVE 260 Automation for Environmental Technology (3)** Complete closed-loop control of analog process systems with PLC interfaces and computer control. Several loops are analyzed, such as flow, chemical feeds, temperature, and dissolved oxygen. *W Sp*; *preq. ETCO 220, ETEM 115, ETEVE 120, ETEVE 210, ETIN 111, MATH 132, and advisor permission*; 2 *lec.* 3 *lab*; \$30.00
- ETEVE 270 Toxicology (3)** A study of the health and safety issues of hazardous and infectious environments. Exposure limits, monitoring, symptoms, and prevention of the spread of common diseases through all forms of waste management are discussed. *F Sp*; *preq. CHEM 142 and ETEVE 220*; *coreq. BIOL 151*
- ETEVE 290 Summer Cooperative Education 1 (4)** First course of a two-course series designed to provide practical work experience on location at various waste treatment or hazmat facilities. The lecture portion is used to develop good work habits along with analytical thinking. *Preq. junior standing and advisor permission*
- ETEVE 310 Thermodynamics (3)** Energy analysis of engineering systems using the concepts and laws of thermodynamics. The principle of the mechanical equivalent of heat, behavior, or pure substances, use of thermodynamic property tables, and study of gas mixtures. Application of the Carnot cycle to both heat engines and reversed heat engines. *F W*; *preq. ETEVE 250, MATH 201, PHYS 203*
- ETEVE 315 Water Treatment 2 (3)** A continuation of ETEVE 130, designed to prepare students for advanced positions in municipal and industrial water treatment facilities. Course includes plant design, chemical feed rates, removal times, and process parameters. *F*; *preq. BIOL 151 and ETEVE 130*; *coreq. CHEM 200*; 2 *lec.* 3 *lab*; \$25.00
- ETEVE 325 Wastewater Treatment 2 (3)** A continuation of ETEVE 210, designed to prepare students for advanced positions in municipal and industrial wastewater treatment facilities. Course includes plant design, chemical feed rates, and process parameters. *W*; *preq. BIOL 151 and ETEVE 210*; *coreq. CHEM 200*; 2 *lec.* 3 *lab*; \$25.00
- ETEVE 335 Air Pollution 2 (3)** Second course of a two-part series in the air quality control field. Through industrial emissions modeling, emphasis is placed on environmental impact studies and emissions removal. *W*; *preq. GEOG 311 and MATH 201*; 2 *lec.* 3 *lab*; \$25.00
- ETEVE 345 Management of Hazardous Material (3)** This course focuses on recognizing a potentially hazardous condition. Topics covered include material handling, storage, and labeling; fire safety; confined space entry; prevention of accidents; safety program development; accident reporting; and regulation created under OSHA and waste management laws. Topical group and individual discussions may be included to supplement course materials. *F*; *preq. ETEVE 220*; 2 *lec.* 3 *lab*; \$25.00
- ETEVE 355 Hazardous Material Spill Response (3)** This course focuses on defining the nature and extent of emergency situations due to accidental spills. How best to confine and deal with the spill situation, including appropriate response actions, personal safety and protective equipment, and planning for evacuation are emphasized. *W*; *preq. ETEVE 345*; 2 *lec.* 3 *lab*; \$25.00
- ETEVE 365 Shipping and Handling of Hazardous Materials (3)** Proper transportation of hazardous and industrial wastes, following EPA and DOT regulations, is presented, including pre-trip and load inspections, labeling, placarding, manifesting, safe delivery of load, and emergency procedures. Proper methods of storage of hazardous wastes are discussed. State-of-the-art methods of disposal are explained, including secure landfill operations, deep well injection, incineration, and recycling of hazardous wastes. *W*; *preq. ETEVE 220*

EVEV 390 - EVEV 490

EVEV 390 Summer Cooperative Education 2 (4) Continuation of EVEV 290. This course provides additional training and practical work experience on location at various waste treatment or hazmat facilities, which are different from those used for EVEV 290. *Prq. EVEV 290 and advisor permission*

EVEV 410 Groundwater Hydrology (3) An overview of basic groundwater hydrology, groundwater flow systems, well design, and groundwater management. Emphasis is placed on the environmental aspects of groundwater development and management. *F; prq. CHEM 200 and GEOG 112; coreq. MATH 202 or 250; 2 lec. 3 lab*

EVEV 415 Infectious Waste/Communicable Diseases (3) Third course of a three-part series (EVEV 220, 270) with emphasis placed on reduction and treatment techniques and the formation, management, and control of residual wastes. Public health and safety issues, radiation theory/health physics and its effects on the human body, monitoring, and data evaluation are also studied. *F; prq. EVEV 240*

EVEV 420 Introduction to Geographic Information Systems (3) Introduction to the use of computer aided drafting techniques to document municipal, utility, and governmental information in a graphics format. *F; prq. ETCO 115 and GEOL 112; \$20.00*

EVEV 425 Solid Waste Disposal 2 (3) Study of the control and management of a solid waste reduction and storage facility. Emphasis on process flows, monitoring, and control. *Sp; prq. EVEV 230; coreq. MATH 202 or 250; 2 lec. 3 lab; \$20.00*

EVEV 430 Statistical Sampling and Control (3) A study of probability and statistical theory and the relationships of these concepts to applications in waste treatment sampling and quality control. *W; prq. EVEV 270 and MATH 202 or 250; 2 lec. 3 lab; \$25.00*

EVEV 435 Monitor and Control of Pollution Sources (3) A broad view of all major aspects of pollution control. Includes information about pollutant sources, effects and dispersion of pollution, legal authority for pollution control, measurement and control of emissions, enforcement of regulations, inspections, and implementation plans. Stresses the basic technique of industrial source sampling following EPA approved methods, principles involved in the design of control devices, and hands-on practical experience with field monitoring instrumentation. *F; prq. EVEV 245 and GEOG 311; 2 lec. 3 lab; \$25.00*

EVEV 440 Environmental Regulations 2 (3) A study of American political institutions and a brief history of the American environmental movement and the resulting environmental regulation. Emphasis is on NEPA, RCRA, CERCLA, EPCRA, CAA, CWA, SDWA, HMTA, TSCA, FIFRA, the Clean Water Act, the Clean Air Act, and the Asbestos Hazard Emergency Response Act. *W Sp; prq. EVEV 220; \$10.00*

EVEV 445 Hazardous Site Remediation (3) A projects course in which students are given a simulated waste site. The student prepares a site assessment, risk assessment, categorization, and permit requirement acquisition. A containment plan, treatment plan, sampling, monitoring, shipping, and storage plan are also developed. The course takes the student through a complete site remediation project. *Su Sp; prq. EVEV 335, 355, 365, 420, 430, 435, and advisor permission; coreq. EVEV 480; 2 lec. 3 lab; \$25.00*

EVEV 480 OSHA Industrial 40 HR (4) Designed to meet the requirements of SARA - 29 CFR Part 1910.120(e). Health and safety course for environmental personnel who may be involved in the investigation and remediation of hazardous waste sites. Topics include air monitoring instrumentation, air purifying respirators, SCBA, SARS, protective clothing, confined space entry, decontamination, and simulations of hazardous materials response incidents. Students develop the skills necessary to perform hazardous waste clean-up operations and to minimize risk to their safety and health through hands-on lab experiences. *Su F Sp; prq. EVEV 430; coreq. EVEV 440 or advisor approval; 3 lec. 3 lab; \$40.00*

Instrumentation Technology

- ETIN 103 Industrial Electricity (3)** Designed to familiarize the student with the National Electrical Code and practices used in industry to install electrical conductors, switching equipment, and overload protection and equipment. Course study includes motors, generators, and machine controls. *Sp; preq. ETEM 111 and 112; 2 lec. 3 lab; \$30.00*
- ETIN 111 Industrial Electronics (3)** Designed to familiarize the student with industrial electronic circuits, including amplifiers, DC power supplies, and integrated circuits. *Sp; preq. ETEM 111 and 112; 2 lec. 3 lab; \$30.00*
- ETIN 120 Process Instrumentation (4)** Introduction to measurement and control systems for temperature, pressure, and fluid flow. Dynamic response characteristics of instruments and calibration methods. Introduction to transducers, transmitters, controllers, and control systems. Both electrical and pneumatic systems are included. *Sp; 3 lec. 3 lab; \$30.00*
- ETIN 185 Instrumentation Internship (6)** Eleven weeks of supervised work experience in industry which relates directly to the student's field of study. Supervisory visits by the instructor are coordinated with periodic evaluations by the industry to critique the performance of the student. *40 lab*
- ETIN 201 Instrumentation Electronics (4)** Designed to familiarize the student with the electronic equipment and devices found in electronic instrumentation. High voltage power supplies, amplifiers, input and output transducers, recording devices, ultrasonics, synchros, telemetering, remote control, and optical electronics are included. *F; preq. ETIN 111; 2 lec. 5 lab; \$30.00*
- ETIN 202 Programmable Controllers 1 (4)** Introduction to basic industrial control circuits and schemes using the programmable controller as a control device. Instruction on the proper methods of programming the controller for the desired scheme. *F; preq. ETIN 111; 2 lec. 5 lab; \$30.00*
- ETIN 203 Programmable Controllers 2 (4)** A continuation of ETIN 202, including more advanced control using the controller as a programmable controller. Proper methods of interfacing the programmable controller to the controlled device and peripheral devices. *W; preq. ETIN 111; 2 lec. 5 lab; \$30.00*
- ETIN 221 Instrument Fundamentals (4)** Designed to provide the student with a knowledge of instruments. Introduction to the field, ship and industrial safety, care and use of hand and power tools, soldering techniques, reading and interpreting instrumentation drawings, measurement and control devices, final control elements, and standards and calibration. *F; preq. ETIN 120; 3 lec. 3 lab; \$30.00*
- ETIN 223 Measurement Principles (4)** Industrial methods of measuring pressure, temperature, and flow with various types of measuring devices. The theory of operation of manometers, thermometers, strain gauges, and other precision measuring equipment. *Sp; preq. ETIN 201 and 221; 3 lec. 3 lab; \$30.00*
- ETIN 224 Industrial Control (4)** Introduction to basic industrial control circuits and schemes. Pneumatic, hydraulic, electrical, and electronic control. *W; 3 lec. 3 lab; \$30.00*
- ETIN 225 Distributive Control Systems (4)** The procedures of using and configuring a distributive process control system. The student is required to implement the control system. *Sp; preq. ETIN 224; 3 lec. 3 lab; \$30.00*
- ETIN 251 Biomedical Instrumentation (4)** Study of cardiovascular instruments; pacemakers; defibrillators; and respiratory, ultrasound, and other life-supporting and life-saving instruments. *Offered upon sufficient demand; 3 lec. 2 lab; \$30.00*
- ETIN 252 Techniques and Devices for Electronic Troubleshooting (4)** Instructs the student in procedures for finding malfunctioning cards and components in electronic instruments. Test equipment is used to find the malfunctioning components. *Offered upon sufficient demand; preq. ETIN 210 and 251; 3 lec. 2 lab; \$30.00*

ETIN 103 - ETIN 252

ETIN 299 - ETPPL 230

ETIN 253 Internship 1 Work in Hospital (3) Students work in a hospital with biomedical personnel, under the direct supervision of the hospital. Offered upon sufficient demand; *preq.* ETIN 252; *coreq.* ETIN 251; 1 lec. 14 lab; \$30.00

ETIN 261 Instrumentation for Circulatory Systems (3) Study of instruments used in the circulatory system—acoustic, ultrasonic, electronic, and radiologic devices. Offered upon sufficient demand; *preq.* ETIN 252; 2 lec. 2 lab; \$30.00

ETIN 262 Bio Voltages (3) Study of the origin and usefulness of ECG, ERG, and EEG. Offered upon sufficient demand; *preq.* ETIN 251; 2 lec. 2 lab; \$30.00

ETIN 263 Internship 2 Work in Hospital (3) Continuation of ETIN 253. Safety testing, preventive maintenance, inspection, troubleshooting, and repair of biomedical equipment under the supervision of the hospital clinical engineer or department supervisor. Offered upon sufficient demand; *preq.* ETIN 253; 1 lec. 14 lab; \$30.00

ETIN 299 Special Topics in Instrumentation (1-5) Offered as an elective for instrumentation students. Covers topics of special interest. *Preq. instructor permission*

Machining

ETMA 140 Machine Tools (3) The basics of metal chip making technology. Topics include safety, measurements, bench work, drilling, tuning, shaping, planing, milling, and grinding. Properties and uses of ferrous and non-ferrous alloys, cutting fluids, welding, and foundry practices. Laboratory experiences include chip making processes and tooling methods. *W Sp*; 2 lec. 3 lab; \$40.00

Plastics Engineering Technology

ETPL 100 Plastics Manufacturing (3) An introductory overview of the different plastic resins, processing methods, and terminology. Lectures cover different types of plastic, identification tests, polymerization, molecular growth, and processing methods. Laboratory experiences in extrusion, injection, thermoforming, compression, and other molding and fabricating operations. *F*; 2 lec. 3 lab; \$40.00

ETPL 200 Injection Molding (4) Basic topics in the processing of thermoplastic resins. Hands-on operation of injection molding machines and introduction to principles of injection molding processing of thermoplastics. *Sp*; *preq.* ETPL 100 or plastics faculty approval; 3 lec. 3 lab; \$40.00

ETPL 205 Extrusion/Blow Molding (4) Continuation of ETPL 200. Basic topics in processing; study of the extrusion and blow molding processes of thermoplastic resins. *F*; *preq.* ETPL 200 or plastics faculty approval (plastics faculty approval waived for students in the one-year certificate program); 3 lec. 3 lab; \$40.00

ETPL 210 Thermoforming/Finishing (4) Continuation of ETPL 100 and ETPL 205. Basic topics in the thermoforming area and the study of industrial manufacturing methods not encountered in the previous courses. Includes printing, cementing, electroplating, metalizing, hot stamping, polishing, engraving, machining, and other decorating and finishing processes. *W*; *preq.* ETPL 205 or plastics faculty approval; 3 lec. 3 lab; \$40.00

ETPL 215 Thermosetting Processes (4) Study dealing with processing of thermoset materials. Hands-on operation of thermoset molding machines and introduction to principles of processing thermoset resins. *Sp*; *preq.* ETPL 210 or plastics faculty approval; 3 lec. 3 lab; \$40.00

ETPL 230 Properties of Polymeric Materials (4) Basic design considerations in use of polymeric materials. Because of applications-oriented approach, the reasons for using designs and polymers are presented. Extensive usage of tables on properties and shapes. *F*; *preq.* ETPL 100, CHEM 200, or plastics faculty approval; 3 lec. 3 lab; \$40.00

ETPL 240 - ETPL 430

ETPL 240 Testing of Plastics (3) Study of testing materials and the mechanical, thermal, electrical, optical, weathering, flammable, and environmental characteristics of plastic resins. ASTM experiments and written technical reports on the property changes of plastics under various conditions. Introduction of statistical quality control methods as related to material testing. *F; preq. ETPL 100, MATH 130, or plastics faculty approval; 2 lec. 3 lab; \$40.00*

ETPL 299 Topics in Plastics (1-5) Offered as an elective for plastics students. Covers topics of special interest. *Preq. instructor permission*

ETPL 300 Plastics in Society (2) Study of current trends in policy formation in the plastics industry, including problem solving processes and procedures. Topics include recycling, waste management, public policies, and landfills. *F; preq. ETPL 100; \$40.00*

ETPL 310 Plant Layout and Material Handling (3) Principles of plant layout and materials handling, including utilization of workers, materials, and machines for efficient application of all resources. CADD exercises as related to P.L. development. *W; preq. ETCA 120 or plastics faculty approval; 2 lec. 3 lab; \$40.00*

ETPL 320 Production Cost Analysis (3) Understanding the fundamentals of production cost accumulation systems, methods engineering, work measurement, and manufacturing cost control. *Sp; preq. ETPL 100, MATH 132 or equivalent, or plastics faculty approval; \$40.00*

ETPL 330 Material Science (3) Introduction to a broad field of materials, including metals, ceramics, and wood. Emphasis on their nature and behavior to provide a basis for comparison used in the development of new markets for polymers. *W; preq. ETPL 230 or plastics faculty approval; 2 lec. 3 lab; \$40.00*

ETPL 400 Statistical Process/Quality Control 1 (4) Study of probability and statistical theory and the relationships of these concepts to applications in a production environment through statistical process/quality control. *F; preq. MATH 132 or plastics faculty approval; 3 lec. 3 lab; \$40.00*

ETPL 405 Statistical Process/Quality Control 2 (4) Study of the methods used on SQC and SPC, including X bar and R charts (variables), p and np charts (attributes), interpretation of charts, Pareto analysis, Histograms and curve fitting, and Demming's fourteen points for quality. Lab sessions focus on computer analysis of statistical production data. *W; preq. ETPL 400 or plastics faculty approval; 3 lec. 3 lab; \$40.00*

ETPL 410 Applied Statistical Experimentation (4) Study of the methods used in formalized design of experiments. Develops ability to construct, conduct, and analyze a statistically sound experiment. Taguchi's, Plackett's, and Burman's methodologies are studied. Orthogonal arrays, variance, and experiment structure are explored through the use of two software packages designed specifically for D.O.E. *Sp; preq. ETPL 405 or plastics faculty approval; 3 lec. 3 lab; \$40.00*

ETPL 420 Plastics Part Design (3) Study of thermoplastic and thermoset part designs. Assigned projects develop an understanding of design parameters. Emphasis is placed on combining several areas of knowledge to design a plastic part. *F; preq. ETPL 230, 330, ETCA 120, or plastics faculty approval; 2 lec. 3 lab; \$40.00*

ETPL 425 Mold Design and Analysis 1 (4) Development of a mold using the part designed by the student in ETPL 420. Design and analysis of thermoplastic injection molds, extrusion dies, and blow molding using Moldflow Design and Analysis and Cadkey programs. Includes geometric dimensioning, cams, and other special techniques. May include hot runner systems. *W; preq. ETPL 420 or plastics faculty approval; 3 lec. 3 lab; \$40.00*

ETPL 430 Mold Design and Analysis 2 (4) Continuation of ETPL 425. Development of a mold using the part designed by the student in ETPL 420. Design and analysis of thermoplastic injection molds using Moldflow Design and Analysis programs. *Sp; preq. ETPL 425; 3 lec. 3 lab; \$40.00*

ETPL 440 - FREN 212

ETPL 440 Advanced Manufacturing Techniques (3) Develops the student's ability to recognize and distinguish the following production disciplines: MRP, MRP II, JIT, CIM, MPS, capacity planning, and scheduling. *F; preq. ETPL 215, 310, 320, or plastics faculty approval; \$40.00*

ETPL 450 Advanced Processing 1 (4) A detailed study of the various theories of processing and polymer rheology. Theoretical aspects of material transfer, melting mechanisms, and part formation. *W; preq. ETPL 215, 330, or plastics faculty approval; 3 lec. 3 lab; \$40.00*

ETPL 455 Advanced Processing 2 (4) Continuation of ETPL 450. Integration of previously acquired processing knowledge with the theoretical knowledge acquired in ETPL 450. *Sp; preq. ETPL 450 or plastics faculty approval; 3 lec. 3 lab*

ETPL 460 Composites (3) Provides a unified view of the composite industry. Topics include: raw materials, curing agents, fillers, various fiber reinforcements, and the various processing methods. *F; preq. ETPL 330 or plastics faculty approval; 2 lec. 3 lab; \$40.00*

ETPL 470 Senior Project (4) Provides knowledge necessary to construct a basic plastic mold developed in ETPL 420. Lab experience involves interpretation of tool prints, materials, and processing used in the actual construction of this plastic mold. *F; preq. ETPL 290, 420, 425, and 430 and senior standing; 2 lec. 6 lab; \$40.00*

ETPL 499 Special Topics in Plastics (1-5) Offered as an elective for plastics students. Covers topics of special interest. *Preq. instructor permission*

Robotics

ETRO 211 Robotic Interfacing (4) Study of hardware and software for interfacing programmable controllers, microprocessors, and computer control to a robotic arm with interaction of peripheral machines and equipment. *Offered upon sufficient demand; preq. ETEM 209 or ETCO 230; 3 lec. 3 lab; \$30.00*

ETRO 212 Robotic Applications (4) Advanced study and training in high technology robot operations and applications with emphasis on continuous and controlled path robots, programmable logic control systems, and production systems and operation. Extended practice in off-line programmable set-up, adjustment, and operation of robotic work cells and materials handling systems. *Offered upon sufficient demand; preq. ETRO 211; 3 lec. 3 lab; \$30.00*

ETRO 213 Robotic Maintenance & Servicing (4) Instruction in servicing and troubleshooting robotic and peripheral automated systems. Emphasis on mechanics, hydraulics, and associated electrical and electronics. *Offered upon sufficient demand; preq. ETRO 212; 3 lec. 3 lab; \$30.00*

French

FREN 111 Elementary French 1 (4) Beginning course of a three-quarter, first-year sequence. Basic grammatical concepts and patterns. Emphasis is on development of reading, listening, comprehension, speaking, and writing skills. *Su F W Sp; \$5.00*

FREN 112 Elementary French 2 (4) Continuation of FREN 111. *W Sp; preq. FREN 111; \$5.00*

FREN 113 Elementary French 3 (4) Continuation of FREN 112. *Sp; preq. FREN 112; \$5.00*

FREN 211 Intermediate French 1 (4) An intensive review of grammar and sentence structure and introduction to selected readings in French literature. Oral expression is stressed. *Offered on demand; preq. FREN 113; \$5.00*

FREN 212 Intermediate French 2 (4) Continued intensive review of grammar. Sight translation is stressed. Conversational drills include advanced idiomatic expressions. *Offered on demand; preq. FREN 211 or instructor approval; \$5.00*

FREN 213 Intermediate French 3 (4) Advanced vocabulary and sentence structure are stressed. Emphasis is on writing and free composition. *Offered on demand; preq. FREN 212 or instructor approval; \$5.00*

Geography

GEOG 125 World Geography (4) Concerns world's regions and nations, resource use, cultural groups, and political patterns. Designed to develop an understanding of world affairs and the applications of geography in general. *F Sp*

GEOG 130 Economic Geography (4) Systematic survey of locational economic patterns and their interrelationships. *F W*

GEOG 201 Cultural Geography (4) Impact of various cultures on landscape, distribution of cultural traits, ecological adaptations, and cultural areas throughout the world. *F Sp*

GEOG 225 Physical Geography (4) Systematic survey of earth-sun relationships, land forms, climate, soils, and natural vegetation. *Su W*

GEOG 230 Urban Geography (4) Study of city function, patterns, and past and current problems confronting the city, including planning, zoning, housing, and urban renewal. *Offered as demand indicates.*

GEOG 242 Geography of Ohio (4) Detailed regional study of physical background, settlement, and economic development. *Offered as demand indicates.*

GEOG 243 Geography of Appalachia (4) A study of Appalachia from a geographical approach, including a detailed examination of physical aspects (climate, soil, vegetation, minerals, and water resources), historical development both past and present, settlement patterns, and economic patterns of the region. *Offered as demand indicates.*

GEOG 299 Special Topics in Geography (1-4) Individual or small-group study, under the supervision of instructor, of topics not otherwise available to students. Separate courses, repeatable for credit. *Preq. GEOG 101, 125, 130, or 201*

GEOG 310 Medical Geography: Geography of Life or Death (4) Relationship between disease and the physical and socio-economic environ. Topics include disease ecology, historical patterns of cholera and plague, tropical disease, weather and health, cancer and heart disease in the U.S., hunger and the environment, distribution of resources, and introduction to facilities location planning. *Su alternate years, Sp*

GEOG 311 Air Pollution (4) Cross-listed as NTSC 311. Examination of air pollutants and their social and economic impacts, control strategies, and air pollution planning. *Su alternate years, W*

GEOG 350 Regional Geography: Geography of North America (4) The U.S. and Canada studied from a geographical perspective, including detailed examination of climate, soil, vegetation, minerals, water resources, historical development, settlement patterns, and economic aspects of the region. *W*

GEOG 351 Regional Geography of the Middle East (4) The Middle East — a cradle of civilization, birthplace of three world religions, crossroads, oil resource area, site of persistent conflict since WWII. The course addresses these aspects within the context of regional geography. *Sp*

GEOG 399 Special Topics in Geography (1-4) Individual or small-group study, under the supervision of instructor, of topics not otherwise available to students.

GEOG 404 Transportation Geography and Management (4) Examination of the geography of transport routeways and the geographic factors governing their evolution and use. Various modes (e.g. rail, water, highway) are discussed in terms of facilities, environmental impacts, rate structures, and commodities shipped. Decision processes of shippers, carriers, and government are examined. *F alternate years; preq. one course in GEOG or ECON*

FREN 213 - GEOG 404

GEOG 499 - GEOL 495

GEOG 499 Special Topics in Geography (1-4) Individual or small-group study, under supervision of instructor, of topics not otherwise available to students. Separate courses are repeatable for credit. *Preq.* GEOG 125, 130, or 201.

Geology

GEOL 111 Rocks, Minerals, and Fossils (4) Introduction to earth materials. Strong emphasis on laboratory identification of rocks, minerals, and fossils. Lecture topics include several key earth processes and important geologic theories. Course includes laboratory assignments and a field trip to fossil localities near Portsmouth. *F W*; 3 lec. 2 lab; \$5.00

GEOL 112 Environmental Geology (4) Analysis of complex interaction between Earth and man. Emphasis on natural hazards such as floods, earthquakes, volcanic eruptions; waste disposal; and groundwater, mineral, and energy resources. Course includes laboratory assignments and a field trip. *F Sp*; 3 lec. 2 lab; \$5.00

GEOL 201 Physical Geology (4) Introduction to earth materials and the processes that shape the Earth's surface. Emphasis on important earth processes such as volcanism, weathering, glaciation, and earthquakes; and theories which have modified our explanation of geologic phenomena. Course includes laboratory assignments and a field trip to Hocking Hills. *F*; 3 lec. 2 lab; \$5.00

GEOL 202 Historical Geology (4) The history of the Earth and its inhabitants. Emphasis on major physical and biological events that have profoundly affected the Earth, on causal mechanisms of geological events, and on the theories that have changed our interpretation of the Earth's history. Course includes lecture, lab, and field trip to localities in southern Ohio. *W*; *preq.* GEOL 201 or instructor permission; 3 lec. 2 lab; \$5.00

GEOL 290 Seminar in Geology (1-4) Discussion of advanced topics in geology.

GEOL 295 Independent Study (1-4) Independent geology investigation, under the direction of a faculty member.

GEOL 299 Special Topics in Geology (1-4) Individual or small-group study, under the supervision of instructor, of topics not otherwise available to students.

GEOL 301 Invertebrate Paleobiology (4) An introduction to major groups of invertebrates that are commonly preserved in rocks. Emphasis on preservation, morphology, collection, and geological and biological significance of invertebrate micro- and mega-fossils. *Preq.* GEOL 202 or instructor permission; 3 lec. 2 lab; \$5.00

GEOL 302 Mineralogy (4) Systematic study of minerals that constitute the Earth. Classification, occurrence, and identification of silicate/nonsilicate minerals. Course builds a foundation for the study of advanced Earth materials and processes. *Preq.* GEOL 111 or permission; 3 lec. 2 lab; \$5.00

GEOL 303 Sedimentary Rocks (4) Advanced study of siliciclastic and carbonate rocks. Emphasis on interpretation of depositional environments of sedimentary rocks by using modern analogues. *Preq.* GEOL 202 or instructor permission; 2 lec. 2 lab; \$5.00

GEOL 390 Seminar in Geology (1-4) Discussion of advanced topics in geology.

GEOL 401 Field Methods (4) Study and use of the essential methods of field observations, description, and mapping. Course consists of lecture and detailed field projects in the Portsmouth area. 2 lec. 4 lab; \$10.00

GEOL 485 Senior Project (1-4) In-depth study of a selected topic in geology, culminating in the preparation of a senior paper. *F W Sp*; *preq.* junior or senior standing; \$15.00

GEOL 490 Seminar in Geology (1-4) Discussion of advanced topics in geology. *Preq.* junior or senior standing

GEOL 495 Independent Study (1-4) Independent geology investigation, under the direction of a faculty member. *Preq.* junior or senior standing

GEOL 499 Special Topics in Geology (1-4) Individual or small-group study, under the supervision of instructor, of topics not otherwise available to students. *Preq. junior or senior standing*

Government

GOVT 101 National Government (4) An analysis of the constitutional basis and development of American politics in light of classical democratic theory and contemporary practices; emphasis on the structures, processes, and functions of the national government. *F*

GOVT 199 Special Topics in Government (1-4) Individual or small-group study, under the supervision of instructor, of topics not otherwise available to students. Repeatable for credit. *Offered by arrangement*

GOVT 240 Contemporary Political Ideologies (4) A survey of political thinking, movements, and regimes. Examines the relationship between political visions and the shaping of attitudes, beliefs, and political practice. *Offered every other even year*

GOVT 250 Introduction to Political Science (4) This course, required for all social science majors, explains the fundamentals of the field of political science and offers introductory treatments on the four sub-fields of the discipline (i.e., political theory, comparative politics, international relations, and American government). *F W Sp*

GOVT 299 Special Topics in Government (1-4) Individual or small-group study, under the supervision of instructor, of topics not otherwise available to students. Repeatable for credit. *Offered by arrangement*

GOVT 310 United States Foreign Policy (4) The conceptual bases underlying the development of post-World War II foreign policy, its changing concerns, and its various modes of policy implementation in selected cases and geographic areas (e.g., the Cold War, the Third World, and North/South issues.) *Offered as demand indicates*

GOVT 320 Third World Politics (4) The individual and collective study of the causes of development and underdevelopment, crisis politics, and the prospects for the future of nations in Asia, Latin America, and Africa. *W*

GOVT 330 Mass Media Politics (4) A study of the globalization of the media and its effects on local, national, and international politics; economics; and socialization processes in the United States and other nations. *W*

GOVT 340 European Politics (4) Examines the historical, political, and economic realities of selected nations from an individual and a cross-national perspective with additional attention to the current European Economic Community's supranational integration development process. *Offered as demand indicates*

GOVT 350 National Policy Issues (4) Study of the politics of policy formation and implementation by the national government in selected areas (e.g., foreign policy, welfare, political economy, and environment.) *W; preq./coreq. GOVT 250*

GOVT 370 Global Politics (4) Emphasis on international conflict and cooperation, interdependency, and the increasing importance of economic and transnational relations in the contemporary world. A critical examination of a variety of analytic concepts concerning types of international systems and political behavior. *Offered as demand indicates; preq./coreq. GOVT 250*

GOVT 399 Special Topics in Government (1-4) Individual or small-group study, under the supervision of instructor, of topics not otherwise available to students. Repeatable for credit. *Offered by arrangement*

GOVT 401 State of the World (4) A critical analysis of the relationship between humans and their physical environment at the local, regional, and global level. Surveys issues, identifies problems, and examines actual and possible solutions pertinent to this relationship by utilizing an interdisciplinary approach incorporating students' backgrounds from previous social science courses. Required course for all social science majors. *F W Sp; preq. junior standing*

GEOL 499 - GOVT 401

GOVT 420 - HIST 301

GOVT 420 International Political Economy (4) Historical development of the world economy from 1700s to the present with emphasis on international and transnational actors and institutions, dependency and imperialism, and other selected issues and problems (e.g., trade, debt, and finance). *Infrequently offered; req. junior standing*

GOVT 499 Special Topics in Government (1-4) Individual or small-group study, under the supervision of instructor, of topics not otherwise available to students. Repeatable for credit. *Offered by arrangement; req. eight hours GOVT*

History

HIST 111 American History to 1828 (4) Exploration and colonization; political, social, and economic life of the English colonies to 1763; struggle for independence; constitutional development and the Federalist era; Jeffersonian democracy and the War of 1812; rise of Jackson. *F*

HIST 112 American History, 1828-1900 (4) Jacksonian democracy, territorial expansion, growth of sectionalism, Civil War, reconstruction, impact of expanded Industrial Revolution. *W*

HIST 113 American History Since 1900 (4) Progressive movement, WWI, Republican prosperity, the Great Depression and the New Deal, WWII and problems of the cold war era, turmoil and reform in the 1960's, crisis of confidence in the 1970's, and renewal in the 1980's. *Sp*

HIST 199 Special Topics in History (1-4) Individual or small-group study, under the supervision of instructor, of topics not otherwise available to students.

HIST 201 Ancient History (4) A survey of antiquity from the rise of civilization in ancient Sumeria and Egypt to the end of the Roman empire. *F*

HIST 202 Medieval and Early Modern Europe (4) A survey of European history from the beginning of the Middle Ages to 1789. *W*

HIST 203 Modern Europe (4) A survey of European history from the French Revolution to the present. *Sp*

HIST 225S Civilization and Literature 1 (4) Cross-listed as ENGL 225S. This course is an interdisciplinary introduction to the major thoughts important in the development of western civilization. *Su F W Sp*

HIST 226S Civilization and Literature 2 (4) Cross-listed as ENGL 226S. An interdisciplinary introduction to the major thoughts important in the development of American civilization. *Su F W Sp*

HIST 227S Civilization and Literature 3 (4) Cross-listed as ENGL 227S. An interdisciplinary introduction to the major thoughts of various non-western civilizations. *Su F W Sp*

HIST 260 East Asian History (4) A survey of the history of China and Japan. *Offered on demand*

HIST 275 American Film History (4) Cross-listed as ENGL 275. Chronological study of the influence of American history upon American film, and vice versa. Students become acquainted with the work and themes of some of America's significant film directors and major genres of American popular film. *F and as demand indicates*

HIST 299 Special Topics (1-4) Separate courses repeatable for credit. *Req. HIST 111, 112, and 113, or HIST 201, 202, and 203*

HIST 301 Formation of the American Nation, 1750-1815 (4) Causes and consequences of the American revolution, Confederation period and establishment of new constitutional order, survival and development of the republic in an unfriendly world, 1789-1815. *Offered on demand*

HIST 305 - HIST 420

- HIST 305 From FDR to Reagan (4)** A survey of domestic history from the New Deal to the present. The Great Depression and the New Deal, domestic consequences of World War II and the Cold War, reform efforts of the 1960's, Vietnam trauma, exhaustion of liberalism in the 1970's. *Offered on demand*
- HIST 310 Nazi Germany (4)** An examination of Adolf Hitler, Nazi ideology, World War II, the concentration camps, and genocide. *Offered on demand*
- HIST 320 History of American Foreign Relations (4)** A survey of U.S. foreign relations since 1914. World War I and the Versailles Treaty, interwar efforts to avoid the responsibilities of hegemony, World War II diplomacy and the origins of the cold war, Soviet-American conflict in the Third World, Vietnam War and efforts at detente, exhaustion of the cold war in the 1980's, and possible "end of history." *Offered on demand*
- HIST 325 History of Russia (4)** An overview of Russian history since the Age of Peter the Great. Emphasis on the period from the Crimean War to the present, examining the ambivalent modernization efforts of the late Empire, the collapse of the autocracy in WWI, and subsequent triumphs and travails of the Soviet Experiment. *Offered on demand*
- HIST 326 Economic History of the U.S. (4)** Cross-listed as ECON 326. Analysis of the changes in the economic structure and development of the U.S. from colonial days to the present. Includes a survey of American economic life and the role of entrepreneurship in economic development. *F even years; preq. ECON 101 and 102*
- HIST 330 History of Southern Africa (4)** A survey of the African and European experiences in southern Africa from the 17th Century to the present. *Offered on demand*
- HIST 340 MesoAmerica Before Columbus (4)** Cross-listed as ANTH 340. Survey of MesoAmerican settlement prior to the arrival of the Europeans, including origins of the first hunters and gatherers, development of agriculture, Olmec and Zapotec civilizations, rise and fall of Teotihuacan, and settlement and influence of Mayans, Toltecs, and Aztecs up to the arrival of the Spanish. *F*
- HIST 365 History of English (4)** Cross-listed as ENGL 365 and LING 365. A survey of the patterns and events which have shaped the English language from the time of the Anglo-Saxon to the present. *F; preq. ENGL/LING 360; This course does not fulfill any history course requirements of the history major.*
- HIST 371 Islamic Religion, Culture, and Civilization (4)** Cross-listed as ANTH 371. Survey of the cultural legacy of Islam through an integrated look at the religion, social customs, economic practices, arts, and literature. May be used to meet only one GEP requirement. *W*
- HIST 399 Special Topics in History (1-4)** Individual or small-group study, under the supervision of instructor, of topics not otherwise available to students.
- HIST 401 History of Medicine (4)** An in-depth survey of the history of medicine from antiquity to the modern era. Topics include shamanism and magical methods of healing, exorcism, Chinese acupuncture, classical Greek medicine, and the rise of modern dentistry, obstetrics, surgery, and psychiatry. *F*
- HIST 410 Intellectual History 1 (4)** Part one of a course examining humanity's ideas about the cosmos, the earth, and the human species. Topics in this course include creation myths, the history of astronomy, concepts of the afterlife, and the ideas about "imaginary places" (from Atlantis to Shambala). *W*
- HIST 411 Intellectual History 2 (4)** Topics in this course include the history of geology and ideas about the earth, "creation of man" legends and the ideology of Darwinism, "the devil, the Antichrist, and perceptions of evil," ideas about "imaginary creatures" (from unicorns to vampires), and scientific theories about the "end of the world." *Sp*
- HIST 420 Middle East in Modern Times (4)** An examination of recent conflicts and turmoil in the Middle East through the following sequence: concise overview of Middle East history, relationships between today's turmoil and the development of nationalism and emergence of nation-states, specific conflicts like the Soviet invasion of Afghanistan, Arab-Israeli conflict, and the Gulf war. *Offered on demand*

HIST 499 - HPER 182

HIST 499 Special Topics in History (1-4) Individual or small-group study, under the supervision of instructor, of topics not otherwise available to students. Separate courses repeatable for credit. *Preq.* HIST 111, 112, and 113, or HIST 201, 202, and 203

Health, Physical Education, and Recreation

HPER 100 Dance: Concert and Recreational (1) Demonstration of various forms of dance and appreciation of their development. *Su F W Sp*

HPER 103 Introduction to Human Nutrition (2) Study of nutrients, nutritional diets, deficiencies, and the role of nutrition in promoting health. *F*

HPER Physical Education Activities (1) Basic rules and fundamentals for each of the following activities. Special emphasis on strategies, team, and individual play. An appreciation of each of the activities is developed to carry over into later life.

- HPER 104 Beginning Table Tennis**
- HPER 105 Archery** *F W Sp*
- HPER 106 Beginning Ballet 1**
- HPER 107 Beginning Ballet 2**
- HPER 111 Basketball** *W Sp*; \$5.00
- HPER 113 Billiards** *F W Sp*
- HPER 115 Bowling** *F W Sp*
- HPER 116 Gymnastics** *Su F W Sp*
- HPER 117 Volleyball** *F W Sp*; \$5.00
- HPER 119 Walleyball** *Su F W Sp*; \$5.00
- HPER 120 Beginning Golf** *Su F Sp*
- HPER 121 Intermediate Golf** *Sp*
- HPER 122 Handball** *F*
- HPER 124 Softball** *Sp*; \$5.00
- HPER 125 Soccer** *Su F Sp*; \$5.00
- HPER 130 Beginning Racquetball** *Su F W Sp*
- HPER 131 Intermediate Racquetball** *F W Sp*
- HPER 132 Advanced Racquetball** *Sp*
- HPER 140 Beginning Tennis** *Su F Sp*
- HPER 141 Intermediate Tennis** *Su Sp*
- HPER 142 Advanced Tennis** *Su Sp*
- HPER 149 Badminton** *F*
- HPER 150 Swimming** *Su F W Sp*
- HPER 151 Intermediate Swimming** *Su F W Sp*
- HPER 152 Life Saving** *Su F W Sp*
- HPER 153 Advanced Life Saving** *Su F W Sp*
- HPER 154 Life Guard Training** *Su F W Sp*
- HPER 155 Advanced Swimming** *Su F W Sp*
- HPER 156 Fitness Swimming** *F*
- HPER 157 Swimmecize** *F W Sp*
- HPER 158 Diving** *F Sp*
- HPER 159 Water Volleyball** *Sp*
- HPER 160 Dance** *F W Sp*
- HPER 161 Yoga** *Su F W Sp*
- HPER 162 Advanced Yoga** *Su F W Sp*
- HPER 163 Modern Dance**
- HPER 165 Beginning Gymnastics** *F*
- HPER 170 Karate** *Su F W Sp*
- HPER 171 Judo** *Sp*
- HPER 172 Women's Self Defense** *F W Sp*
- HPER 180 Jogging** *Su F Sp*
- HPER 181 Skiing** *W*
- HPER 182 Orienteering** *F Sp*

HPER 183 - HPER 239

- HPER 183** Rock Climbing *F Sp*
HPER 184 Caving *F Sp*
HPER 185 Backpacking *F Sp*
HPER 186 Cycling *Su F Sp*
HPER 187 Conditioning and Weight Training *Su F W Sp*
HPER 188 Conditioning and Weight Training/Nautilus *Su F W Sp*
HPER 189 Horseback Riding
HPER 190 Beginning Scuba *F*
HPER 191 Scuba—Open Water *W*
HPER 197 Canoeing *Sp*
- HPER 198** **Orientation to Athletic Training (2)** Introduction to the profession of athletic training, the roles and functions of the Certified Athletic Trainer, and standards of practice of the National Athletic Trainers Association and the State of Ohio Athletic Trainers Licensing Board. *F*
- HPER 200** **Introduction to Recreation (4)** A study of the general concepts of recreation, including definitions, history, legal basis, current development, and present importance of recreation in our society. Management and administration of parks and recreation organizations. Laboratory introduction to a number of recreation experiences. 3 *lec. 3 lab*
- HPER 201** **Introduction to Sports Management (3)** An introduction to the various aspects of athletics, intramural, and recreation administration. *F*
- HPER 202** **Personal and Community Health (4)** Cross-listed as BUHE 202. Fundamentals, practices, and appreciation of healthful living. Designed to incorporate the principles of scientific health information and promote desirable attitudes and practices in individuals, parents, and teachers. *Su F W Sp*
- HPER 203** **Human Nutrition (4)** Cross-listed as BUHE 203. A study of nutrients, including sources, composition, function, and metabolism in the human body. The human life cycle is considered in planning appropriate diets. *Su F W Sp*
- HPER 220** **Foundations of Athletic Training (3)** Foundations of the prevention, assessment, treatment, and rehabilitation of athletic injuries. *Sp; coreq. HPER 222 for students in athletic training concentration.*
- HPER 222** **Athletic Training Laboratory (2)** Study of strapping and taping techniques, construction of orthotics and orthopedic appliances, and fitting of protective equipment commonly used in the profession of athletic training. *Su F W Sp; coreq. HPER 220 for students in athletic training concentration; \$20.00*
- HPER 227** **First Aid (4)** Cross-listed as BUHE 227. Provides information and practical experience dealing with hemorrhaging, traumatic shock wounds, respiratory failure, serious illnesses, transportation of the sick and injured, cardiopulmonary resuscitation, splinting of broken bones, hypothermia, specific injuries, choke-saving, poisoning, burns, heat illnesses. Students are certified in CPR (infant and adult) through the American Heart Association. *F W Sp; \$4.00*
- HPER 228** **Law and Liability in Sports (4)** Designed to provide information concerning the role of law in sport and physical activity for those who must deal with and manage a variety of legal concerns on a routine basis. *W alternating years*
- HPER 235** **Orientation to Recreation Employment (1)** Resume writing, job application, interviewing, contact follow-up, letter writing, job hunting strategies, and potential employers. *On demand; 1 lec. 1 lab*
- HPER 236** **Field Experience in Recreation (2-6)** Supervised work experience while gaining skills and knowledge in the field of recreation. *F*
- HPER 239** **Athletic Officiating—Football (3)** Rules, mechanics, and procedures in officiating. Practice under actual game conditions. State certification upon successful completion of state examination. OHSSA fee for certification and books.

HPER 240 - HPER 322

- HPER 240 Athletic Officiating—Basketball (3)** Rules, mechanics, and procedures in officiating. Practice under actual game conditions. State certification upon successful completion of state examination. OHSSA fee for certification and books.
- HPER 241 Athletic Officiating—Baseball (3)** Rules, mechanics, and procedures in officiating. Practice under actual game conditions. State certification upon successful completion of state examination. OHSSA fee for certification and books.
- HPER 242 Athletic Officiating—Volleyball (3)** Rules, mechanics, and procedures in officiating. Practice under actual game conditions. State certification upon successful completion of state examination. OHSSA fee for certification and books.
- HPER 245 Introduction to Coaching (2)** Introduction to high school interscholastic athletics, including history, structures, job opportunities, and contemporary programs.
- HPER 250 Recreation Leadership (4)** Lectures, discussion, and group dynamics in social recreation, including games, sports skills, dance, arts and crafts, nature studies, setting up various types of tournaments, and practical work in community organizations.
- HPER 251 Clinical and Field Experiences in Athletic Training (3)** Practical experience in the field and clinical setting. Student trainers perform duties and techniques relevant to the field of athletic training under the supervision of the certified/licensed athletic trainer. Due to the nature of this course, a maximum of 36 credit hours is permitted. Grades are based on the completion of 135 hours per quarter. A grade of pass/no-credit is given. *Su F W Sp; req. or coreq. HPER 220 and 222*
- HPER 252 Youth and Sports (3)** Exploration of opportunities, controversies, organization, safety, values, rules, leadership, benefits, and settings of youth sports programs. *F*
- HPER 255 Aquatic Recreation Leadership (4)** Study of water-related recreational facilities such as marinas, swimming areas, and fishing. Consideration is given to boating laws, boat operation and safety, and all forms of water recreation. *F W Sp; 2 lec. 6 lab*
- HPER 260 Outdoor Recreation (4)** Several aspects of outdoor recreation, including concepts of feasibility, interpretation, and personal recreation equipment use and care. Laboratory exercises. *Coreq. HPER 200 or permission of instructor; 2 lec. 6 lab*
- HPER 261 Foundations of Physical Exercise (2)** Presents scientific information concerning the need for physical activity and a personal fitness prescription. Provides background information on the eleven parts of fitness. Students are shown step-by-step how to work out a lifetime fitness program that meets their needs and interests. *W*
- HPER 270 Physical Education for the Elementary Classroom (4)** Lab and lecture experience for teaching physical education in the elementary schools. Lab experience revolves around methods of presenting games, self-testing activities, rhythmic, and innovative devices in the elementary grades. Designed for students seeking elementary education certification. *F W Sp; req. EDUC 110; \$25.00*
- HPER 281 Administration of Intramural Athletics (4)** Organizing and administering a program of intramural sports for all age levels. Designed especially for elementary and secondary teachers. *Req. education and sports studies majors*
- HPER 295 Independent Study (2)** Study, observation, and research in selected physical education fields. Under the direction of HPER faculty member. *Su F W Sp; req. upper division HPER classes*
- HPER 320 Prevention and Assessment of Upper Extremity Injuries (3)** Study of techniques in prevention, assessment, and management of common upper extremity injuries in athletics. *Sp; req. HPER 220*
- HPER 322 Prevention and Assessment of Lower Extremity Injuries (4)** Study of techniques in evaluating, preventing, and managing common lower body injuries and illnesses in athletics. *W; req. HPER 222; \$25.00*

- HPER 325 Rehabilitation of Athletic Injuries (3)** Study of principles and procedures of therapeutic exercises. Topics include muscle testing, goniometry, flexibility, and progressive resistance exercises in the rehabilitation of common injuries occurring in athletics. *W; preq. HPER 320*
- HPER 326 Therapeutic Modalities in Sportsmedicine (3)** Theory and therapeutic application of modalities such as cryotherapy, thermotherapy, low and high volt electrical currents, diathermy, intermittent compression, traction, and massage in the rehabilitation of athletic injuries. *Sp; preq. HPER 320*
- HPER 340 Coaching of Volleyball (2)** Theory of coaching volleyball. Analysis of skills, strategies, methods, duties, and responsibilities.
- HPER 341 Coaching of Basketball (2)** Theory of coaching basketball. Analysis of skills, strategies, methods, duties, and responsibilities.
- HPER 342 Coaching of Football (2)** Theory of coaching football. Analysis of skills, strategies, methods, duties, and responsibilities.
- HPER 343 Coaching of Track (2)** Theory of coaching track. Analysis of skills, strategies, methods, duties, and responsibilities.
- HPER 344 Coaching of Softball (2)** Theory of coaching softball. Analysis of skills, strategies, methods, duties, and responsibilities.
- HPER 352 Sports for the Disabled (3)** A presentation of sports programs and assessments that can be made available to the disabled. How to organize and administer such sporting events as competing aquatics, wheelchair basketball, archery, bowling, track and field, softball, and tennis. *Sp*
- HPER 360 Drugs/Substance Abuse (4)** Cross-listed as BUHE 360, PSYC 360, and SOCI 360. An in-depth study of alcohol, tobacco, and other drugs and how chemical dependency on these drugs can affect individual performance and behavior. *Su F W Sp*
- HPER 366 Aquatics Management (4)** A survey of the recreational aquatics environment. Hands on training in filtration systems and their general operation, an understanding of federal and state guidelines and licenser for pool operation and maintenance. Legal aspects of the aquatics area. Staffing requirements and training of aquatics personnel for indoor and outdoor facilities. *F; preq. HPER 392*
- HPER 368 Introduction to Sport Law (4)** Survey of the legal framework of the athletic environment. The nature of the legal system and law pertaining to sports, including tort law, contractual agreements, and civil law. *W alternating years*
- HPER 385 Psychology of Sports (3)** Offers students the opportunity to learn correct principles and applications of sport psychology. Provides a better understanding of how individuals can enhance peak performance through recent advances in sport psychology. *Sp*
- HPER 386 Sociology of Sport (3)** Designed to investigate the role physical education and sports play in the lives of individuals, societies, and countries. Considers the context of sport, focusing on the meaning of what happens in sport, where sport fits—or does not fit—into society and why. *W*
- HPER 390 Sports and Fitness Management 1 (4)** An advanced study of the facilities required for the recreational environment. An analysis of indoor and outdoor designs and utilization. An overview of the personnel process, staffing requirements, and staff development procedures. A study of activity programming for the recreational environment, including class structure, tournament procedures, proper selection of activities, and equipment needed and its care and storage. *F; preq. HPER 201 and BUMG 310*
- HPER 392 Sports and Fitness Management 2 (4)** An advanced study of sports marketing strategies for the recreational environment, both internal and external. Promotional guidelines and discussion of promotional activity. Study of the budgetary process, differentiations of budget styles, and implementation of the budgetary process in both the private and public sector. *W; preq. HPER 390*

HPER 325 - HPER 392

HPER 396 - HPER 499

HPER 396 Practicum 1 in Athletic Training (2) Application of theories and techniques of athletic training in a variety of on campus clinical settings. Classroom periods focus on the discussion of case studies, special procedures and techniques, and problem solving from the students' clinical experiences. *F; req. HPER 320, 322, and admission to the athletic training program*

HPER 397 Practicum 2 in Athletic Training (2) Continuation of HPER 396. Further application of theories and techniques of athletic training in a variety of on campus clinical settings. Classroom periods focus on the discussion of case studies, special procedures and techniques, and problem solving from the students' clinical experiences. *W; req. HPER 396 and admission to the athletic training program*

HPER 398 Practicum 3 in Athletic Training (2) Continuation of HPER 397. Further application of theories and techniques of athletic training in a variety of on campus clinical settings. Classroom periods focus on the discussion of case studies, special procedures and techniques, and problem solving from the students' clinical experiences. *Sp; req. HPER 397 and admission to the athletic training program*

HPER 407 Practicum 1 (4) Practical training in general operation of recreational setting. Includes activity preparation, personnel evaluation, and budget analysis. Also includes an on campus seminar to discuss issues relating to the profession. Summative assessment includes a combination of performance checklists and evaluations by the on-site supervisor. *Su F W Sp; req. senior rank and faculty approval*

HPER 420 Physiology of Exercise (4) Study of the physiological response of the cardiovascular, respiratory, endocrine, neural, and muscular systems in the human body during exercise. *Sp; req. BIOL 162, 310, and 311*

HPER 422 Prevention and Assessment of Non-Orthopedic Injuries (4) Study of techniques in prevention, assessment, and management of common non-orthopedic injuries and illnesses in athletics. *Sp; req. HPER 222*

HPER 428 Athletic Training Administration (4) Study of standards, policies, and procedures in the organization and administration of an athletic training program. *F*

HPER 450 Organization and Administration of Sport Programs and Athletics (4) Study of policies, standards, and procedures in the organization and administration of physical education and athletic programs. *Sp; req. BUMG 310*

HPER 495 Special Topics (1-4) Study, under the supervision of instructor, of topics not otherwise available to students. *Sp*

HPER 496 Internship 1 Sportsmedicine (6) Level III Fieldwork. 12 weeks of supervised in-depth field experience in a hospital based, physician office, or private practice clinical setting. Students are on site 20 hours each week. Summative assessment includes a combination of performance checklists and evaluations by the on site clinical supervisor. *F; req. completion of all athletic training program level I and II competencies*

HPER 497 Internship 2 in Sportsmedicine (6) Level III Fieldwork. 11 weeks of supervised in-depth field experience in a hospital based, physician office, or private practice clinical setting. Students are on site 20 hours each week. Summative assessment includes a combination of performance checklists and evaluations by the on site clinical supervisor. *W; req. completion of all athletic training program level I and II competencies*

HPER 498 Internship 3 in Sportsmedicine (6) Level III Fieldwork. 11 weeks of supervised in-depth field experience in a hospital based, physician office, or private practice clinical setting. Students are on site 20 hours each week. Summative assessment includes a combination of performance checklists and evaluations by the on site clinical supervisor. *Sp; req. completion of all athletic training program level I and II competencies*

HPER 499 Practicum 2 (6) Student works with a current fitness manager to gain insight on program and facility operation, budgetary implementation, and to assist in the daily operation of a fitness facility. This course also includes an on campus seminar to discuss issues relating to the profession. Summative assessment includes a combination of performance checklists and evaluations by on-site supervisor. *Sp; req. HPER 392, 407, senior rank, and faculty approval*

Journalism

JOUR 105 Introduction to Mass Communication (4) Cross-listed as SPCH 105. Introduces all forms of mass communication, including newspapers, magazines, radio/television, book publishing, public relations, advertising, and photojournalism. Begins with an analysis of the communication process and ends with media career opportunities. *Offered on demand*

JOUR 199 Topics in Journalism (1-4) Study of selected newspaper topics not otherwise available. Includes hands-on experience in various newspaper positions. *Offered on demand*

JOUR 23 News Reporting and Writing (4) Methods of gathering and evaluating news and writing news stories. Practice work includes covering assignments and writing news copy. *Offered on demand; req. typing proficiency*

JOUR 289 Magazine Feature Writing (4) Writing and marketing free-lance magazine articles of various types, including personal narrative, informative, how-to, historical, personality sketch, investigative, and interpretative. Students learn how to generate ideas, get photos, propose article ideas to editors, and survey regional and specialty magazine markets. *Offered on demand*

JOUR 299 Topics in Journalism (3) Study of various topics in journalism not otherwise available to students. *Offered on demand*

Linguistics

LING 360 Introduction to Language and Linguistics (4) Cross-listed as ENGL 360. A discussion and analysis of the fundamental properties and processes of the world's languages. A review of the major systems and features which constitute language. A discussion of language change, typology, and aspects of language acquisition.

LING 362 Patterns of English (4) Cross-listed as ENGL 362. An examination of various English phonological and spelling patterns, followed by questions of variation and usage. Aspects of English phrase, clause, and sentence structure are also examined. *W; req. ENGL/LING 360*

LING 365 History of English (4) Cross-listed as ENGL 365 and HIST 365. A survey of the patterns and events which have shaped the English language from the time of the Anglo-Saxon to the present. *F; req. LING/ENGL 360; This course does not fulfill any history course requirements of the history major.*

LING 455 English Language in Society (4) Cross-listed as ENGL 455. Language variation by individual speakers is analyzed in relation to the reasons and extent of variation, paying particular attention to English. Then the processes and characteristics associated with different contact and social varieties of English are detailed. Finally, English geographic variation and patterning is reviewed. *Req. ENGL/LING 360*

Mathematics

SPECIAL NOTE: Admission to MATH courses is determined either by placement testing or by having successfully completed a prerequisite course. Please see the diagram on page 76. Questions about placement into appropriate courses should be directed to the Department of Mathematical Sciences (355-2301). Inquiries about placement testing should be directed to the Learning Center (355-2499).

MATH 099 Fundamental Mathematics (4) A brief review of the fundamentals of arithmetic, including addition, subtraction, multiplication, and division of integers and rational numbers. An introduction to the elementary concepts of basic algebra with emphasis on manipulations of algebraic expressions, solutions to simple equations, graphs, and formula rearrangement. (Does not count toward a degree.) *Su F W Sp; req. placement*

JOUR 105 - MATH 099

MATH 101 - MATH 141

MATH 101 Basic Algebra (4) A course for students with a good background in arithmetic but little or no background in algebra. Operations with integers, number properties, scientific notation, solving linear equations and inequalities and graphing the solutions on real line, operations with polynomials, laws of exponents, and an introduction to square roots. *Su F W Sp; req. placement or MATH 099*

MATH 105 Plane Geometry and Algebra (4) A course for students with a good background in algebra but little or no background in geometry. Graphing; logical thinking; problem-solving; measurement; area; perimeter and volume of common geometric figures; properties of lines and polygons; and work at a more advanced level with algebra, including work with geometrically related topics. *Su F W Sp; req. placement or MATH 101*

MATH 106 Elements of Algebra and Geometry (4) An accelerated course for students with sound backgrounds in both algebra and geometry who are in need of review. This course surveys the material covered in MATH 101 and MATH 105. Solving linear equations; graphing; operations with exponents, polynomials, rational expressions, and radicals; inequalities; basic properties of measurement, parallel lines, similar triangles, and right triangles; and word problems involving the above topics. *Offered on demand; req. placement*

MATH 110S Mathematics Core Course (4) This course addresses questions about the nature and historical development of mathematical thought and knowledge and the impact of mathematics on modern life. The course focuses on problem solving techniques, heuristics, critical thinking, and the collection and interpretation of data. In addition, one or more of the following topics is included: probability, statistical inference, symbolic logic, graph theory, numeration systems, measurement, basic programming, linear programming, and spreadsheet software with business applications. *Su F W Sp; req. placement or MATH 105 or 106; 3 lec. 1 discussion/activity; \$10.00*

MATH 125 Business Mathematics (4) Emphasis on estimating answers, percentages, reconciliation of a checking account, mark-up, taxes, depreciation, payroll and payroll deductions, inventory evaluation, financial statements, simple and compound interest on investments and loans, and use of calculators. *F W Sp; req. placement or MATH 101*

MATH 130 Intermediate Algebra (4) Presentation of a variety of techniques for simplifying algebraic expressions, solving equations and word problems, and graphing. Topics include linear functions, right triangle trigonometry and its applications, rational expressions, rational exponents, and quadratic equations. *Su F W Sp; req. MATH 105, 106, or placement*

MATH 131 College Algebra (4) This precalculus course focuses on functions and their graphs. Students learn the basic properties of linear, polynomial, rational, exponential, and logarithmic functions. Topics also include conditionally defined functions, inverse functions, and operations on functions. Students learn to use functions and graphs as tools for modeling. *Su F W Sp; req. MATH 130 or placement*

MATH 132 Trigonometry and Analytic Geometry (4) This precalculus course provides an in-depth study of the trigonometric functions, including graphs, equations, identities, and applications. Conic sections are also included. *Su F W Sp; req. placement or MATH 131*

MATH 140 Elementary Topics in Mathematics 1 (5) Problem-solving, sets, concepts of logic, binary operations, systems of numeration, number theory, rational numbers, real numbers, measurement, and use of calculators and computers. *Su F W Sp; req. MATH 110S; \$10.00*

MATH 141 Elementary Topics in Mathematics 2 (5) Basic algebraic work with equations and inequalities in one unknown, systems of equations, metric and nonmetric geometry, coordinate geometry, introduction of statistics and probability, problem-solving, and computer use. *Su F W Sp; req. MATH 120; \$10.00*

MATH 150 - MATH 300

- MATH 150 Principles of Statistics (4)** Cross-listed as PSYC 150 and SOCI 150. Introduction to the vocabulary, concepts, formulas, and presentation of statistics as applied to business, education, and science. Topics include measures of central tendency and dispersion, definition of classical probability, probability distributions with emphasis on binomial and normal distribution. Sampling practices and theory, calculator and computer use. This course satisfies the quantitative reasoning requirement of Shawnee State University's General Education Program. *Su F W Sp; preq. placement or MATH 105 or 106; \$10.00*
- MATH 170 Applied Finite Mathematics (4)** Applications of mathematical models for students in business, economics, and life and social sciences. Models selected from linear functions and systems, matrices, linear programming, mathematics of finance, probability, markov chains, and game theory. *Su F W Sp; preq. MATH 130 or placement; \$10.00*
- MATH 190 Brief Calculus with Applications (4)** An intuitive introduction to differential and integral calculus with an emphasis on applications in business, economics, and life and social sciences. *W Sp; preq. MATH 130 or MATH 170 or placement; \$10.00*
- MATH 201 Calculus 1 (4)** This is the first course in the calculus sequence. The main topics are functions, limits, derivatives, and applications. This course satisfies the quantitative reasoning requirement of Shawnee State University's General Education Program. *Su F W Sp; preq. placement or MATH 132*
- MATH 202 Calculus 2 (4)** Second course in the calculus sequence. The emphasis is on integration. Contents include integration of algebraic functions and applications and differentiation and integration of exponential, logarithmic, trigonometric, and hyperbolic functions. *Su F W Sp; preq. MATH 201*
- MATH 203 Calculus 3 (4)** The third course in the calculus sequence. Indeterminate forms, improper integrals, Taylor's Formula and infinite series, plane curves, and polar coordinates. Introduction to vectors. *Sp; preq. MATH 202*
- MATH 204 Calculus 4 (4)** The last course in the calculus sequence. The emphasis is on multivariable calculus. Contents include some discussion and applications of vector-valued functions, partial derivatives, multiple integrals, and other topics in vector calculus. *F; preq. MATH 203*
- MATH 220 Discrete Mathematics (4)** Introduces the student to various topics from discrete mathematics. Topics include logic; induction; sets, binary relations, and functions; graph theory; proofs; combinatorics and finite probability. This course satisfies the quantitative reasoning requirement of Shawnee State University's General Education Program. *Sp; preq. MATH 131*
- MATH 221 Discrete Mathematics 2 (4)** A continuation of MATH 220. In-depth study of graph theory. Topics include basic counting techniques, recurrence equations, trees and spanning trees, and graphs. *Offered on demand; preq. MATH 220 or instructor consent*
- MATH 230 Linear Algebra (5)** Solutions to linear systems, matrices and matrix algebra, determinants, n-dimensional real vector spaces and subspaces, linear mappings, diagonalization. Techniques and computational skills emphasized. *W; preq. MATH 201*
- MATH 250 Statistics 1 (4)** Introduction of descriptive statistics and probability. Applications of probability distributions with emphasis on binomial, Poisson, and normal distributions. Introduction to interval estimation and hypothesis testing. Computer use in student project applications. This course satisfies the quantitative reasoning requirement of Shawnee State University's General Education Program. *Su F W Sp; preq. MATH 201 (preferably with a grade of "C" or better); \$10.00*
- MATH 290 Seminar in Mathematics (1-4)** Discussion of topics in mathematics.
- MATH 299 Special Topics in Mathematics (1-4)** Individual or small-group study, under the supervision of instructor, of topics not otherwise available to students.
- MATH 300 History of Mathematics (4)** Survey from Babylonian and Egyptian mathematics to 20th century mathematics with emphasis on development of algebra, geometry, and number theory. *Sp 1998; preq. MATH 201 or permission*

MATH 301 - MATH 420

MATH 301 Ordinary Differential Equations (4) An introduction to ordinary differential equations with emphasis on technique and application. Topics include existence and uniqueness of solutions, first order equations, linear differential equations, and systems. Analytical and numerical methods. *F 1997; preq. MATH 203*

MATH 305 Mathematics Enrichment for the Teacher (4) The use of manipulative models in the classroom. Computer software selection and its integration into the curriculum. Introductory programming. An introduction to mathematics games and how to use them in teaching mathematics to children. *F; preq. MATH 121 or permission; \$10.00*

MATH 320 Foundations of Geometry (4) Introduction to axiomatic mathematics through a variety of geometry types, including a consideration of the postulates of Euclid, surface topology, and finite geometry. The development of plane Euclidean and non-Euclidean geometries using appropriate models and the consideration of various geometric configurations. *Sp 1999; preq. MATH 201*

MATH 325 Introduction to Number Theory (4) Selected number systems. Investigation of properties of natural numbers. Topics include proof techniques, prime factorization, Euclidean algorithm, Diophantine equations, congruences, and divisibility. *F 1998; preq. MATH 201 and 220*

MATH 335 Intermediate Analysis (4) In-depth study of limits, sequence, series, continuity, mean-value theorem, differentiation, and Riemann integration. *F 1997; preq. MATH 203*

MATH 350 Statistics 2 (4) A course in multivariate analysis. Includes simple and multiple linear regression, analysis of variance, and categorical data analysis. Use of statistical computer software and course projects. *W 1998; preq. MATH 250; \$10.00*

MATH 360 Introduction to Probability (4) Classical probability, probability theory, conditions of probability, random variables and distribution, characteristic function, central limit theorem, and Law of Large Numbers. *F 1997; preq. MATH 203*

MATH 370 Operations Research 1 (4) Cross-listed as BUMG 370. An introduction to the general nature, history, and philosophy of operations research. A study of the theory of linear programming, the simplex algorithm, and applications. A series of special linear programming problems, such as optimal assignment, transportation, transshipment, network flow, minimal spanning trees, shortest path, PERT methods, and traveling salesperson. *W 1999; preq. MATH 230 or BUMG 355 or instructor consent; \$10.00*

MATH 371 Operations Research 2 (4) Cross-listed as BUMG 371. A continuation of MATH 370. Dynamic programming and integer programming are studied (or finished if started in MATH 370). Stochastic models of operations research such as markov chains, queuing theory, and simulation are studied. *Sp 1999; preq. MATH 370 and MATH 150 or instructor consent*

MATH 405 Mathematics Enrichment for the Secondary Teacher (4) Students explore and communicate secondary (grades 7-12) mathematical concepts from an advanced perspective through the use of manipulatives, technology, and exploratory learning. *W; preq. admission to teacher education program, MATH 220, 230, and 320; \$10.00*

MATH 410 Modern Algebra 1 (4) Treatment of groups, permutations, subgroups, isomorphisms, homomorphisms, and quotient groups. *F 1998; preq. MATH 230; MATH 335 also recommended.*

MATH 411 Modern Algebra 2 (4) Treatment of rings and fields, subrings, ideals, homomorphisms, isomorphisms, and Galois theory. *W 1999; preq. MATH 410*

MATH 420 Matrix Theory (4) Brief review of Linear Algebra. Matrix functions and applications, including linear programming, inner products, diagonalization, generalized inverses, and applications to differential equations and optimization. Numerical linear algebra. *Sp 1999; preq. MATH 230 or permission*

MATH 430 Numerical Analysis (5) Polynomial interpolation and approximation, numerical integration and differentiation, numerical solution to differential equations. Computer use emphasized. This course is strongly recommended for those who are interested in or would like to pursue a career in applied mathematics, actuarial or computer sciences. *F 1998; preq. MATH 202 and one computer programming language; MATH 203 and/or 301 are recommended; \$10.00*

MATH 440 Mathematical Models (4) Construction and analysis of mathematical models and their use in investigation of physical, chemical, biological, engineering, statistical, social, and environmental problems. This analysis is conducted using calculus-based techniques and applicable computer models. *W 1998; preq. MATH 202; \$10.00*

MATH 450 Complex Variables (4) Algebra of complex numbers, analytic functions, mappings, Cauchy Integral Theory, Residue theory, and applications. *W 1998; preq. MATH 204*

MATH 460 Real Analysis (4) Topics include set theory, real number theory, compactness, completeness, Lebesgue measure and general introduction of metric spaces. *W 1998; preq. MATH 335*

MATH 470 Methods of Teaching Mathematics in Secondary Schools (4) Cross-listed as EDUC 430. Designed to acquaint students with the practices and problems involved in teaching secondary (grades 7-12) mathematics. Problem solving, inquiry based teaching, and the use of technology are emphasized. General teaching methods, patterns of instruction, and diagnostic techniques, as they apply to the secondary mathematics curriculum, are used in a laboratory context and practiced in field experiences. *Sp; preq. MATH 405, at least 56 credit hours of required mathematical content, and admission to teacher education program; coreq. EDUC 410; \$25.00*

MATH 480 General Topology (4) Concepts of general topological space and metric space, compact and connected spaces, and separation axioms. *Sp 1998; preq. MATH 335*

MATH 490 Advanced Seminar in Mathematics (1-4) Discussion of advanced topics in mathematics.

MATH 495 Undergraduate Research (1-4) Independent mathematics investigation under the direction of a faculty member.

MATH 496 Senior Research Project 1 (1) The first of a two-course sequence, taken near the end of the student's bachelor program. The student's in-depth investigation of a mathematical topic culminates in the presentation of a senior paper. *Su F W Sp; preq. department permission*

MATH 497 Senior Research Project 2 (3) Continuation of MATH 496. *Su F W Sp; preq. MATH 496*

MATH 499 Special Topics in Mathematics (1-4) Individual or small-group study, under the supervision of instructor, of topics not otherwise available to students.

Medical Laboratory Sciences

MLSC 310 Clinical Microbiology 2 (3) In-depth theory and application of clinical laboratory techniques used to identify bacteria, fungi, parasites, and viruses pathogenic to man. *Preq. MLTC 207*

MLSC 315 Blood Banking 2 (4) Theory and application of immunologic techniques as they pertain to blood grouping, antibody identification, and blood transfusion. *Preq. MLTC 202*

MLSC 340 Procedure Evaluation and Quality Control (2) Use of statistical analysis in method selection and comparison, determining method accuracy and reproducibility, and methods of quality control/quality assurance. *Preq. junior standing in the MLS program*

MLSC 350 Clinical Instrumentation (3) Principles and operation of clinical laboratory instruments. *Preq. junior standing in the MLS program*

MATH 430 - MLSC 350

MLSC 355 - MLTC 112

MLSC 355 Laboratory Safety (2) Laboratory safety issues are addressed to include current OSHA/EPA requirements; patient, employee, and visitor safety; good laboratory hygiene; housekeeping; personal barrier protection; chemical hazards; compressed gases; microbiological hazards; fire prevention and control; electrical safety radiation hazards; hazardous waste disposal; emergency planning; employee training; and quality assessment and improvement.

MLSC 360 Clinical Laboratory Enrichment (3) Clinical practicum in a specialized clinical laboratory setting not provided by affiliated hospitals. Examples of enrichment sites may be regional blood centers, virology and mychology labs, and reference and forensic labs. *Preq. junior standing in the MLS program*

MLSC 410 Clinical Correlations 1 (4) Study of clinical laboratory procedures as they relate to health and disease. Testing in the areas of hematology, chemistry, blood banking, microbiology, serology, urinalysis, and hemostatis as they relate to pathological conditions. *Preq. senior standing in the MLS program*

MLSC 415 Clinical Correlations 2 (4) Continuation of MLSC 410. Study of diagnostic laboratory procedures as they relate to pathological conditions. *Preq. senior standing in the MLS program*

MLSC 420 Laboratory Management (3) A study of organizational goals and objectives in a clinical laboratory setting. Topics include planning/forecasting, determining equipment space, personnel needs, financial management, inventory control, personnel management, and quality assurance in a clinical laboratory. *Preq. senior standing in the MLS program*

MLSC 425 Clinical Education Methodology (3) An overview of education in the clinical laboratory to include educational roles for the medical technologist, instructional planning, writing and classification of objectives, teaching strategies, test development, and analysis. *Preq. senior standing in the MLS program*

MLSC 430/440 Clinical Practicum (6) Clinical practicum designed to prepare students for career entry positions as clinical laboratory scientists/medical technologists. Students develop technical and professional skills in the areas of clinical chemistry, hematology, microbiology, blood banking, and urinalysis. *Preq. senior standing in the MLS program*

MLSC 490 Medical Laboratory Science Seminar (4) Presentation of advanced topics in clinical laboratory science. *Preq. senior standing in the MLS program*

MLSC 499 Selected Topics in Medical Laboratory Science (2-10) Current topics of interest in clinical laboratory science. Topics selected are of interest to students and practicing technologists alike. Technical and/or professional issues and topics are addressed. *Preq. senior standing in the MLS program*

Medical Laboratory Technology

MLTC 111 Medical Laboratory Orientation (2) Introduction to the profession of Medical Laboratory Technology, including history, philosophy, development, educational requirements, current trends, and role and responsibilities of the medical lab technicians. Ethics, employment opportunities, certification and licensure, professional organizations, interpersonal relationships, basic medical terminology, as well as the safe handling of potentially infectious materials. *F; preq. admission or alternate status in the medical laboratory program*

MLTC 112 Basic Laboratory Skills (3) Introduction to basic laboratory procedures and techniques. Emphasis is placed on phlebotomy, microscopy, spectrophotometry, pipetting, use of centrifuges, analytical balances, bookkeeping, lab safety, and basic laboratory instruments. Laboratory mathematics, particularly in solution preparations, dilution, calculation of concentrations, and standard curve are included. *W; preq. BIOL 151, CHEM 141, and MLTC 111; 2 lec. 3 lab*

- MLTC 201 Urinalysis (3)** Physical, chemical, and microscopic examination of urine. Theory and applications of various laboratory tests in relation to kidney function. Brief discussion of other important body fluids. *F; preq. BIOL 162 (or 310 and 320) and MLTC 112; 2 lec. 3 lab*
- MLTC 202 Immunoserology (3)** Introduction to basic immunology with emphasis on the principles and applications of serological techniques in diagnostic tests. *Su; Preq. BIOL 162 (or 310 and 320) and MLTC 112; 2 lec. 3 lab*
- MLTC 203 Blood Banking (4)** Lectures and laboratory procedures in blood banking. Principles of blood grouping and human blood group genetics. Routine procedures for pretransfusion testing, antibody screening, and identification. Donor selection, blood collection, and processing are discussed. Hemolytic diseases of the newborn, preparations of blood components, and their storage and utilization are also introduced. *F; preq. MLTC 202; 2 lec. 6 lab; \$10.00*
- MLTC 204 Parasitology (1)** Introduction to medically important human parasites. Emphasis is on collection, preservation, and laboratory identification. *F; preq. MLTC 112; 1 lec. 2 lab*
- MLTC 207 Clinical Microbiology (5)** Diagnostic procedures for identification of medically important bacteria, viruses, and fungi. Emphasis is on the morphological, cultural, biochemical, and serological characteristics of various pathogenic bacteria, viruses, and fungi. *Su; coreq. BIOL 350; 3 lec. 6 lab; \$10.00*
- MLTC 209 Hematology 1 (4)** Basic laboratory methods in hematology, including cell counting, hemoglobinometry, and cell morphology. Detailed studies of blood cell maturation and development. *Sp; preq. BIOL 162 (or BIOL 310) and MLTC 112; 2 lec. 6 lab; \$10.00*
- MLTC 210 Hemostasis (2)** Study of hemostatic mechanism and hemorrhagic disorders as well as their laboratory evaluations. *Sp; preq. BIOL 162 (or BIOL 310) and MLTC 112; 2 lec. 2 lab; \$5.00*
- MLTC 211 Hematology 2 (3)** Continuation of MLTC 209 with emphasis on blood cell abnormalities, including anemias, leukemias, and special procedures in the study of blood diseases. *Su; preq. MLTC 209; 2 lec. 3 lab; \$5.00*
- MLTC 212 Clinical Chemistry 1 (4)** Principles, practices, and techniques of analyses of chemical components in serum, as well as other body fluids, are studied. Instrumentation associated with specific analyses is introduced. Emphasis on the specific chemical reactions and/or analytical principles, sources of error, quality control, practical applications, and theoretical aspects of the above procedures as related to normal and abnormal states. *Sp; preq. MLTC 112; 2 lec. 6 lab; \$10.00*
- MLTC 213 Clinical Chemistry 2 (3)** Continuation of MLTC 212. *F; preq. MLTC 212; 2 lec. 3 lab; \$10.00*
- MLTC 215 Lab Simulation (3)** A simulated laboratory environment is designed for students to participate in performing various tests in chemistry, hematology, urinalysis, blood banking, coagulation, and microbiology. Students are required to organize their work assignments, complete the assignments efficiently, and monitor quality control within established criteria. *W; preq. successful completion of all MLTC coursework below MLTC 215; 6 lab*
- MLTC 216 Medical Technology Seminar (1)** Issues and trends in Medical Laboratory Technology, government regulations, professional development, employment opportunities, resume writing, and job-seeking skills are discussed. *W; preq. successful completion of all MLTC coursework below MLTC 215*
- MLTC 217 Case Studies (1)** In conjunction with MLTC 215, students present case studies assigned in MLTC 215 to interpret and evaluate the clinical correlations and significance of the lab data. *W; preq. successful completion of all MLTC coursework below MLTC 215*

MLTC 201 - MLTC 217

MLTC 220 - MUSI 170

MLTC 220 Clinical Practicum 1 (4) Eighteen weeks of internship providing a practical application of the skill and knowledge learned during the previous quarters of the curriculum. Students are assigned to accredited hospital laboratories as trainees. The rotation schedule consists of three weeks in hematology-coagulation, four weeks in chemistry, four weeks in microbiology, four weeks in blood banking, one week in urinalysis, and one week of elective. *W; req. completion of all required MLTC courses with a minimum of "C" in the lab and lecture portion of each and a minimum GPA of 2.5*

MLTC 221 Clinical Practicum 2 (8) Continuation of MLTC 220. *Sp*

MLTC 225 Special Problems in Med Lab (2) Review of problems and progress during clinical practicum. Students are required to keep a daily log of the scope and degree of activities in the laboratory. The log book is filed with the department at the end of the clinical practicum. Students are also required to participate in laboratory inservice activities (and/or professional meetings if possible). Review exercises during the clinical rotation and a four-day Registry Exam review at the end of the internship are included. *Sp; req. MLTC 220*

MLTC 226 Special Topics in Med Lab (2) Individualized study of Medical Laboratory Technology in a selected area of interest: laboratory instrumentation, lab management, quality control, laboratory computer, hematology, clinical chemistry, immunology, immunohematology, microbiology, and histology. The selected topic must be approved by the faculty member and the clinical coordinator. The student is required to do library and/or laboratory studies, and a typewritten report on the topic is submitted to the department before the end of the clinical practicum. *Sp; req. MLTC 220*

Music

MUSI 100 Introduction to Music Theory (3) Developmental theory course used to make up deficiency. Introduction to staff, pitch, rhythmic notations, chords, ear training. *F*

MUSI 101 Music Theory 1 (3) Melodic, harmonic, and rhythmic principles of music and notation. *F; req. theory placement exam*

MUSI 102 Music Theory 2 (3) Continuation of MUSI 101. *W; req. MUSI 101*

MUSI 103 Music Theory 3 (3) Continuation of MUSI 102. *Sp; req. MUSI 102*

MUSI 120 Introduction to Music Literature (4) Development of listening skills for understanding elements of musical style in historical perspective and significance of music as a fine art. *F W Sp*

MUSI 121 Introduction to Baroque Music (3) Study of selected works from Baroque style periods through readings, tapes, recordings, and other media. *Offered on demand; req. MUSI 120 or permission; non-humanities majors*

MUSI 122 Introduction to Music of the Classical and Romantic Periods (3) Study of selected works from the Classical and Romantic style periods through readings, tapes, recordings, and other media. *Offered on demand; req. MUSI 120 or permission; non-humanities majors*

MUSI 123 Introduction to 20th Century Music (3) Study of selected works of 20th Century, both traditional and electronic, through readings, scores, tapes, recordings, and other media. *Offered on demand; req. MUSI 120 or permission; non-humanities majors*

MUSI 160 Fundamentals of Music (3) Principles of notation, meter, major, and minor scales, rhythmic and melodic reading, singing, and keyboard. *F W Sp*

MUSI 161 Music for the Classroom Teacher (3) Methods of teaching elementary music with emphasis on singing, playing instruments, and rhythmic body movements. *F W Sp; req. MUSI 160 and EDUC 110; \$25.00*

MUSI 170 Class Voice (1) Basic techniques of voice production: breathing, diction, projection, tone-color, and interpretation. Repeatable for credit—maximum of six quarters. *F W Sp; req. music reading. Must be taken in sequence or by permission of instructor.*

- MUSI 180 College Chorus (2)** Repeatable for credit—maximum of three quarters. *F; W Sp; preq. permission of instructor (audition); 4 lab; \$5.00*
- MUSI 181 College Band (2)** Repeatable for credit—maximum of three quarters. *F W; preq. permission of instructor (audition); 4 lab*
- MUSI 185 Vocal Ensemble (2)** Repeatable for credit—maximum of six quarters. *F W Sp; preq. permission of instructor (audition); 4 lab; \$5.00*
- MUSI 186 Instrumental Ensemble (2)** Repeatable for credit—maximum of six quarters. *F W; preq. permission of instructor (audition); 4 lab*
- MUSI 190 Class Piano 1 (1)** Study of scales and finger techniques for beginning players. *Su F W Sp; \$5.00*
- MUSI 191 Class Piano 2 (1)** Continuation of MUSI 190. *Su F W Sp; \$5.00*
- MUSI 192 Class Piano 3 (1)** Continuation of MUSI 191. *Su F W Sp; \$5.00*
- MUSI 220 Music Literature (4)** Survey of musical forms, styles, and performance media from Gregorian to present. Humanities majors. *F W Sp*
- MUSI 221 Music History and Literature 1 (3)** Study of literature and musical styles to 1600. *Offered on demand; preq. MUSI 220 or permission*
- MUSI 222 Music History and Literature 2 (3)** Study of literature and musical styles 1600-1850. *Offered on demand; preq. MUSI 221 or permission*
- MUSI 223 Music History and Literature 3 (3)** Study of literature and musical styles 1850 to present. *Offered on demand; preq. MUSI 222 or permission*
- MUSI 225 Country and Appalachian Music History 1 (4)** Understanding of the history of Appalachian music and the people, locations, and stories that underlie the music. Examines the evolution and influences of Appalachian music. *F*
- MUSI 226 Country and Appalachian Music History 2 (4)** Continuation and expansion of MUSI 225, including study of ballads, children's songs, dance, and musical families. *W*
- MUSI 227 Country and Appalachian Music History 3 (4)** Continuation and expansion of MUSI 226, including country and Appalachian music and musicians that have not yet been covered in MUSI 225 and 226. *Sp*
- MUSI 230 Music-Theater (3)** Participation through production or performance of selected musical theater projects. *Su Sp*
- MUSI 270 Intermediate Class Voice (1)** Continuation of MUSI 170 series. Repeatable for credit—maximum of six quarters. *F W Sp; preq. permission of instructor*
- MUSI 280 Intermediate Chorus (2)** Continuation of MUSI 180 series. Repeatable for credit—maximum of three quarters. *F W Sp; preq. permission of instructor; \$5.00*
- MUSI 299 Topics in Music (1-4)** Study of various music topics not otherwise available to students: folk and country, rock forum. Repeatable for credit—maximum of three quarters. *Offered on demand*
- MUSI 361 Teaching Music in Elementary Grades (3)** Materials and methods for teaching elementary vocal music. *Offered on demand; preq. MUSI 103*
- MUSI 370 Applied Voice (1)** Repeatable for credit—maximum of six quarters. *F W Sp; preq. music concentration; permission of instructor; \$5.00*
- MUSI 371 Applied Piano (1)** Repeatable for credit—maximum of six quarters. *Su F W Sp; preq. music concentration; permission of instructor; \$5.00*
- MUSI 372 Applied Organ (1)** Repeatable for credit—maximum of six quarters. *Su F W Sp; preq. music concentration; permission of instructor; \$10.00*

MUSI 180 - MUSI 372

MUSI 373 - OTAT 108

MUSI 373 Applied Woodwind (1) Repeatable for credit—maximum of six quarters. Offered on demand; *req. music concentration; permission of instructor; \$10.00*

MUSI 374 Applied Brass (1) Repeatable for credit—maximum of six quarters. Offered on demand; *req. music concentration; permission of instructor; \$10.00*

MUSI 390 Conducting (3) Conducting basic beat patterns; conducting techniques for choral groups; style and interpretation. Offered on demand; *req. music concentration or permission*

Natural Science

NTSC 110S Natural Science (4) Requirement for the General Education Program Option 1. Course addresses scientific reasoning and methodology. Credit not allowed for both NTSC 110S and PSCI 110S OR NTSC 110S and BIOL 110S. *Su F W Sp; \$10.00*

NTSC 240 Introduction to Environmental Science (4) Cross-listed as CHEM 240. Survey of the nature and scope of environmental problems. Emphasis on the physical, biological, and human aspects of environmental science. *F; req. sophomore standing with coursework in the basic sciences, BIOL 151, CHEM 143, or GEOL 201; 3 lec. 2 lab; \$22.00*

NTSC 311 Air Pollution (4) Cross-listed as GEOG 311. Examination of air pollutants and their social and economic impacts, control strategies, and air pollution planning. *Su alternate years, W*

NTSC 433 Methods of Teaching Science in the Secondary School (4) Cross-listed as EDUC 433. Use of a variety of instructional strategies, science curricula, evaluation techniques, and community resources are examined. Establishing and maintaining safety in the classroom, field, and storage areas are emphasized. The use and care for living organisms in an ethical and appropriate manner are experienced. Students participate in the planning and implementation of science experiences for students in the field and clinical setting. *Preq. BIOL 151, CHEM 141, GEOL 111, PSCI 251, EDUC 310; coreq. EDUC 410; 2 lec. 1 lab/clinical 6 field; \$40.00*

NTSC 490S Senior Seminar (4) Provides an opportunity for students to place their chosen field of study in an interdisciplinary context with intellectual, ethical, and historical perspectives. The seminar focuses on the synthesis and integration of various concepts by applying them to the analysis and solution of problems chosen in the context of their academic disciplines. Oral and written presentations of the seminar paper are required. *Su F W Sp; req. senior standing and 44 general education program hours*

Occupational Therapy Assistant

OTAT 101 Introduction to Occupational Therapy (4) Cross-listed as OTST 101. Introduction to the profession of occupational therapy, the roles and functions of occupational therapy personnel, the areas of occupational performance, and the theoretical basis of using goal-directed activities. *W; req. enrollment in OTA program—professional phase*

OTAT 102 Therapeutic Media 1 (3) Introduction to the analysis and therapeutic application of activities. Includes skill development in selected activities, instruction of peers in an activity, and participation in proper care and maintenance of equipment and supplies. *W; req. enrollment in OTA program*

OTAT 103 Disease Pathology 1 (4) Cross-listed as OTST 103. Discussion of both physical and psychosocial dysfunctions commonly referred to occupational therapy. Includes the symptoms, etiology, and treatments of various diseases. *Sp; req. OTAT 101/OTST 101, BIOL 101, and AHNR 102*

OTAT 108 Practicum 1 (2) Supervised clinical experience under the direction of qualified personnel in a variety of settings. Emphasis is on developing professional communication skills, learning to accurately document observations, developing an understanding of other health care professionals, and instructing a small group in an activity. See academic requirements of OTA program. *W; req. enrollment in OTA program*

- OTAT 109 Applied Anatomy and Kinesiology (2)** Study and application of human anatomy and basic movement principles as used in occupational therapy. *Sp; preq. OTAT 101*
- OTAT 110 Group Dynamics (2)** Cross-listed as OTST 110. Study of group behavior. Practice in leading groups, observing group interactions, and participating in various types of groups. *Sp; preq. OTAT 101/OTST 101, PSYC 101, and SOCI 101*
- OTAT 203 Occupational Therapy Assistant in Developmental Disabilities (5)** Study of conditions which interfere with normal growth and development. Introduction to the application of occupational therapy in the treatment of developmental disabilities. Emphasis on the role of the O.T. assistant in treatment of developmental disabilities particularly in the public school setting. *F; preq. OTAT 108, 109, 110, PSYC 101, and 151; \$5.00*
- OTAT 204 Practicum 2 (3)** Similar to OTAT 108 but in different types of settings. *Su; preq. OTAT 108, 109, and 110*
- OTAT 205 Therapeutic Media 2 (3)** Cross-listed as OTST 205. Analysis, adaptation, and therapeutic application of activities not covered in OTAT 102. *Su; preq. OTAT 101/OTST 101*
- OTAT 206 Contemporary Media in Occupational Therapy (2)** Cross-listed as OTST 206. Analysis, adaptation, and therapeutic applications of "high-tech" media. Emphasis on computer adaptations, construction of switches, and use of video in patient treatment. *F; preq. Completion of or concurrent with OTAT 205*
- OTAT 208 Practicum 3 (3)** Supervised clinical experience under the direction of qualified personnel in a variety of settings. Continuation of skill development of OTAT 204 with additional emphasis on case study, treatment planning, and occupational therapy treatment techniques. *F; preq. OTAT 204*
- OTAT 209 Occupational Therapy Assistant in Geriatric Program Planning (4)** Introduction to and application of occupational therapy in the treatment of older adults. Emphasis is on developing and implementing both activity and rehabilitative programs in agencies serving the elderly. *W; preq. OTAT 210; \$5.00*
- OTAT 210 Occupational Therapy Assistant in Physical Dysfunction (5)** Exploration of occupational therapy theories in the evaluation and treatment of physically disabling conditions. Lab emphasis on instruction of activities of daily living, work simplification, energy conservation, and fabrication of orthotic and adaptive devices. *Su; preq. OTAT 109; \$30.00*
- OTAT 211 OTA Seminar (2)** Discussion of the professional roles and responsibilities of the occupational therapy assistant. Includes orientation to licensure, certification, legal and ethical issues, peer review, and other current professional issues. *W; preq. OTAT 208 and 210*
- OTAT 212 Occupational Therapy Assistant in Mental Health (4)** Exploration of occupational therapy theories in the evaluation and treatment of psychosocial dysfunction. Lab emphasis on the development of observation skills, group dynamics, group leadership, effective communication, and therapeutic use of self. *W; preq. OTAT 208, 210, PSYC 101, 151, and SOCI 101*
- OTAT 220-221 Clinical Application (8 ea.)** Supervised fieldwork placement. Experience in and responsibility for delivery of service to patients/clients. Emphasizes the application of academically acquired knowledge leading to the performance of an entry-level occupational therapy assistant. See academic and clinical requirements of OTA program. *Sp; preq. successful completion of all OTA and other required courses*
- OTAT 299 Special Topics in OT (1-3)** Provides students an opportunity to gain additional knowledge or experience in a specific area of occupational therapy. *Su F W Sp; preq. admission to OT/OTA program and permission of instructor*

OTAT 109 - OTAT 299

OTST 101 - OTST 416

Occupational Therapy

- OTST 101 Introduction to Occupational Therapy (4)** Cross-listed as OTAT 101. Introduction to the profession of occupational therapy, the roles and functions of occupational therapy personnel, the areas of occupational performance, and the theoretical basis of using goal-directed activities. *W; req. enrollment in OT program-professional phase.*
- OTST 103 Disease Pathology 1 (4)** Cross-listed as OTAT 103. Discussion of both physical and psychosocial dysfunctions commonly referred to occupational therapy. Includes the symptoms, etiology, and treatments of various diseases. *Sp; req. OTST 101; BIOL 101 or 151, and AHRN 102*
- OTST 110 Group Dynamics (2)** Cross-listed as OTAT 110. Study of group behavior. Practice in leading groups, observing group interactions, and participating in various types of groups. *Sp; req. OTST 103, PSYC 101, and SOCI 101*
- OTST 205 Therapeutic Media 2 (3)** Cross-listed as OTAT 205. Analysis, adaptation, and therapeutic application of activities. *Su F; req. OTST 101*
- OTST 206 Contemporary Media in Occupational Therapy (2)** Cross-listed as OTAT 206. Analysis, adaptation, and therapeutic applications of "high-tech" media. Emphasis on computer adaptations, construction of switches, and use of video in patient treatment. *F; req. completion of or concurrent with OTST 205*
- OTST 305 Disease Pathology 2 (4)** The etiology, clinical course, management, and prognosis of congenital, developmental, acute, and chronic disease processes and traumatic injuries. The effect of such conditions on human functioning throughout the life span. Focus is on neuromuscular, musculoskeletal, and neurological systems. *F; req. admission to OT program or OTAT 103*
- OTST 310 Practicum 1 for OTS (2)** Level 1 Fieldwork. The first competency based fieldwork course to develop professional skills in health service delivery. Students gain an appreciation of the role of occupational therapy in health care. Students are assigned to a variety of agencies serving health care needs. *Sp; req. admission to OT program and OTST 101*
- OTST 330 Orthotics (3)** Includes theoretical basis and application of orthotics to enhance independent daily living performance in work, play/leisure, and self care. Designing, fabricating, and using orthotic devices. *W; req. admission to OT program and OTST 206*
- OTST 410 OT in Physical Disabilities 1 (4)** Theories, approaches, and principles of occupational therapy programming for physical function throughout the life span. Includes theoretical basis, assessment, and treatment to foster age-appropriate skills in daily living activities, work, and play/leisure. Emphasis is on theory and assessment. *W; req. OTST 305, BIOL 311, and PHYS 201*
- OTST 411 OT in Physical Disabilities 2 (4)** Continuation of theory application covered in OTST 410, with emphasis on treatment planning, adaptations, prevention, health maintenance, and remediation. *Sp; req. OTST 410 and BIOL 314*
- OTST 412 OT in Mental Health 1 (4)** Theories, approaches, and principles of occupational therapy programming for mental health services throughout the life span. Includes theoretical basis, assessment, and treatment to foster age-appropriate skills in daily living activities, work, and play/leisure. Emphasis is on theory and assessment. *W; req. OTST 305 and PSYC 400*
- OTST 413 OT in Mental Health 2 (4)** Continuation of theory application covered in OTST 412, with emphasis on treatment planning, adaptation, prevention, health maintenance, and remediation. *Sp; req. OTST 412 and BIOL 314*
- OTST 416 OT in Gerontology (4)** Theories, approaches, and principles of gerontic occupational therapy. Theories of aging, normal physiological and psychological changes of aging, specific diseases and conditions, and common problems of the aging population. Includes quality assurance, consultative role of the OTR in nursing homes, and legal issues regarding aging. *Sp; req. OTST 410 and 412 and BIOL 314*

OTST 420 Practicum 2 for OTS (2) Level 1 Fieldwork. The second competency based fieldwork to develop professional skills in occupational therapy service delivery. Focus on observation, evaluation, and documentation of client abilities. Students are assigned to agencies different from those in OTST 310. *Sp; req. OTST 410 and 412*

OTST 421 Practicum 3 for OTS (2) Level 1 Fieldwork. The third competency based fieldwork to develop professional skills in occupational therapy service delivery. Focus on treatment planning and implementation. Students are assigned to agencies different from those in OTST 310 and OTST 420. *Su; req. OTST 411, 413, and 420*

OTST 430 OT in Developmental Disabilities 1 (5) Theories, approaches, and principles of occupational therapy programming for issues related to normal and abnormal patterns of human development. Evaluation, program planning, and treatment application as it pertains to individuals and their families. *Su; req. OTST 411 and 413, BIOL 314, and PSYC 151*

OTST 431 OT in Developmental Disabilities 2 (4) Continuation of material covered in OTST 430, with emphasis on neurodevelopmental and sensory integration theory and treatment. *F; req. OTST 430*

OTST 450 Research Designs and Methods in OT (4) Students learn to be consumers of research data, conduct literature searches, examine methods of research design and data collection, and prepare a research proposal related to occupational therapy. *Su; req. OTST 411, 413, 416, 430, and MATH 150*

OTST 451 Occupational Therapy Management and Program Planning (4) Occupational therapy service management skills. Includes health care trends, quality assurance, and legal issues. Students develop a model for the delivery of occupational therapy services in a selected agency or facility. *F; req. OTST 430 and BUAI 101 or BUIS 101*

OTST 495 Clinical Application 1 (12) Level 2 Fieldwork. Three months of supervised, in-depth field experience in a selected practice area of occupational therapy. Student is supervised by a Registered Occupational Therapist. *W; req. successful completion of all required courses in OT curriculum.*

OTST 496 Clinical Application 2 (12) Level 2 Fieldwork. Three months of supervised, in-depth field experience in a practice area different from OTST 495. Student is supervised by a Registered Occupational Therapist. *Sp; req. OTST 495*

OTST 497 Clinical Application 3 (Optional) (4, 8, or 12) Level 2 Fieldwork. One to three months of supervised, in-depth field experience in a specialty practice area of occupational therapy. Student is supervised by a Registered Occupational Therapist. *Su; req. OTST 496*

Philosophy

PHIL 100 Introduction to Philosophy (4) An introduction to some of the central philosophical issues within the Western tradition, from ancient Greece to the present, through the use of selected primary texts. *F 1997 and 1998*

PHIL 103 Introduction to Ethics (4) Classic and modern philosophical views of the nature of morality. Recognizing the moral dimension of a choice and reasoning about alternatives.

PHIL 105 Rhetoric and Reasoning (4) An introductory course in deductive and inductive reasoning, with particular emphasis upon the analysis, evaluation, and construction of arguments. This course also examines the use of rhetoric in argumentation, especially in advertising, politics, and public speaking. *F 1997, W 1998*

PHIL 170 Introduction to Formal Logic (4) Deductive and inductive reasoning; translation from natural to formal language; sentential logic, Aristotelian logic, predicate logic; logic and computers.

PHIL 280 The Judeo-Christian Tradition (4) How our culture is informed by this tradition. Application to selected contemporary issues. *Offered on demand*

OTST 420 - PHIL 280

PHIL 282 - PHYS 099

- PHIL 282 Old Testament (4)** Reading and interpretation of selected portions of the Old Testament. Literary, historical, theological, and philosophical interpretations; relation to the New Testament. *W*
- PHIL 283 New Testament (4)** Reading and interpretation of selected portions of the New Testament. Literary, historical, theological, and philosophical interpretations; relation to the Old Testament. *Sp*
- PHIL 284 Oriental Philosophy (4)** A survey of Oriental philosophical traditions including Hinduism, Buddhism, Confucianism, and Taoism. The relationship between Taosim and Native American world views is examined. *W 1999*
- PHIL 299 Special Topics in Philosophy (1-6)** Individual or small-group study of topics not otherwise available. May be repeated for credit with permission of the instructor. *Offered on demand*
- PHIL 300 Philosophy of Film (4)** Viewing and discussion of international films and their philosophical, aesthetic, and moral dimensions. Includes films by Godard, Kurosawa, Rohmer, Bergmann, Fellini, Yimou. *S 1998*
- PHIL 316 Existentialism (4)** The unique individual vs. the crowd; total freedom and unlimited responsibility; creating the self vs. bad faith; the solitary individual before God or the superman who can face the death of God. Primary readings from Kierkegaard and Nietzsche.
- PHIL 320S Ethics in Public and Private Life (4)** Exploration of the major currents in Western ethical thought, with application to contemporary ethical controversies. Special emphasis is placed upon entering into rational dialogue with moral views other than one's own. *F W Sp*
- PHIL 331 Business Ethics (4)** Cross-listed as BUMG 331. Examination of the relationship between economic and moral constraints. *Su F W Sp; preq. ENGL 115S*
- PHIL 332 Biomedical Ethics (4)** Ethical issues in medicine, medical research, and biotechnology; relations within the health team, informed consent; wellness and illness; right to health care; moral implications of bioengineering. *Sp 1998 and 1999*
- PHIL 333 Philosophy and Technology (4)** The role played by technology in human history. The social and political implications of contemporary information processing, genetic engineering, surveillance, and military technology. Rights and responsibilities of technological experts, especially in engineering and the health sciences. *F 1998*
- PHIL 334 Environmental Ethics (4)** Theories of the environment; alternative views of our responsibility for the environment, including deep ecology; environmental vs. economic values; methods of resolving environmental issues. *Sp 1999*
- PHIL 335 Philosophy and Education (4)** Theories of teaching and learning from ancient Greece to the contemporary classroom.
- PHIL 430 Capitalism, Socialism, and Democracy (4)** An examination of theories of society and the state that have significantly influenced Western thought from Ancient Greece to the present. Special emphasis is given to the current controversy between communitarianism and classical liberalism as paradigms for resolving social, political, and economic issues. *Sp 1999*
- PHIL 499 Special Topics in Philosophy (1-5)** A seminar in selected topics in philosophy. Course content varies from year to year. May be repeated for credit. *Offered on demand*

Physics

- PHYS 099 Fundamental Physics (4)** A course intended for special programs and not considered a prerequisite for the college entry-level physics courses. Students desiring a basic course in physics should refer to PHYS 201. *Offered on demand.*

PHYS 201 - PSCI 251

- PHYS 201 Physics 1 (Mechanics) (4)** Newton's Laws of Motion. Other appropriate topics may be included. Laboratory and demonstrations related to lecture. *F W; preq. MATH 130 or equivalent; 6 hrs., lecture & lab; \$10.00*
- PHYS 202 Physics 2 (Electricity and Magnetism) (4)** Basic properties of electric and magnetic fields. Other appropriate topics may be included. Laboratory and demonstrations related to lecture. *Sp; preq. PHYS 201; 6 hrs., lecture & lab; \$10.00*
- PHYS 203 Physics 3 (Energy) (4)** First and second laws of thermodynamics. Other appropriate topics may be included. Laboratory and demonstrations related to lecture. *W Sp; preq. PHYS 201; 6 hrs., lecture & lab; \$10.00*
- PHYS 210 Astronomy (4)** Fundamental ideas of astronomy. Topics include the solar system, stars, galaxies, black holes, and the history of ideas about the universe. *3 lec. 3 lab*
- PHYS 211 Calculus-Based Physics 1 (4)** Introductory survey of mechanics for science and engineering students. Introduces the use of calculus in interpreting physical phenomena. Topics include vectors, kinematics, and Newton's theory of motion. *Preq. or coreq. MATH 201; 6 hrs., lecture & lab; \$10.00*
- PHYS 212 Calculus-Based Physics 2 (4)** Introductory survey of thermodynamics for science and engineering students. Introduces the use of calculus in interpreting physical phenomena. Topics include the first and second laws of thermodynamics. *Preq. PHYS 211 or instructor permission; preq. or coreq. MATH 202; 6 hrs., lecture & lab; \$10.00*
- PHYS 213 Calculus-Based Physics 3 (4)** Introductory survey of electricity and magnetism for science and engineering students. Introduces the use of calculus in interpreting physical phenomena. Topics include some of Maxwell's equations. *Preq. MATH 202 and PHYS 212 or instructor permission; 6 hrs., lecture & lab; \$10.00*
- PHYS 290 Seminar in Physics (1-4)** Discussion of advanced topics in physics.
- PHYS 295 Independent Study (1-4)** Independent physics investigation under the direction of a faculty member.
- PHYS 299 Special Topics in Physics (1-4)** Individual or small-group study, under the supervision of instructor, of topics not otherwise available to students.
- PHYS 390 Seminar in Physics (1-4)** Discussion of advanced topics in physics.
- PHYS 485 Senior Project (1-4)** In-depth study of a selected topic in physics culminating in the preparation of a senior paper. *Preq. junior or senior standing*
- PHYS 490 Seminar in Physics (1-4)** Discussion of advanced topics in physics. *Preq. junior or senior standing*
- PHYS 495 Undergraduate Research (1-4)** Independent physics investigation under the direction of a faculty member. *Preq. junior or senior standing*
- PHYS 499 Special Topics in Physics (1-4)** Individual or small-group study, under the supervision of instructor, of topics not otherwise available to students. *Preq. junior or senior standing*

Physical Science

- PSCI 251 Physical Science by Inquiry 1 (4)** An inquiry-based (lab-oriented) course in the physical sciences designed primarily for those students who expect to teach the physical sciences (K-12) or those who learn better with a hands-on approach to science. Topics include properties of matter (mass, volume, density, concentration, and solubility) and heat and temperature (calorimetry, phase change, and heat transfer). *6 lab; \$10.00*
- PSCI 252 Physical Science by Inquiry 2 (4)** A continuation of PSCI 251. Topics include electric circuits (current, voltage, power, energy, d.c. circuits) and light and optics (refraction, reflection, image formation, and color). *6 lab; \$10.00*

PSCI 295 - PSYC 310

PSCI 295 Independent Study (1-4) Independent physical science investigation under the direction of a faculty member.

PSCI 299 Topics in Physical Science (1-4) Individual or small-group study, under the supervision of instructor, of topics not otherwise available to students.

Psychology

PSYC 098 Learning Orientation (4) Techniques for learning definitions, vocabulary, lists, etc. to assist in academic achievement. (The four hours of credit do not apply toward a degree but do apply toward total hours accumulated at the University.)

PSYC 101 Introduction to Psychology (4) A study of the individual in terms of maturational, learning, thinking, emotional, motivational, sensory, and perceptual processes. Required course for all social science majors. *Su F W Sp*

PSYC 105 Career Planning (4) This course helps students explore their values, interests, and skills in relation to careers and choosing a college major. Special emphasis on career counseling. Career exploration on the computer is available. *Su F W Sp*

PSYC 150 Principles of Statistics (4) Cross-listed as MATH 150 and SOCI 150. Introduction to the vocabulary, concepts, formulas, and presentation of statistics as applied to business, education, and science. Topics include measures of central tendency and dispersion, probability applied to joint probability tables and Bayes' Theorem, probability distributions with emphasis on Binomial and Normal, sampling practices and theory, and calculator and computer use. *F W Sp; req. MATH 101*

PSYC 151 Human Growth and Development (4) Study of the factors affecting human growth and development through the life cycle from infancy to advanced maturity. *F W Sp; req. PSYC 101*

PSYC 199 Special Topics in Psychology (1-4) Individual or small-group study, under the supervision of instructor, of topics not otherwise available to students. Separate courses repeatable for credit.

PSYC 273 Psychology of Human Adjustment (4) An examination of the individual's adjustments and conflicts in modern society. Considers problem-solving strategies and anxiety reducing behavior. Required course for all social science majors. *Su F W Sp; req. PSYC 101*

PSYC 290 Psychological Tests and Measurements (4) Study of the nature, construction, and use of tests and measurements in education, industry, and government, including aptitude, ability, and achievement tests; attitude and rating scales; and opinion surveys. *Offered as demand indicates; req. PSYC 101*

PSYC 299 Special Topics in Psychology (1-4) Courses repeatable for credit. *Req. PSYC 101 and/or permission*

PSYC 300 Theories of Personality (4) Understanding of human personality through examination of psychoanalytic, humanistic, and learning theories and current biologically-based research on personality. *W; req. PSYC 101*

PSYC 303 Introduction to Social Psychology (4) Cross-listed as SOCI 303. Behavior of the individual as influenced by other individuals, social groups, and culture. Examines group dynamics, leadership, attitude, and group conflict. *Offered as demand indicates; req. PSYC 101*

PSYC 304 Psychology of Learning (4) Study of learning: classical and instrumental conditioning, discrimination, generalization, verbal, information processing, memory, problem solving, and concept formation. *F; req. PSYC 101*

PSYC 310 Child Psychology (4) A survey of the course of development during the first 12 years of life, with emphasis on patterns of physical, cognitive, and mental development; parent/child relations; and the influences of TV and divorce on children. *F W; req. PSYC 101*

PSYC 311 - PSYC 420

PSYC 311 Human Sexuality (4) Cross-listed as SOCI 311. An in-depth view of the current status of human sexuality in the U.S. Examines current research; modes of sexual expression and enhancement; physiological, sociological, and psychological basis of human sexuality; sexual variations; and sex ethics. *F*

PSYC 312 Adolescent Psychology (4) Study of major theories of adolescent development and explanation of biological, cognitive, social, emotional, and personality processes. Focus is on recent trends and changes in family relationships, adolescent autonomy, educational and vocational roles, moral development and religion, teenage creativity, depression, substance abuse, eating disorders, runaways, suicide, pregnancy, and parenthood. *Sp; preq. PSYC 101*

PSYC 316 Behavior Problems in Children (4) Analysis of personal and school-related problems of children. Cases of behavior problems with specific intervention techniques. *Sp; preq. PSYC 101*

PSYC 340 Psychology of the Adult (4) Theoretical study of adulthood with an emphasis on the applications of psychological research for a better understanding of later life. Class presentations and discussions cover age-related changes in physical, cognitive, social, and personality development and address issues in adult psychopathology, death, and dying. *Offered as demand indicates; preq. PSYC 101*

PSYC 360 Drugs/Substance Abuse (4) Cross-listed as BUHE 360, HPER 360, and SOCI 360. An in-depth study of alcohol, tobacco, and other drugs and how chemical dependency on these drugs can affect individual performance and behavior. *F W Sp*

PSYC 361 Industrial Psychology (4) Applies social/psychological approach to individual's work behavior. Topics include management approaches to organizational processes resulting in productivity and satisfaction, change, turbulent environment, and psychologist's role. *Offered as demand indicates; preq. PSYC 101 or SOCI 101*

PSYC 375 Educational Psychology (4) Psychological foundations of education with emphasis on learning, transfer, motivation, and evaluation. *F W Sp; preq. PSYC 101*

PSYC 380 Psychology of Exceptional Children and Youth (4) Psychological study of exceptionality, including the physically, socially, and emotionally handicapped, and the intellectually handicapped and gifted. The psychological characteristics of the exceptional children and youth are investigated, and current programs used to help them are identified and evaluated. *Offered as demand indicates; preq. 12 credit hours of PSYC and/or instructor permission*

PSYC 399 Special Topics in Psychology (1-4) Individual or small-group study, under the supervision of instructor, of topics not otherwise available to students.

PSYC 400 Abnormal Psychology (4) Study of anxiety, mood, psychotic, personality, and psychoactive substance use disorders as well as substance-induced organic mental disorders. Several theories and strategies of psychotherapy are examined during discussion of each disorder. *F W Sp; preq. at least 12 credit hours of PSYC*

PSYC 405 Death and Dying (4) Cross-listed as SOCI 405. Focus on increased ability to deal with one's own mortality; skills for working with terminally ill and their families; understanding the complex social system of death in American society; and moral, ethical, and philosophical issues surrounding death. *F; preq. PSYC 101 or SOCI 101*

PSYC 410 Psychology of Counseling (4) Survey of the basic concepts and theories of counseling: psychodynamic, behavioral, cognitive, and humanistic. Focus is on individual and group counseling, including school, career, family and marriage, mental health, cross-cultural, crisis intervention, and consultation. *Sp; preq. 20 credit hours of PSYC and/or instructor permission*

PSYC 420 Community Psychology (4) Analysis of historical precedents, epidemiology, community resources, primary prevention programs, and the role of psychologists as agents of social change. *Offered as demand indicates; preq. PSYC 101*

PSYC 440 - PTAT 231

PSYC 440 Environmental Psychology (4) Psychological investigation of the relationship between individual behavior and physical environment with analysis of the impact of crowding, noise, temperature, lighting, pollution, and architecture on individual behavior. *Offered as demand indicates; req. 16 credit hours of PSYC and/or instructor permission*

PSYC 475 Psychological Study of Contemporary Problems (4) In-depth analysis of current issues, problems, and controversies in psychology. *Offered as demand indicates; req. 24 credit hours of PSYC (senior students in psychology)*

PSYC 499 Special Topics in Psychology (1-4) Individual or small-group study, under the supervision of instructor, of topics not otherwise available to students. *Req. senior standing and permission*

Physical Therapist Assistant

PTAT 111 Principles of Physical Therapist Assistant (3) The purpose, philosophy, history, and development of the physical therapy profession. Includes medical ethics, the function of the American Physical Therapy Association, and the development of the physical therapist assistant (duties, function, legal responsibilities, and limitations). *Req. admission to PTA program*

PTAT 112 Physical Therapist Assistant Procedures 1 (5) The first of three sequential procedure courses. Basic physiology and theory of heat, hydrotherapy, cold, massage, body mechanics, burns, patient positioning, and traction. Therapeutic application of these modalities. *W; req. AHN 102 and PTAT 111; 3 lec. 6 lab*

PTAT 113 Physical Therapist Assistant Procedures 2 (5) Theory and therapeutic application of modalities, such as low and high frequency currents, biofeedback, TENS, Jobst extremity pump, and diathermy. *Sp; req. PTAT 112; 3 lec. 6 lab*

PTAT 114 Anatomy and Kinesiology (5) Advanced anatomy course designed specifically for the physical therapist assistant. Origin, insertion, function, and dysfunction. *Su; req. PTAT 113 and BIOL 311; 3 lec. 6 lab*

PTAT 115 P.T. in Physical Dysfunction (3) Discussion of physical dysfunctions commonly referred to physical therapy. Includes symptoms, etiology, and treatments of various diseases. *W; req. PTAT 111; 3 lec.*

PTAT 116 Neurology for PTA (1) Introduction to the central and peripheral nervous system as it relates to physical therapy. *Sp; req. PTAT 115; 1 lec.*

PTAT 202 Physical Therapist Assistant Procedures 3 (5) Theory and application of principles of muscle testing and goniometry. Includes study and use of rehabilitation skills relating to prosthetics, orthotics, postural deviations, cardiac conditions, and pre and post partum condition. *F; req. PTAT 113; 3 lec. 6 lab*

PTAT 212 Clinical Practicum 1 (4) Second experience in clinical setting in which the student performs theories and techniques for patient care under close supervision of a licensed physical therapist. *F; req. PTAT 114, 115, and 216; 2 lec. 12 clinical*

PTAT 213 Clinical Practicum 2 (4) Intermediate experience in clinical settings performing previously learned theories and techniques under supervision of a licensed physical therapist. *W; req. PTAT 202, 212, and 231; 2 lec. 12 clinical*

PTAT 214 Clinical Practicum 3 (6) Advanced experience in clinical setting. *Sp; req. PTAT 213, 232, and 255; 38 clinical*

PTAT 216 Clinical Practicum Seminar (2) Introductory experience in clinical setting. Students perform theories and techniques of patient care under close supervision of licensed physical therapist. Procedures and techniques discussed in seminar. *Su; req. PTAT 111 and 112; 1 lec. 4 clinical*

PTAT 231 Rehabilitation Procedures 1 (4) The first of two sequential, therapeutic, exercise classes. Exercises for specific joints and orthopedic conditions. Includes joint range of motion, flexibility, coordination, and gait training. *F; req. PTAT 113; 3 lec. 3 lab*

PTAT 232 Rehabilitation Procedures 2 (4) Rehabilitation skills needed for treatment of central nervous, peripheral nervous, and respiratory systems. Included are stroke rehabilitation, spinal cord injuries, pediatrics, and postural drainage. *W; preq. PTAT 231; 3 lec. 3 lab*

PTAT 235 Physical Therapy Trends and Administrative Procedures (2) Identification of concepts, techniques, and administrative skills used in the efficient operation of physical therapy department. Special emphasis on establishing and maintaining patient records. *F; preq. PTAT 212*

PTAT 255 PTA Seminar (2) Students present case studies of patients treated in their clinical assignments. Special procedures, techniques, and problems encountered are discussed. *Sp; coreq. PTAT 214*

Radiologic Technology

RDLT 101 Radiologic Technology 1 (4) A course designed to acquaint the student with the goals, philosophies, and organizations of the radiography program and the radiology department. Medical ethics, medicolegal considerations, elementary radiation protection, fundamentals of radiographic exposure, and radiographic positioning of the chest and abdomen are covered. *F; preq. admission to radiologic technology program; \$14.00*

RDLT 102 Radiologic Technology 2 (4) Concentration on radiographic positioning of the appendicular skeleton with application of theory in the laboratory. Selected clinical experiences reinforce learning and provide the opportunity to apply principles and techniques. *W; preq. RDLT 101; \$5.00*

RDLT 103 Radiologic Technology 3 (3) Concentration on radiographic positioning of the axial skeleton with application of theory in the laboratory. *Sp; preq. RDLT 102; \$5.00*

RDLT 104 Radiologic Technology 4 (3) Concentration on radiographic procedures using contrast media, radiographic practices for surgery, pediatric radiography, and other specialized areas of radiography. *Su; preq. RDLT 103 and 111*

RDLT 105 Radiologic Technology 5 (3) Continuation of RDLT 104 with emphasis on vascular and neurological examination, including analysis of equipment used. *F; preq. RDLT 104; \$14.00*

RDLT 106 Radiologic Technology 6 (3) Examination of advanced radiographic techniques and imaging modalities, quality control, fluoroscopy, image intensifiers, conventional tomography, stereo radiography, xeroradiography, computed tomography, magnetic resonance imaging, ultrasound, and other specialized areas of imaging. *W; preq. RDLT 105*

RDLT 107 Radiologic Technology 7 (3) A series of lectures on pathologic conditions and their impact on the radiographic process. Includes student participation in film evaluation and case studies. *Sp; preq. RDLT 106*

RDLT 108 Radiologic Technology 8 (2) Designed as a self assessment of the independent cognitive areas utilized in the clinical situation. *Su; preq. RDLT 107 and 113*

RDLT 111 Radiologic Physics (4) A study of the fundamentals of matter, electrostatics, electrodynamics, magnetism, rectification, production, and properties of x-rays, x-ray tubes, and x-ray circuitry. *Sp; preq. MATH 130 and RDLT 102 and 200; \$5.00*

RDLT 112 Radiobiology and Radiation Protection (3) Lectures on the radiobiological areas of radiation interactions, radiosensitivity, radiation dose/response relationships, early and late radiation effects, radiation protection, and health physics. *W; preq. RDLT 201*

RDLT 113 Radiographic Processing (2) Includes discussions of film characteristics, artifacts, film storage and handling, processing room design and function, methods, principles and chemistry of processing systems, silver reclamation, and quality control. *Sp; preq. RDLT 112 and 201*

PTAT 232 - RDLT 113

RDLT 200 - RPTT 115

RDLT 200 Patient Care (3) Provides knowledge and basic skills necessary for care of the patient. Includes medical and professional ethics, medical terminology, and interpersonal relationships. *W; preq. RDLT 101*

RDLT 201 Radiographic Exposure (4) Lectures on establishing and manipulating radiographic exposure factors and on the proper utilization of accessory devices such as grids, intensifying screens, and beam limitation devices. Concentration is on overall image quality, as well as factors affecting patient exposure. *F; preq. RDLT 104; \$10.00*

RDLT 211 Clinical Experience 1 (2) Practical application of radiologic technology principles, positioning, and techniques with emphasis on upper and lower extremity examinations in the radiology departments of affiliate hospitals. Includes film critique sessions. *Sp; preq. RDLT 102*

RDLT 212 Clinical Experience 2 (3) Continuation of RDLT 211 with emphasis on spine and skull examinations. *Su; preq. RDLT 211*

RDLT 213 Clinical Experience 3 (3) Continuation of RDLT 212 with emphasis on urographic, biliary, and gastrointestinal examinations. *F; preq. RDLT 212*

RDLT 214 Clinical Experience 4 (3) Continuation of RDLT 213 with emphasis on gastrointestinal, portable, and advanced bonework examinations. *W; preq. RDLT 213*

RDLT 215 Clinical Experience 5 (3) Continuation of RDLT 214 with emphasis on headwork, surgery, and advanced radiographic examinations. *Sp; preq. RDLT 214*

RDLT 216 Clinical Experience 6 (4) Continuation of RDLT 215 with emphasis on advanced imaging modalities. *Su; preq. RDLT 215*

RDLT 312 Sectional Anatomy (3) This lab-oriented course is designed to introduce students to human anatomy displayed in sections. Emphasis is on anatomical structures visualized in computed tomography, magnetic resonance imaging, and ultrasonography. *Sp; preq. BIOL 162, 310, or instructor permission; 2 lec. 2 lab*

Reflections on Community Involvement

ROCI 485S Reflections on Community Involvement (4) An outgrowth of the purposes and objectives of the University. The series of activities integral to the community involvement course enhances the education of the student, complements the senior seminar, and promotes reflection on the student's obligation to human beings in need and society at large. (not offered summer quarter)

Respiratory Therapy

RPTT 101 Basic Patient Care (3) Introduction to respiratory therapy as a profession and to basic clinical assessment and care of patients. Professional duties and responsibilities, ethics and liability, and basic patient care skills (patient assessment, record keeping, patient monitoring, pulmonary care techniques) are included. *W; preq. RPTT 102; 2 lec. 3 lab; \$9.00*

RPTT 102 Cardiopulmonary/Renal Anatomy and Physiology (5) Detailed presentation of the anatomy and physiology of the pulmonary, cardiac, and renal systems. Topics include basic structure and function, system interactions, and basic pathophysiology with emphasis on the pulmonary system. *F; preq. admission to respiratory therapy program*

RPTT 110 Medical Gas Therapy (4) Presentation of topics related to the production, handling, and administration of medical gases, including humidity and aerosol therapy, medical gas therapy, equipment required for their administration, and the indications, contraindications, and hazards of their use. *W; preq. RPTT 102; 3 lec. 3 lab; \$10.00*

RPTT 115 Clinical Application 1 (1) Introduction to the clinical setting, orientation to the hospital, and an opportunity to practice those skills and techniques learned in RPTT 101 and 110. *W; preq. RPTT 102; 8 clinical*

RPTT 120 - RPTT 212

- RPTT 120 Perioperative Care (4)** Detailed discussion of respiratory therapy techniques used before and after surgery to minimize complications. Topics include respiratory pharmacology, incentive spirometry, bronchopulmonary drainage, and intermittent positive pressure breathing. *Sp; preq. RPTT 101, 110, and 115; 3 lec. 3 lab; \$5.00*
- RPTT 121 Airway Management (2)** A study of artificial airways, airway obstruction, and defense mechanisms of the lungs. Topics include design, selection, and insertion of artificial airways as well as protective mechanisms of the lungs. *Sp; preq. RPTT 101, 110, and 115; 1 lec. 3 lab*
- RPTT 125 Clinical Application 2 (1)** Continuation of RPTT 115, with emphasis on the application of skills and techniques learned in RPTT 120 and 121. *Sp; preq. RPTT 101, 110, and 115; 8 clinical*
- RPTT 130 Pediatric and Neonatal Respiratory Care (4)** Study of the pathology, pathophysiology, diagnosis, and treatment of diseases of the newborn and pediatric patient. Topics include developmental and comparative anatomy and physiology and specific respiratory care considerations required for these age groups. *Su; preq. RPTT 120, 121, 125, 131, and 200*
- RPTT 131 Pulmonary Function Testing (2)** Study of the methods used for testing the function of the lungs. Topics include the indications and standards for testing, equipment used, interpretation, and quality control systems. *Sp; preq. RPTT 101, 110, and 115*
- RPTT 132 Arterial Blood Gases/Acid Base (1)** Study of the techniques for collecting and analyzing arterial blood samples and detailed discussion of the interpretation of results. Emphasis on acid-base, fluid, and electrolyte balance and regulation. *Su; preq. RPTT 120, 121, 125, 131, and 200*
- RPTT 133 Laboratory Procedures (1)** Laboratory practice of the skills discussed in RPTT 131 and 132. *Su; preq. RPTT 120, 121, 125, 131, and 200*
- RPTT 135 Clinical Application 3 (2)** Continuation of RPTT 125, with emphasis on those skills developed in RPTT 131, 132, and 133. *Su; preq. RPTT 120, 121, 125, 131, and 200*
- RPTT 200 Pharmacology (3)** Study of the general principles of pharmacology, including drug types, methods of administration, dosage, effects, indications, contraindications, and regulation. Drug groups related to respiratory care are emphasized, including bronchodilators, wetting agents, mucolytics, antibiotics, muscle relaxants, and corticosteroids. *Sp; preq. RPTT 101, 110, and 115*
- RPTT 201 Continuous Mechanical Ventilation (6)** Study of the therapeutic and diagnostic techniques used for patients receiving mechanical ventilatory support. Topics include the selection process for ventilators, indications and hazards of mechanical ventilation, maintenance of patients, respiratory and hemodynamic monitoring, and weaning of patients from ventilatory support. *F; preq. RPTT 130, 132, 133, and 135; 5 lec. 3 lab*
- RPTT 202 Pathophysiology (3)** Study of the etiology, diagnosis, pathophysiology, and treatment of some of the most commonly encountered cardiopulmonary diseases. Topics include chronic obstructive pulmonary diseases and common restrictive, pleural, occupational, and cardiac related diseases. *Su; preq. RPTT 120, 121, 125, 131, and 200*
- RPTT 205 Clinical Application 4 (2)** Continuation of RPTT 135 with emphasis on the skills and techniques learned in prerequisite courses. *F; preq. RPTT 130, 132, 133, and 135; 16 clinical; \$9.00*
- RPTT 210 Critical Care (3)** Study of the assessment, monitoring, and treatment of the acutely ill and traumatized patient. *W; preq. RPTT 201 and 205*
- RPTT 211 Advanced Cardiopulmonary Assessment (1)** Study of advanced techniques for the monitoring of cardiopulmonary function. *W; preq. RPTT 201 and 205*
- RPTT 212 Pulmonary Rehabilitation and Home Care (1)** Study of the care and management of patients receiving pulmonary rehabilitation or home care. Topics include patient selection, education, follow-up, program design, progress assessment, regulatory implications, and equipment. *W; preq. RPTT 201 and 205*

RPTT 213 - SOCI 299

RPTT 213 Department Management (1) Introduction to the organization, planning, and management of, as well as the effect of current governmental regulations on, respiratory services. *W; req. RPTT 201 and 205*

RPTT 215 Clinical Application 5 (3) Continuation of RPTT 205, with emphasis on the skills and techniques learned in RPTT 201. *W; req. RPTT 201 and 205*

RPTT 220 Seminar (4) Designed to provide final curricular preparation for graduation. Includes oral case presentation, program assessment, systematic content review, and a comprehensive, cumulative student evaluation. *Sp; coreq. RPTT 225*

RPTT 225 Clinical Application 6 (8) Continuation of RPTT 215 with emphasis on skills and knowledge developed in RPTT 130, 201, 210, 211, 212, and 213. *Sp; req. RPTT 115, 125, 135, 205, and 215*

Sociology

SOCI 101 Introduction to Sociology (4) Studies the nature of human society and factors affecting its development, including concepts of culture, groups, organizations, collective behavior, and institutions. Required course for all social science majors. *Su F W Sp*

SOCI 110S Foundations of Social Science (4) Introduction to the methods and concerns of social science. Studies perspectives of anthropology, economics, history, geography, political science, psychology, and sociology as related to specific themes or topics. *Su F W Sp*

SOCI 150 Principles of Statistics (4) Cross-listed as MATH 150 and PSYC 150. Introduction to the vocabulary, concepts, formulas, and presentation of statistics as applied to business, education, and science. Topics include measures of central tendency and dispersion, probability applied to joint probability tables and Bayes' Theorem, probability distributions with emphasis on Binomial and Normal, sampling practices and theory, and calculator and computer use. *Su F W Sp; req. MATH 101*

SOCI 199 Special Topics in Sociology (1-4) Individual or small-group study, under the supervision of instructor, of topics not otherwise available to students.

SOCI 201 Introduction to Social Welfare (4) Overview of the field of social welfare: fundamental concepts and services in social welfare, social policies, historical development. *Offered as demand indicates.*

SOCI 204 Introduction to Social Work (4) Introduces students to the profession of social work. Includes an overview of the historical development of social work as a profession; social work practices with individuals, groups, and communities; and theory and practice of social work. *F Sp*

SOCI 205 Current Social Problems (4) An overview of major perspectives on social problems and their relevance in contemporary life. Topics include poverty, sexism, racism, aging, alienation, crime, human ecology, and colonialism in the third world. *F; req. SOCI 101*

SOCI 206 Social Institutions (4) Examines the major institutions: family, economy, religion, government, and health and medicine. Other important areas of study include populations and urbanization, the natural environment, collective behavior, social systems, and social change. *F Sp*

SOCI 224 Urban Sociology (4) Ecological and nonecological theories are used to study the processes of urbanization and the involvements and problems of the urban community. *Offered as demand indicates; req. SOCI 101*

SOCI 234 Sociology of Aging (4) Various aspects of aging are examined with special emphasis on theories of aging, demographics, physical, psychological, and sociological aspects of the aging process. *Sp*

SOCI 299 Topics in Sociology (1-4) Separate courses repeatable for credit on topics not otherwise available to students.

- SOCI 303 Introduction to Social Psychology (4)** Cross-listed as PSYC 303. Behavior of the individual as influenced by other individuals, social groups, and culture. Examines group dynamics, leadership, attitude, and group conflict. *Offered as demand indicates; preq. PSYC 101 or SOCI 101*
- SOCI 305 Social Work Practice (4)** Social work theory, methodology, and application. Areas of study include theory and concept formation, research design, data collection, client-worker relationship, interviewing, and problem-solving. *W; preq. SOCI 201 or 204*
- SOCI 307 Sociology of Work (4)** Examines the history, methods, and context of work. Emphasis on the sociological perspectives of work, industry, and occupations. The future of the workplace is examined. *Infrequently offered; preq. SOCI 101*
- SOCI 310 Gender Socialization (4)** Focuses on the socio-cultural dynamics involved in the socialization process. Examines differential expectations, male and female identity formation, sex roles in the family, occupational stereotypes, and the changing nature of sex roles. *F W; preq. SOCI 101*
- SOCI 311 Human Sexuality (4)** Cross-listed as PSYC 311. An in-depth view of the current status of human sexuality in the U.S. Examines current research; modes of sexual expression and enhancement; physiological, sociological, and psychological basis of human sexuality; sexual variations; and sex ethics. *F; preq. SOCI 101*
- SOCI 312 Sociology of Religion (4)** General theories concerning the place of religion in social processes. Religion and its place in the modern world, secularization, fundamentalism, new movements; religion in relation to class, ethnicity, gender, politics, and education. Durkheim's work on religion as the basis of social order and Weber's work on religion and the rationalization process are emphasized. *F; preq. SOCI 101*
- SOCI 320 Sociology of Culture (4)** Introduction to the fascinating and complex concept of culture, which is shown to vary in complexity, inventiveness, cohesion, and totality. Various theories of culture are explored. This course reveals how culture has developed over history, with special emphasis on industrialization and the postmodern world. *Sp, preq. SOCI 101*
- SOCI 325 Sociology of the Family (4)** Historical perspective for understanding American family systems. Of central concern are the contemporary marriage process and context, family relationships, sexuality, family dysfunctions, and changes. *W; preq. SOCI 101*
- SOCI 326 Small Group Dynamics (4)** Analysis of small-group structure and processes; examination of roles, interpersonal relations, and leadership; and current theory and research on small group interaction. *Sp odd years; preq. SOCI 101*
- SOCI 330 Social Theory (4)** A study of major classical and contemporary sociological theories and their exponents. *W; preq. SOCI 101*
- SOCI 340 Sociology of Appalachia (4)** Intensive study of Appalachia from sociological perspective. Emphasizes demography of Appalachia, sub-cultural characteristics, religion, arts and crafts, social change, and community power in Appalachia. *Sp even years; preq. SOCI 101 or by permission*
- SOCI 360 Drugs/Substance Abuse (4)** Cross-listed as BUHE 360, PSYC 360, and HPER 360. An in-depth study of alcohol, tobacco, and other drugs and how chemical dependency on these drugs can affect individual performance and behavior. *F W Sp*
- SOCI 380 Sociological Methods (4)** Overview which includes scientific method, measurement, experimentations, survey research, observational methods, case study techniques, and content analysis. *Sp even years; preq. SOCI 101*
- SOCI 399 Special Topics in Sociology (1-4)** Individual or small-group study, under the supervision of instructor, of topics not otherwise available to students.
- SOCI 400 Complex Organizations (4)** Sociological analysis of complex organizations. Topics include theories, types of organizations, organizational change and conflict, and research in organizations. *Offered as demand indicates; preq. SOCI 101*

SOCI 403 - SPAN 212

SOCI 403 Field Experience in Social Work (4) Controlled experience in a social work setting supervised by a qualified professional in an established agency. Designed to expose students to realistic conditions and "hands-on" learning. *Infrequently offered; preq. SOCI 204 and 305*

SOCI 405 Death and Dying (4) Cross-listed as PSYC 405. Focus on increased ability to deal with one's own mortality; skills for working with terminally ill and their families; understanding the complex social system of death in American society; and moral, ethical, and philosophical issues surrounding death. *F; preq. PSYC 101 or SOCI 101*

SOCI 410 Social Stratification (4) Analyzes stratification in the U.S. and other societies, focusing on income and wealth, role of family and education on social mobility, and inequality and influence of social class on public policy. *Offered as demand indicates; preq. SOCI 101*

SOCI 425 Industrial Sociology (4) Focuses on the growth of technology in the U.S. Emphasizes the social organization of industry, life in the work place, and the organizational culture. *Offered as demand indicates; preq. SOCI 101*

SOCI 429 Contemporary Minority Relations (4) Basic approaches are used to analyze American minority groups and their contemporary situation. Special emphasis is placed on patterns of prejudice and discrimination as well as the dynamics of race relations. *Offered as demand indicates; preq. SOCI 101*

SOCI 444 Social Deviance (4) Examination of the concept of deviance in sociology and its implications for the study of contemporary social behavior. How people develop a concept of some being different from others and act on this definition. Possible topics include mental illness, crime, sexual deviance, nonconformity, and subcultures of deviance. *Offered as demand indicates; preq. SOCI 101*

SOCI 450 Sociology of Occupations and Professions (4) Sociological analysis of contemporary occupations and professions in the U.S., social stratifications in the workplace, technology, and the individual in the workplace. *Offered as demand indicates; preq. SOCI 101*

SOCI 490S Senior Seminar (4) Provides an opportunity for students to place their chosen field of study in an interdisciplinary context with intellectual, ethical, and historical perspectives. The seminar focuses on the synthesis and integration of various concepts by applying them to the analysis and solution of problems chosen in the context of their academic disciplines. Oral and written presentations of the seminar paper are required. *Su F W Sp; preq. senior standing and 44 general education program hours*

SOCI 499 Special Topics in Sociology (1-4) Individual or small-group study, under the supervision of instructor, of topics not otherwise available to students. Separate courses repeatable for credit. *Preq. SOCI 101*

Spanish

SPAN 111 Elementary Spanish 1 (4) Development of comprehension, speaking, reading, and writing skills in a cultural context. Basic grammar. Lab required. Initial course of three-quarter, first-year sequence. *Su F W Sp; \$5.00*

SPAN 112 Elementary Spanish 2 (4) Continuation of SPAN 111. *F W Sp; preq. SPAN 111; \$5.00*

SPAN 113 Elementary Spanish 3 (4) Continuation of SPAN 112. *F W Sp; preq. SPAN 112; \$5.00*

SPAN 211 Intermediate Spanish 1 (4) Offers selected readings in Hispanic issues and literature to continue the development of communicative skills. Lab required. *F W Sp; preq. SPAN 113 or 2-3 years of high school Spanish; \$5.00*

SPAN 212 Intermediate Spanish 2 (4) Continuation of SPAN 211. *F W Sp; preq. SPAN 211 or instructor's approval; \$5.00*

SPAN 213 - THAR 135

SPAN 213 Intermediate Spanish 3 (4) Emphasizes the ability to read with detailed understanding, creative and accurate use of vocabulary items, use of subordinate structures in oral communication, and the ability to communicate in writing using complex sentence structures. *F W Sp; req. SPAN 212 or instructor's approval; \$5.00*

SPAN 311 Composition and Conversation (4) A follow-up to SPAN 213 with special emphasis on oral proficiency and applied grammatical concepts. In preparation to reading and writing, contemporary videos and films are used to stimulate discussion. *Offered on demand; req. SPAN 213 or fluency in Spanish communicative skills*

SPAN 399 Special Topics (1-4) Designed for native speakers of Spanish or non-native speakers who have acquired communicative skills in the language. The course analyzes the work of contemporary Latin-American writers, as well as Hispano-American writers in the U.S. *Offered on demand; req. native speaker fluency in communicative skills (listening, speaking, reading, and writing)*

Speech

SPCH 103 Public Speaking and Human Communication (3) Principles of public speaking and practice in presenting informative and persuasive speeches with emphasis on the human communication process. *Su F W Sp*

SPCH 105 Introduction to Mass Communication (4) Cross-listed as JOUR 105. Study of all forms of mass communication, including newspapers, magazines, radio-television, book publishing, public relations, advertising, and photojournalism. Begins with an analysis of communication process and ends with media career opportunities. *Offered on demand*

SPCH 215 Group Discussion (4) Study of structure and internal dynamics of small groups, nature and functions of leadership and group participation, and problem solving and decision making. Frequent participation in group discussion activities. *Offered on demand*

SPCH 220 Oral Interpretation of Literature (4) Techniques of oral interpretation and development of adequate intellectual and emotional responsiveness to meaning of literature. *Offered on demand*

SPCH 299 Topics in Communications (1-4) Study of various topics not otherwise available to students. Repeatable for credit. *Offered on demand*

Theater

THAR 100 Introduction to Theater (4) Survey of development of theater from classical to modern times, emphasizing the artists and craftspersons of the theater and their contributions to its development. *F W Sp; \$10.00*

THAR 120 Introduction to Stagecraft (3) Scenic materials and techniques of planning and constructing stage scenery. Stage audience relationships and principles of technical production. *F W Sp*

THAR 121 Stage Lighting (3) Theory and practice in the mechanics and design of lighting for theatrical productions. *Sp*

THAR 122 Introduction to Costume (3) Principles of technical production. May be repeated for credit. *F W Sp; 2 lec. 1 lab*

THAR 132 Elements of Performance (4) Introduction to the elements of performance that create theater and drama, including text, performer, spectacle, spectator, and performance space. Attendance at university theater productions is required. *F W Sp; \$10.00*

THAR 135 Practicum in Production Design (2-4) Supervised lab practice in design and execution of scenery, lighting, costumes, properties, and sound. May be repeated for credit. *F W Sp; \$15.00*

THAR 205 - UNIV 102

THAR 205 Theater Planning and Management (3) Principles and practices of managing theatrical-producing organizations. Problems of finance, personnel, policy, program building, advertisement, publicity, and public relations. *W*

THAR 210 Acting 1 (4) Principles and techniques of acting with major emphasis on developing trust and freedom. Warm-up techniques, theater games, improvisation, monologue exercises, and preliminary scoring techniques underline this introduction to the work of the actor. *F W Sp; \$25.00*

THAR 211 Acting 2 (4) Continuation of training started in THAR 210, with addition of more detailed character development, scoring techniques, and ensemble considerations through duet scene work. *W Sp; \$10.00*

THAR 212 Acting 3 (4) For serious acting student, this course completes the second year sequential training program. Primary emphasis is to apply techniques learned in THAR 210 and 211 to more lengthy and complicated scene structures. Long duet scenes and multi-character scenes or short plays used for study and performance. Public performances are frequently incorporated into final work in this course. *Sp; \$10.00*

THAR 235 Practicum in Production Design (2-4) Supervised lab practice in design and execution of scenery, lighting, costumes, properties, and sound. May be repeated for credit. *F W Sp; req. instructor's permission; \$15.00*

THAR 237 Stage Make-up (2) Stage make-up materials and the art of pigment application. *F W Sp*

THAR 331 Directing 1 (4) Principles and practices of directing for stage. *F W Sp*

THAR 332 Theater History (3) Development of theater and drama. May be repeated for credit. *Offered on demand*

University

UNIV 101 Academic Development Skills (4) A course recommended for students who place into at least two developmental education courses and optional for any student on campus. Recommended for entering freshmen with a high school GPA of 2.0 or lower. Teaches study skills and test-taking techniques. Emphasis on goal setting, time management, notetaking, studying and marking textbooks, taking exams, finding and using learning resources, improving memory and concentration, and skimming and scanning. *Su F W Sp*

UNIV 102 Personal Development Skills (4) A course recommended for students who place into at least two developmental education courses and optional for any student on campus. Designed to help students improve their personal skills in order to become more involved members of the academic community and to have richer personal lives. Topics include attitudes, self-esteem, communication, wellness/health, anxiety and stress, creativity, problem-solving, money management/personal finance, career exploration, and orientation to university services. *Su F W Sp*

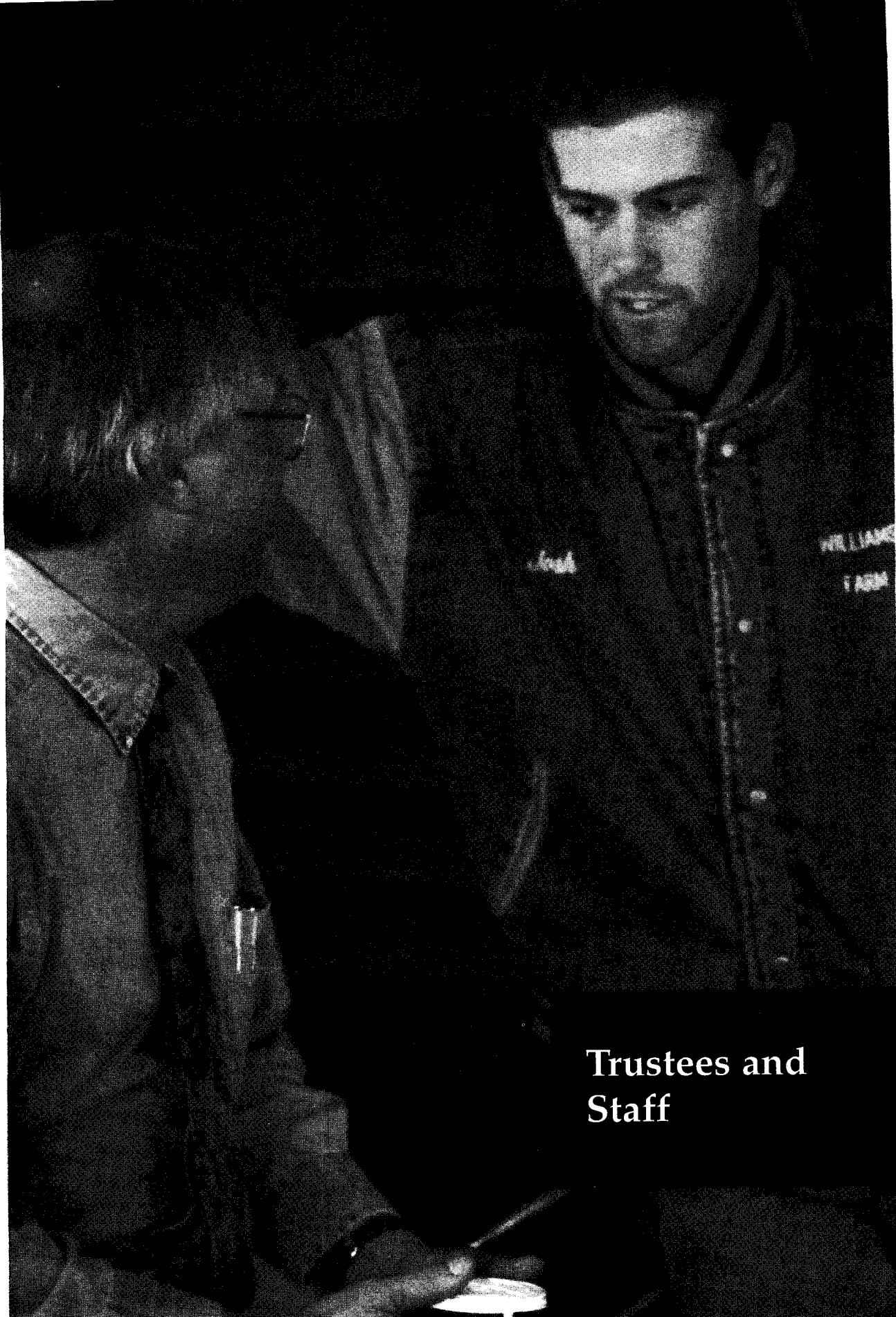

**Trustees and
Staff**

Board of Trustees

Thomas B. Reynolds, Chairperson
 Katherine A. Argeros
 George H. Clayton
 George L. Davis III
 Jeff M.S. Kaplan
 A. Burton Payne, M.D.
 Patricia J. Richards
 William J. Shkurti
 Frank L. Waller
 Ray Bear, Student
 Elizabeth Smith, Student

Administration

Arnzen, James W. (1988)
 Director, Athletics
 Head Basketball Coach
 B.S., Defiance College
 M.S., University of Dayton

Ballengee, Greg (1996)
 Assistant Controller
 A.S., Shawnee State Comm. College
 B.S., Miami University

Beckett, Gene (1983)
 Director, Dev. Ed./Learning Ctr.
 A.B., M.A., Ph.D., Ohio Univ.

Berry, Michael (1996)
 UIS Network Systems Manager
 A.A.S., B.S., Shawnee State University

Blanton, Lee B. (1996)
 Accountant
 B.S., Berea College

Bonzo, Phil (1993)
 Athletic Trainer
 Sports Information Director
 B.S., Shawnee State University

Boyles, Elinda C. (1988)
 Director, Personnel/Payroll/EEO
 B.S., Eastern Kentucky University
 M.Ed., University Nevada Las Vegas

Bradbury, Barbara L. (1980)
 Director, Upward Bound/Student Support Services
 B.S., Ohio University
 M.S., University of Dayton

Burchett, Mark (1991)
 Science Laboratory Assistant
 Department of Natural Sciences
 College of Arts and Sciences
 B.S., M.S., Morehead State Univ.

Carson, Pat L. (1984)
 Manager, Printing & Graphic Svcs.

Charles, Joanne T. (1979)
 Controller
 B.B.A., Temple University
 M.B.A., Morehead State University
 C.P.A.

Charles, Thomas K. (1979)
 Director, Career Planning and Place.
 A.S., Henry Ford Community Col.
 B.S., M.A., Western Michigan Univ.

Clay, Audrey C. (1996)
 Director, Financial Aid
 B.A., Bluefield State College
 M.S., Radford University

Cornwell, Kenneth (1994)
 Asst. Dir., Educational Opp. Ctr.
 B.A., George Washington University
 M.S., Univ. of California, San Diego

Culver, Tim (1990)
 Coordinator, STARS Program
 B.B.A., Ohio University
 M.B.A., Marshall University
 M.S.Ed., University of Dayton

Cummings, Mary Elizabeth (1988)
 Librarian, Reference
 B.S.Ed., Ohio University
 M.S.L.S., University of Kentucky
 M.A., Marshall University

Daehler, Carl (1995)
 Exec. Dir., Vern Riffe Ctr. for the Arts
 B.M.E., M.M.E., D.M.A., University of Michigan

Dandio, Greg (1995)
 Acting Dir., University Info. Systems
 B.S., Southern Connecticut St. Univ.

Day, Michael E. (1990)
 Accountant
 A.A.B., B.B.A., Shawnee State Univ.

Donohue, Stephen P. (1994)
 General Counsel/Asst. to the Pres.
 B.S., U.S. Military Academy
 J.D., Stetson Univ. College of Law

Duncan, William Peter (1983)
 Assoc. Director, Library/Media Svcs.
 B.S., Ohio University

Dunford, Linda (1992)
 Junior Accountant
 A.S., B.S., Shawnee State University

Edwards, Dave (1996)
 Director, Student Activities
 B.S., University of Evansville
 M.S.Ed., Southern Illinois University

Evans, Elaine N. (1994)
 Counselor (Talent Search)
 B.A., Anderson University
 M.S.W., The Ohio State University

Fatula, Karen (1995)
 Outreach Coordinator, EOC
 A.A., B.A., Ohio University

Folker, Valerie (1996)
 Reference Librarian
 B.F.A., University of Dayton
 B.A., Capitol University
 M.L.S., University of Kentucky

Gleason, David L. (1983)
 Director, Planning, Physical Facilities, and Construction
 B.S., Ohio University
 M.A., The Ohio State University
 Ph.D., Ohio University

Gregory, Stephen (1989)
 Director, Talent Search
 A.A.B., Hocking Technical College
 B.B.A., Ohio University
 M.S., University of Dayton

Gross, Carolyn (1990)
 Coordinator, Shawnee BASICS
 B.A., West Virginia Institute of Tech.
 M.A., West Virginia University

Grundler, Mark W. (1992)
 UIS Network Systems Manager
 A.S., Iowa Technical Institute
 B.S., University of Iowa

Hannah, William A. (1987)
 Coord., Instructional Material/Media
 B.S., Ohio University

Hanson, Allen (1992)
 Coord., University Center Operations
 M.S., Morehead State University

Harris, Joe (1996)
 Admission Officer
 B.S., Shawnee State University

Hartley, Jannette S. (1992)
 Librarian, Technical Services
 A.A., A.A.S., Highline Comm. Col.
 B.A., Washington College
 M.I.L.S., University of Michigan

Holt, Jerry G. (1990)

Dean and Professor, College of Arts and Sciences
B.S., Oklahoma State University
M.A., Ph.D., University of Oklahoma

Hughes, Michael J. (1990)

Dir., Counseling and Psych. Services
B.S., M.S., University of Scranton
Ed.D., West Virginia University

Kadel, James R. (1981)

Dean, Associate Professor
College of Professional Studies
B.A., D.D.S., The Ohio State Univ.
M.Ed., Cleveland State University
M.B.A., Ohio University

Keaton, Mary (1981)

Bookstore Manager

Kiser, Paula (1995)

Outreach Coordinator, EOC
B.S., Xavier University

Kotcamp, Lloyd (Butch) (1990)

Maintenance Supervisor

Lawson, Robert L. (1990)

Director, Continuing Education
B.S., University of Rio Grande
M.A., Marshall University
Ed.D., Nova University

Lawyer, Sandra K. (1991)

Counselor, Ohio Job Prep Program
A.I.S., Shawnee State University
B.B.A., M.Ed., Ohio University

Logan, Jennifer (1996)

Admission Officer
B.A., Shawnee State University

Madden, Jaime M. (1995)

UIS Network Systems Manager
B.S., University of Dayton

Madden, Paul M. (1992)

Director, Preprofessional Services
College of Arts and Sciences
B.S., University of Dayton

Maillet, Jacqueline (1994)

Coord., Housing and Residence Life
A.A., Shawnee State University
B.S.S., Ohio University

Mains, Urma (1994)

Counselor (Talent Search)
B.S.Ed., Ohio University
M.S.Ed., Xavier University

Malone, Mary Ann (1993)

Asst. Dir./Counselor, Student Support Services
B.S., Ohio Dominican College
M.A., Ohio University

Mangus, Larry L. (1995)

Vice President for Student Affairs
B.S., M.Ed., Ohio University
Ed.D., Indiana University

Matthews, Eustace P. (1990)

Director, Dept. of Ed. Needs Services
A.A., Shawnee State University
B.A., M.Ed., Ohio University

Maze, David (1995)

Outreach Coordinator, EOC
B.A., Northwestern University
M.Div., D.Min., Methodist
Theological School

Meeker, Judy (1991)

Coordinator, CSME/Tech Prep
A.S., B.A., Shawnee State University

Merb, Rick (1994)

Acting Assistant Director, Admission
B.S., M.Ed., Bowling Green St. Univ.

Midkiff, Stephen J. (1975)

Registrar
B.A., University of Kentucky
M.Ed., Harvard University
Ph.D., Ohio University

Midkiff, Tess D. (1975)

Director, Library/Media Services
B.A., University of Kentucky
M.L.S., Simmons College

Moore, Mark A. (1987)

Assistant Registrar
A.A.S., Shawnee State Comm. Col.
B.A., Ohio University

Moore, Patricia J. (1971)

Executive Assistant to the President
A.S., Shawnee State University
B.B.A., Ohio University
M.S.Ed., University of Dayton

Mowery, Steven D. (1992)

Systems Analyst/Programmer
A.A.B., Shawnee State University

Mullins, Cathy (1990)

Asst. Director, Special Programs
Continuing Education
B.S., M.B.A., Ohio University

Murphy, Roger T. (1996)

Vice President for Business Affairs
B.A., M.B.A., Michigan State Univ.

Nevious, William A. (1996)

Vice President for Academic Affairs
and Provost and Professor
B.S., M.S., Ph.D., South. Illinois Univ.

Pauley, Amy (1997)

Program Assistant, Upward Bound
B.A., M.A., Marshall University

Pinson, Michael (1990)

UIS Tech Support Manager
A.A.S., Shawnee State University

Powell, Sherri (1989)

Administrative Assist. to the Provost
A.A.B., Shawnee State Comm. Col.
B.B.A., Ohio University

Ramey, Virginia C. (1984)

Director, Tech Prep
B.S.Ed., M.B.A., Ohio University

Rase, Lois (1993)

Coordinator, BEARS Program
B.S., M.S., Ohio University

Redoutey, Teresa (1994)

Coord., Academics and Assessment
B.S., Ohio University
M.S.Ed., University of Dayton

Salyers-Stoner, Connie E. (1988)

Assoc. Director, Library/Public Svcs.
B.S., Wright State University
M.L.S., George Peabody College for Teachers

Schlosser, Leo A. (1995)

Tech. Dir., Vern Riffe Ctr. for the Arts
B.A., Northern Kentucky State Col.
M.F.A., Ohio University

Shelpman, Suzanne (1991)

Director, Admission and Retention
B.A., M.A., Marshall University

Stamper, Amy (1996)

Coord., Clinical and Field Experience
College of Arts and Sciences
B.S., Shawnee State University

Taylor, Dale F. (1988)

Counselor, Ohio Job Prep Program
A.I.S., Shawnee State Comm. Col.
B.G.S., Ohio University
M.H.E., Morehead State University
L.S.W., State of Ohio

Veri, Clive C. (1989)

President and Professor
B.S., State Univ. of N. Y. at Oswego
M.A., University of Maryland
Ph.D., University of Nebraska

Vince, Dennis (1996)

Outreach Coordinator, EOC
B.S., Ohio University
M.S.Ed., Kent State University
M.S.Ed.Adm., University of Dayton

Walker, Charles Melton (1987)

Systems Analyst/Programmer
A.A.B., Shawnee State University
B.A., Ohio University

Warman, Randy (1992)

Coordinator, Student Activities and
Leadership Development
B.S., Ohio University

Warsaw, Susan S. (1983)

Director, Development
B.A., The Ohio State University

Watson, Deborah, E. (1991)

Counselor, Ohio Job Prep Program
B.A., M.A., Morehead State Univ.

White, Wayne (1993)

Director, Ohio Appalachian Center
for Higher Education
M.A.Ed.Admn., Ohio University

Wilburn, Teresa (1991)

Systems Analyst/Programmer
A.A.S., B.B.A., Shawnee State Univ.

Wilkinson, James (1997)

Assistant Athletic Director
B.A., Manchester College
M.Ed., Miami University

Wilson, Amy (1995)

Outreach Coordinator, EOC
B.F.A., Indiana University
M.S.Ed., Marshall University

Young, F. Daniel (1990)

Assistant Director, Facilities
A.I.E., Muskingum Area Tech. Col.

Faculty

Alex, Alexander V. (1988)

Professor, Economics
College of Arts and Sciences
B.A., Kerala University
M.A., Banaras University
M.A., Ph.D., Indiana University

Basham, Julia L. (1982)

Chairperson, Associate Professor
Department of Natural Sciences
College of Arts and Sciences
B.A., B.S., M.S., Univ. of Cincinnati
M.S., Marshall University

Bauer, Jeffrey A. (1987)

Professor, Geology
College of Arts and Sciences
B.S., Bowling Green State University
M.S., Ph.D., The Ohio State Univ.

Boukaabar, Kaddour (1990)

Assoc. Prof., Mathematical Sciences
College of Arts and Sciences
B.S., University of Wahran, Algeria
M.S., Florida Institute of Technology
Ph.D., Bowling Green State Univ.

Bryson, Nancy M. (1991)

Assistant Professor, Chemistry
College of Arts and Sciences
B.S., Mississippi Univ. for Women
M.A.T., Mississippi State University
Ph.D., University of South Carolina

Buchanan, Dawna Lisa (1991)

Associate Professor, Education
College of Arts and Sciences
B.A., Brock University
M.A., Ph.D., The Ohio State Univ.

Burke, Robbie A. (1974)

Professor, Management
College of Professional Studies
B.A., West Virginia Wesleyan
M.S., M.B.A., Marshall University

Byrne, Francis X. (1987)

Professor, English/Linguistics
College of Arts and Sciences
B.A., M.A., Colorado State Univ.
M.A., Ph.D., University of Arizona

Canter, Mary Ann (1987)

Clinic Coordinator, Asst. Professor
Respiratory Therapy
College of Professional Studies
B.S.A.S., Youngstown State Univ.
M.H.S.A., Ohio University

Carnevale, Thomas A. (1991)

Chairperson, Professor
Department of Mathematical Sciences
College of Arts and Sciences
B.S., St. Francis College
M.S.T., Fordham University
D.A., Idaho State University

Chaffin, Cathy M. (1980)

Assoc. Prof., Office Administration
College of Professional Studies
B.S., Berea College
M.B.E., Morehead State University

Chrisman, Elizabeth A. (1980)

Associate Professor, Dental Hygiene
College of Professional Studies
A.A.S., Scioto Technical College
B.S., M.Ed., Ohio University

Christen, William L. (1996)

Chairperson, Associate Professor
Department of Teacher Education
College of Arts and Sciences
B.S., M.S., Winona State College
Ed.S., Mankato State College
Ed.D., Arizona State University

Christensen, Margaret (1996)

Program Coordinator, Assistant
Professor, Health Management
College of Professional Studies
R.N., St. Francis School of Nursing
B.G.S., Wichita State
M.Ed., Univ. of Central Oklahoma
Ed.D., Oklahoma State University

Coll, Julia R. (1987)

Associate Professor, Spanish
College of Arts and Sciences
Licenciada en Educacion,
Universidad de Oriente
M.A., M.Ed., Ph.D., Univ. of Arizona

Crothers, Shirley Evans (1968)

Associate Professor, Vocal Music
College of Arts and Sciences
B.S., The Ohio State University
M.F.A., Ohio University

Crummie, Karen S. (1993)

Program Coordinator, Assistant
Professor, Legal Assisting
College of Professional Studies
B.A., Mount Vernon Nazarene Col.
J.D., Valparaiso Univ. School of Law

Day, D. James (1987)

Professor, Management
College of Professional Studies
B.S., West Liberty State College
M.B.A., Eastern New Mexico Univ.
Ph.D., The University of Iowa

Deal, D. Robert (1988)

Associate Professor, Biology
College of Arts and Sciences
B.A., Capital University
M.A., Miami University
Ph.D., Cornell University

Diamond, Roger A. (1990)

Asst. Prof., Engin. Graphics/CADD
College of Professional Studies
B.S., M.Ed., California Univ. of Penn.

Dillard, Mary L. (1989)

Professor, English
Developmental Education
B.S.Ed., M.S.T., Georgia South. Col.
Ed.D., University of Tennessee

Dillon, Mary E. (1983)

Asst. Prof., Assoc. Degree Nursing
College of Professional Studies
B.S.N., Ohio University

Doster, Steven J. (1989)

Associate Professor, Accounting
College of Professional Studies
B.S., The Col. of William and Mary
M.B.P.A., Southeastern University
C.P.A., C.M.A.

Duncan, Barbara S. (1980)

Associate Professor, Dental Hygiene
College of Professional Studies
A.A.S., Scioto Technical College
B.S., M.Ed., Ohio University

Dzik, Anthony J. (1988)

Associate Professor, Geography
College of Arts and Sciences
B.A., Roosevelt University
M.A., University of Toledo
Ph.D., Northwestern University

Essman, Larry C. (1976)

Program Coordinator, Associate
Professor, Accounting
College of Professional Studies
B.A., M.A., Ohio University
C.P.A.

Essman, Loretta Jenkins (1982)

Assistant Professor, Accounting
College of Professional Studies
A.A.B., Shawnee State Comm. Col.
B.B.A., M.Ed., Ohio University

Estep, Larry M. (1972)

Program Coord., Business Admin.
Associate Professor, Management
College of Professional Studies
B.B.A., Ohio University
M.S., M.B.A., Marshall University

Ferguson, Orville R. II (1989)

Associate Professor, Mathematics
Developmental Education
B.S., West Virginia State University
M.S. Ed. Adm., Xavier University

Flavin, James P. (1983)

Professor, English
College of Arts and Sciences
B.A., M.A., Ft. Hays Kansas St. Univ.
Ph.D., Miami University

Forrey, Robert J. (1989)

Professor, English
College of Arts and Sciences
B.A./M.A., Wesleyan University
Ph.D., Yale University

Frazer, R. Thomas (1967)

Associate Professor, Chemistry
College of Arts and Sciences
B.S., Marshall University
M.S., Iowa State University

Gallaher, Janna B. (1991)

Asst. Prof., Computer Eng. Tech.
College of Professional Studies
B.S., St. Louis University
M.S., University of Missouri
P.E.

Gampp, Anna R. (1971)

Assoc. Prof., Assoc. Degree Nursing
College of Professional Studies
B.S.N., The Ohio State University
M.Ed., Ohio University

Gearheart, Phillip H. (1987)

Professor, Art
College of Arts and Sciences
B.A., Wichita State University
M.S., M.F.A., Indiana University

Gemmer, Gary P. (1983)

Assoc. Prof., Physics/Physical Sci.
College of Arts and Sciences
B.S., Morehead State University
M.A.T., Miami University

Goetting, Melvin J. (1987)

Program Coord., Mgt. Info. Systems
Asst. Prof., Business Info. Systems
College of Professional Studies
B.B.A., M.B.A., University of Toledo

Gulker, Emily E. (1965)

Associate Professor, Speech
College of Arts and Sciences
B.S.Ed., The Ohio State University
M.A., Marshall University

Hadjiyannis, Stylianos I. (1989)

Associate Professor, Political Science
College of Arts and Sciences
B.A., California State University
M.A., Ph.D., University of California

Hagen-Smith, Robin G. (1984)

Senior Instructor, Physical Education
College of Arts and Sciences
B.S., Rio Grande College
M.Ed., Xavier University

Hamilton, Virginia M. (1987)

Assoc. Prof., Mathematical Sciences
College of Arts and Sciences
B.A., M.S., Ball State University

Hanlon, William J. (1988)

Asst. Prof., Business Info. Systems
College of Professional Studies
B.S., University of Pittsburgh
M.B.A., Cleveland State University
C.D.P.

Harris-Fain, Darren (1995)

Assistant Professor, English
College of Arts and Sciences
A.B., Ohio University
M.A., Ph.D., Kent State University

Herrmann, Sibylle R. (1969)

Assoc. Professor, Biological Sciences
College of Arts and Sciences
B.S., Ohio University
M.S., University of Michigan

Hilgarth, Carl O. (1990)

Coordinator, Assistant Professor
Computer Engineering Technology
College of Professional Studies
B.S., The City College of New York
M.S., University of Missouri-Rolla

Huang, Xiaodan (1993)

Associate Professor, Education
College of Arts and Sciences
B.A., Nanchang Teachers College
M.Ed., St. Bonaventure University
Ph.D., Cornell University

Humble, Jeffery S. (1989)

Senior Instructor, Plastics Eng. Tech.
College of Professional Studies
B.S., Ball State University

Irwin, C. Ray (1971)

Assoc. Prof., Electromech. Eng. Tech.
College of Professional Studies
B.S.E.E., M.Ed., Ohio University

Ison, Steven A. (1996)

Asst. Prof., Environmental Eng. Tech.
College of Professional Studies
B.S.I.E., Texas Tech University
M.S.I.E., Purdue University
M.S.M., Troy State University

Kehres, Edward C. (1996)

Sr. Instructor, Occupational Therapy
College of Professional Studies
B.S., M.S., The Ohio State University

Kelley, John L. (1969)

Assoc. Prof., History/Political Science
College of Arts and Sciences
B.A., Marian College
M.A., Indiana University
Ph.D., Ohio University

Kiser, Joyce A. (1972)

Program Coordinator, Associate
Professor, Office Administration
College of Professional Studies
B.A., M.B.E., Morehead State Univ.

Kiser, Shannon (1972)

Associate Professor, English
College of Arts and Sciences
B.A., Morehead State University
M.A., University of Kentucky

Kosan, Julius Ted (1990)

Asst. Professor, Computer Eng. Tech.
College of Professional Studies
B.S., M.S., Bowling Green State Univ.

Kunkle, Barbara K. (1981)

Associate Professor, English
College of Arts and Sciences
B.A., University of Kentucky
M.A., Marshall University

Leedom, Wm. Patric (1993)

Associate Professor, Education
College of Arts and Sciences
B.A., San Francisco State University
M.Ed., Xavier University
Ed.D., University of Cincinnati

Li, Jinlu (1989)

Assoc. Prof., Mathematical Sciences
College of Arts and Sciences
B.S., Beijing University
Ph.D., Wayne State University

Lonney, Larry W. (1989)

Assistant Professor, Physics
College of Arts and Sciences
B.S., Illinois State University
M.S., Purdue University
Ph.D., Washington State University

Lorentz, John H. (1990)

Associate Professor, History
College of Arts and Sciences
B.A., Miami University
M.A., Harvard University
Ph.D., Princeton University

Lubno, Mary Ann (1997)

Chair, Associate Professor, Nursing
College of Professional Studies
B.S.N., Virginia Commonwealth Univ.
M.S.N., Medical College of Georgia
Ph.D., University of Texas

Marsh, Eleanor A. (1976)

Assoc. Prof., Sociology/Anthropology
College of Arts and Sciences
B.A., Washington State College
M.A., Washington State University
M.B.A., Ohio University

Mason, Vivian (1995)

Assistant Professor, Theatre
College of Arts and Sciences
B.A., University of Massachusetts
M.F.A., Univ. of Wisconsin, Madison

Massie, Gayle D. (1982)

Assoc. Prof., Associate Degree Nursing
College of Professional Studies
B.S.N., Spalding University
M.S.N., University of Tennessee

Mauldin, Robert (1994)

Associate Professor, Natural Sciences
College of Arts and Sciences
B.S., Ph.D., University of Tennessee

McHenry, Candace (1991)

Senior Instructor, Education
College of Arts and Sciences
B.S., Ohio University
M.A., Marshall University

Medak, Frederick M. (1995)

Asst. Prof., Mathematical Sciences
College of Arts and Sciences
B.S., University of Washington
M.S., University of Utah
Ph.D., Iowa State University

Meriwether, Nicholas K. (1996)

Assistant Professor, Philosophy
College of Arts and Sciences
B.A., Hendrix College
M.A., Trinity Divinity School
Ph.D., Purdue University

Miller, James M. (1989)

Assistant Professor, Social Sciences
College of Arts and Sciences
B.S., Manchester College
Ph.D., Kent State University

Milliken, Roberta L. (1996)

Assistant Professor, English
College of Arts and Sciences
B.A., M.A., Ohio University
Ph.D., University of Toledo

Miner, Edward C. (1983)

Chairperson, Professor
Sociology and Psychology
Department of Social Sciences
College of Arts and Sciences
B.A., Youngstown State University
M.A., Kent State University
Ph.D., Kent State University and
Akron University

Mirabello, Mark L. (1987)

Associate Professor, History
College of Arts and Sciences
B.A., University of Toledo
M.A., University of Virginia
Ph.D., Univ. of Glasgow (Scotland)

Moore, Dan M. (1988)

Associate Professor, Management
College of Professional Studies
B.S., University of Virginia
M.B.A., D.B.A., Georgia State Univ.

Murray, Nancy L. (1992)

Instructor, Dental Hygiene
College of Professional Studies
B.S., The Ohio State University

Ng, Joseph S. (1996)

Assistant Professor, English
College of Arts and Sciences
B.A., Shue Yan University
M.A., Univ. of Southwestern Louisiana
Ph.D., Illinois State University

Nickel, Linda K. (1978)

Associate Professor, Dental Hygiene
College of Professional Studies
A.A.S., Scioto Technical College
B.S., M.Ed., Ohio University

O'Connor, Christopher S. (1992)

Assoc. Prof., Mathematical Sciences
College of Arts and Sciences
B.A., Univ. of Cal. at Santa Cruz
M.S., San Jose State University
Ph.D., University of Oregon

Oliver, Scott D. (1976)

Professor, Biological Sciences
College of Arts and Sciences
D.D.S., M.S., The Ohio State Univ.

Osborne, Dane H. (1988)

Assistant Professor, Physical
Therapist Assistant Program
College of Professional Studies
B.S., The Ohio State University
M.Ed., Ohio University

Palguta, Kathryn E. (1996)

Assistant Professor, English
College of Arts and Sciences
B.A., University of Cincinnati
M.A., University of Akron
Ph.D., Kent State University

Pambookian, Hagop S. (1987)

Professor, Psychology
College of Arts and Sciences
B.A., American University of Beirut
M.A., Columbia University
Ph.D., University of Michigan

Penn, William H. (1977)

Associate Professor, Computer Aided Drafting and Design
College of Professional Studies
B.S.A.S., Miami University
M.Ed., Ohio University

Perry, Catherine O. (1990)

Chairperson, Associate Professor
Dept. of Occupational Therapy
College of Professional Studies
B.S., The Ohio State University
M.Ed., University of North Carolina

Priode, Carl E. (1985)

Coordinator, Assistant Professor
Electromechanical Engineering Tech.
College of Professional Studies
B.S.E.T., Franklin University

Rader, Steven D. (1996)

Assistant Professor, Sports Studies
College of Arts and Sciences
B.S.P.E., M.S.A., Ph.D., Ohio Univ.

Raiser, Lane C. (1989)

Assistant Professor, Art
College of Arts and Sciences
B.A., Kutztown State College
M.F.A., Brooklyn College

Renfroe, Brenda S. (1991)

Senior Instructor, Radiologic Tech.
College of Professional Studies
A.A.S., B.U.S., Morehead State Univ.

Roberts, Jane M. (1981)

Asst. Prof., Assoc. Degree Nursing
College of Professional Studies
B.S.N., University of Kentucky
M.S.N., University of Tennessee

Ruby, Jerry L. (1988)

Assoc. Prof., Finance/Management
College of Professional Studies
B.B.A., Ohio University
M.B.A., Morehead State University

Scherer, Roger C. (1991)

Assoc. Professor, Plastics Eng. Tech.
College of Professional Studies
B.S., California St. Polytechnic Univ.
M.A., California State University

Scott, Edmon N. (1978)

Coordinator, Assistant Professor
Instrumen. and Control Eng. Tech.
College of Professional Studies
B.S., Bowling Green State University

Scott, Sharon M. (1978)

Assoc. Prof., Assoc. Degree Nursing
College of Professional Studies
A.D.N., B.S.N., M.Ed., Ohio Univ.
M.S.N., Bellarmine College

Sherman, Martha J. (1991)

Associate Professor, Education
College of Arts and Sciences
B.S., Missouri Western College
M.E., University of North Florida
Ph.D., Purdue University

Simon, Kathleen M. (1971)

Professor, English
College of Arts and Sciences
B.A., M.A., Eastern Kentucky Univ.
Ph.D., Ohio University

Sissel, Melinda D. (1988)

Instr., Occupational Therapy
College of Professional Studies
A.A.S., Shawnee State Comm. Col.

Smith, Lyle B. (1975)

Coordinator, Assistant Professor
Plastics Engineering Technology
College of Professional Studies
B.S., Ohio University

Stafford, Donna K. (1997)

Assistant Professor, Psychology
College of Arts and Sciences
B.A., M.S., Northeast Louisiana Univ.
Ph.D., University of Memphis

Staton, Pamela J. (1988)

Chairperson, Associate Professor
Medical Laboratory Technology
College of Professional Studies
B.S., Morehead State University
M.S., West Virginia University

Stead, Thomas D. (1969)

Associate Professor, Art
College of Arts and Sciences
B.F.A., M.F.A., Ohio University

Strunk, Priscilla A. (Sunny) (1984)

Instructor, Respiratory Therapy
College of Professional Studies
A.A.S., Shawnee State University

Sykes, William W. (1981)

Chairperson, Associate Professor
Radiologic Technology
College of Professional Studies
A.A.S., Central Ohio Technical Col.
B.S., The Ohio State University
M.B.A., Xavier University

Syroney, Jeanie (1990)

Instructor, Emergency Med. Tech.
College of Professional Studies
A.A.S., Shawnee State University
B.S.N., Capital University

Thiel, Becky A. (1981)

Asst. Prof., Assoc. Degree Nursing
College of Professional Studies
B.S.N., The Ohio State University
M.S.N., University of Tennessee

Thomas, Donald L. (1986)

Chairperson, Associate Professor
Respiratory Therapy
College of Professional Studies
A.S., Kettering Col. of Medical Arts
B.S., Georgia State University

Thoroughman, Marla H. (1989)

Asst. Prof., Medical Lab. Tech.
College of Professional Studies
B.S., M.A., Morehead State Univ.
M.S., Morehead State University

Todt, David E. (1978)

Assoc. Professor, Biological Sciences
College of Arts and Sciences
B.S., M.En.S., Miami University
Ph.D., The Ohio State University

Trampe, George M. (1977)

Associate Professor, Chemistry
College of Arts and Sciences
B.S., University of Illinois
Ph.D., Purdue University

Valentine, Eugene J. (1990)

Assoc. Prof., Comm. Invlvmt./Phil.
College of Arts and Sciences
A.B., Harvard University
M.A., Ph.D., Michigan State Univ.

Walke, Jerry L. (1976)

Professor, Psychology
College of Arts and Sciences
B.S., Capital University
M.Ed., Ph.D., The Ohio State Univ.

Walker, Marsha L. (1987)

Asst. Prof., Office Administration
College of Professional Studies
B.S., M.A., The Ohio State Univ.

Ward, Carol M. (1992)

Asst. Prof., Assoc. Degree Nursing
College of Professional Studies
B.S.N., Western Reserve University
M.S.N., Case Western Reserve Univ.

Warfield, Kenneth W. (1983)

Coord., Environmental Eng. Tech.
Asst. Prof., Electromech. Eng. Tech.
College of Professional Studies
B.G.S., Ohio University

Wright, Janis L. (1997)

Sr. Instructor, Occupational Therapy
B.A., University of California, Davis
M.S., San Jose State University

Yang, Zhanbo (1989)

Associate Professor, Mathematics
College of Arts and Sciences
B.S., M.S., Heilongjing University
Ph.D., Auburn University

Yost, Carlson W. (1987)

Associate Professor, English
College of Arts and Sciences
B.S., Cornell University
B.A., Utica College of Syracuse Univ.
M.A., Ph.D., Texas A & M University

Yost, Paul (1996)

Sr. Instr., Computer Engineering Tech.
College of Professional Studies
B.S., Shawnee State Universit
M.S., University of Cincinnati

**Professor
Emeritus**

Hodgden, Betty
Wilson, Robert L., Ph.D.

Index

A

Academic Assessment, 38, 39
 Academic Calendar, 9-13
 Academic Dismissal, 40, 41
 Academic Integrity, 38
 Academic Policies, 37-46
 Academic Probation, 40
 Academic Programs, 53-57
 Accelerated Bachelor's Degree Programs, 60
 Accounting Technology, 109, 110
 class scheduling, 110
 Accreditations and Approvals
 associate degree nursing, 8, 124
 dental hygiene, 8, 125
 emergency medical technology, 8, 127
 medical laboratory, 8, 129
 occupational therapy (associate degree), 8, 131
 occupational therapy (bachelor's degree), 8, 120
 physical therapist, 8, 132
 radiologic technology, 8, 133
 respiratory therapy, 8, 134
 university, of the, 8
 ACT/SAT, 15
 Adding a Class, 42
 Administration, 245-247
 Administrative Hold, 38
 Admission Policies, 14-24
 ACT/SAT, 15
 advanced placement, 16
 applicants with GED, 16
 degree-seeking high school graduates, 15, 16
 health science students, 121-123
 high school students, 22-24
 international students, 20, 21
 non-degree students, 21-24
 senior citizens, 22
 transfer students, 16-20
 transient students, 21, 22
 undeclared major/undecided students, 16
 Advanced Placement, 16
 Advising, 42, 60, 61
 Alumni Association, 52
 Appeal Procedure
 dismissal from health science programs, 124
 financial aid, 35
 transfer credit, 18, 20
 Applicants with GED, 16-20
 Application, 23, 32
 financial aid, 32
 high school students, 23
 Application Fee, 30, 32
 Articulation and Transfer, State Policy, 17-20
 Arts and Humanities, Department of, 64-69
 academic advising, 42, 60, 61
 associate degrees, 61, 62
 bachelor of arts, English/humanities, 66, 67
 bachelor of fine arts, 67-69

degrees offered, 65
 elementary education certification, 67
 English sequence, 65
 new degree programs, 69
 telephone number, 4, 65
 visual arts education certification (K-12), 68, 69
 Arts and Sciences, College of, 58-100
 academic advising, 60, 61
 accelerated bachelor's degree programs, 60
 arts and humanities, department of, 64-69
 associate degree requirements, 61, 62
 baccalaureate degree requirements, 61
 course scheduling and offerings, 63
 degrees offered, 59, 60
 double major guidelines, 60
 faculty, 60, 247-251
 mathematical sciences, department of, 70-76
 minors, 61, 75, 82, 83, 89, 90, 115
 natural sciences, department of, 77-83
 pass/no-credit policy, 63
 preparation for elementary or secondary education certification, 63
 selecting and declaring a degree major, 60
 social sciences, department of, 84-90
 teacher education, department of 91-100
 telephone number, 4, 59
 Associate of Applied Business
 accounting, 109, 110
 business information systems, 112, 113
 business management, 111, 112
 legal assisting, 114, 115
 office administration technology, 113, 114
 Associate of Applied Science
 associate degree nursing, 124, 125
 computer aided design, 143
 dental hygiene, 125, 126
 electromechanical engineering technology, 144
 emergency medical technology, 126-129
 instrumentation and control engineering technology, 144, 145
 medical laboratory technology, 129, 130
 occupational therapy assistant, 130-132
 physical therapist assistant, 132
 plastics engineering technology, 145, 146
 radiologic technology, 132-134
 respiratory therapy, 134, 135
 Associate of Arts
 humanities concentration, 61, 62
 social science concentration, 61, 62
 Associate Degree Nursing, 124, 125
 accreditation, 124
 admission requirements, 121-123
 guidelines for appealing dismissal, 124
 Associate of Individualized Studies, 62, 63, 103
 Associate of Science
 mathematics concentration, 62
 natural science concentration, 62
 Athletics, Intercollegiate, 49, 50
 Athletics, Intramural, 50
 Attendance, 42
 Audit, 41

B

Baccalaureate Degree Requirements, 61
 Bachelor of Arts
 English/humanities, 66
 English/humanities, elementary education certification, 67
 history, 85, 86
 international relations, 86, 87
 social science, 87
 social science, elementary education certification, 87, 88
 social science, legal assisting (2 + 2), 88, 89
 Bachelor of Fine Arts, 67-69
 ceramics, drawing, and painting, 67, 68
 studio arts, 67, 68
 visual arts education certification (K-12), 68, 69
 Bachelor of Science
 biology, 78, 79
 business administration, general business, 106
 business administration, health management, 106, 107
 business administration, legal assisting (2 + 2), 107, 108
 business administration, management information systems, 108
 (2 + 2), 108, 109
 chemistry, 79, 80
 computer engineering technology, 139, 140
 environmental engineering technology, 141, 142
 mathematical sciences, 71-73
 medical laboratory science, 118, 119
 natural science, 80, 81
 natural science, elementary education certification, 81
 natural science, mathematics, 73-75
 natural science, mathematics, elementary and secondary education certification, 73-75
 occupational therapy, 120, 121
 plastics engineering technology, 142
 sports studies, athletic training, 98-100
 sports studies, sports management, 98, 99
 Bad Check Policy, 31
 BEARS Program, 153
 Biology, Bachelor of Science in, 78, 79
 Biology Minor, 82
 Biomedical Instrumentation Concentration, 145
 Board of Trustees, 245
 Bookstore, 50
 Budget Payment Plan, 30, 31
 Business Administration
 Department of, 104-116
 accounting technology, 109, 110
 associate degrees, 109-115
 bachelor of science, business administration, general business, 106
 bachelor of science, business administration, health management, 106, 107
 bachelor of science, business administration, legal assisting (2 + 2), 107, 108

bachelor of science, management
 information systems, 108, 109
 business information systems, 112, 113
 business management, 111, 112
 degrees offered, 105
 governmental accounting, 109
 health management, 106, 107
 individualized studies, 103
 legal assisting, 107, 108, 114, 115
 management accounting, 109
 minor, health management, 115
 new program, 116
 office administration, 113, 114
 public accounting and the CPA, 110
 special notes, 105, 106
 telephone number, 4, 105
 Business Information Systems, 112, 113
 Business Management Technology, 111, 112

C

CADD Certificate Program, 146
 CADD Sequence, 143
 Calendar, 9-13
 Campus Tours, 24
 Career Services, 48
 Ceramics, 67, 68
 Certificates
 computer aided drafting and design, 146
 computer technology, 148
 environmental science, 81, 82
 plastics engineering technology, 146, 147
 Changing Grades, 40
 Chemistry, Bachelor of Science in, 79, 80
 Children at the University, 42
 Class Ranking, 38
 College Level Examination Program (CLEP), 40
 College Work Study, 34
 Communication with the University, 4
 Composition Labs, 65
 Computer Aided Design, 143
 CADD electives, 143
 CADD sequence, 143
 minor, 147
 technical electives, 143
 Computer Aided Drafting and Design Certificate, Technician Program, 146
 Computer Engineering Technology, 139, 140
 degree requirements, 140
 Computer Proficiency Training, 46
 Computer Technology, Minor or Certificate, 148
 Concentration, Biomedical Instrumentation, 145
 Connection, The, 49
 Continuing Education, 45, 46
 Counseling, 48, 49
 Course Descriptions, 154-243
 explanation of abbreviations, 154
 explanation of prerequisites, 154
 Course Scheduling and Offerings, 63
 Credit by Arrangement, 30, 41
 Credit by Examination, 30, 39
 Credit for Military Educational Experiences, 40

D

Dean's List, 39
 Declaring a Major, 60
 Degrees Offered, 54, 59, 60, 65, 71, 78, 85, 93, 102, 105, 118, 138
 Dental Hygiene, 125, 126
 academic requirements, 125, 126
 accreditation, 125
 admission requirements, 121-123
 guidelines for appealing dismissal, 124
 job opportunities, 125
 Developmental Education, 44
 Dining, 50-52
 Disability Services, 48
 Dismissal, 40, 41
 Double Major Guidelines, 60
 Drawing, 67, 68
 Dropping a Class, 43

E

Economics Minor, 89
 Education, Elementary, 93-97
 certification requirements, 94
 course scheduling, 94
 eligibility criteria, 94
 English/humanities, 67, 95
 field fee, 31
 natural science, 81, 96
 natural science/mathematics, 74, 75, 95, 96
 pass/no-credit policy, 94
 preparation for, 63
 social science, 87, 88, 96
 Education Field Fee, 31
 Educational Opportunity Center, 153
 Electromechanical Engineering Technology, 144
 Emergency Medical Technology, 126-129
 academic requirements, 127
 accreditation, 127
 admission requirements, 121-123
 certification, 127
 employment opportunities, 127
 entrance requirements, 128
 guidelines for appealing dismissal, 124
 Employment, Student, 34
 English/Humanities, 66, 67
 Environmental Engineering Technology, 141, 142
 Environmental Science Minor, 82
 EOC, 153

F

Faculty, 42, 60, 103, 247-251
 Faculty Advising, 42, 60, 61
 Faculty Expectations and Responsibilities, 42
 Family Educational Rights and Privacy Act, 27
 Federal Parent Loan for Undergraduate Students (PLUS), 33
 Federal Supplemental Educational Opportunity Grant (SEOG), 33
 Fees, 30-32
 application, 30, 32
 bad check, 30, 31
 budget payment plan, 30, 31
 change order, 30, 32
 credentials evaluation, 31

credit by arrangement, 30
 credit by examination, 30
 educational field, 31
 full-time students, 30
 general, 30
 graduation, 30, 32
 graduation reapplication, 30
 health science, 31
 housing, 31
 international student orientation, 31
 lab fees, 154-243
 late payment, 30, 32
 miscellaneous, 30-32
 out-of-state, 30
 out-of-state/in-region, 30
 part-time students, 30
 refund of, 31, 32
 technology, 30
 transcript, 30, 32
 transcript, immediate action, 30, 32
 Financial Aid, 32-36
 application procedure, 32
 award disbursements, 33
 eligibility requirements, 32
 employment, 34
 grants, 33
 loans, 33, 34
 notification, 33
 satisfactory academic progress, 34-36
 scholarships, 33
 standards of progress policy, 34-36
 veterans, state programs, 34
 work study, 34
 Fine Arts, 67-69
 Free Application for Federal Student Aid (FAFSA), 32, 33

G

GED, Applicants with, 16
 General Education Program, 55-57
 mathematics requirement, 75, 76
 General Fee, 30
 Geography Minor, 89
 Goals of the University, 6, 7
 Governmental Accounting, 109
 Grade Point Ratio, 40
 Grade Reports, 43
 Grading/Awarding of Credit, 38
 Graduation Requirements, 43
 fee, 30, 32
 Graduation with Honors, 43, 44
 Grants, 33

H

Health Management, Bachelor of Science, 106, 107
 Health Management, Minor, 115
 Health Science Fee, 31
 Health Sciences, Department of, 117-136
 accreditation, 8, 118, 120, 124, 125, 127, 129, 131, 132, 133
 admission requirements, 121-123
 appealing dismissal, 124
 associate degree nursing, 124, 125
 associate of individualized studies, 103
 bachelor of science, medical laboratory science, 118, 119
 bachelor of science, occupational therapy, 120, 121

class scheduling, 123
 deadline, application materials, 123
 degrees offered, 118
 dental hygiene, 125, 126
 emergency medical technology, 126-129
 hospital clinical sites, 123
 medical laboratory technology, 129, 130
 new programs, 135, 136
 pass/no-credit policy, 124
 occupational therapy assistant, 130-132
 physical therapist assistant, 132
 radiologic technology, 132-134
 respiratory therapy, 134, 135
 selective admission criteria, 123
 telephone number, 4, 118
 High School Students, 22-24
 History, Bachelor of Arts in, 85, 86
 History of the University, 6
 Honors, Graduation, 43, 44
 Honors Program, 41
 Hospital Clinical Sites, 123
 Housing and Residence Life, 51, 52
 Housing Fees, 31

I

Identification Cards, 50
 Improper Registration, 26
 Incomplete Grades, 38
 Individualized Studies Degree, Associate of, 62, 63, 103
 Industrial and Engineering Technologies, Dept. of, 137-149
 associate of applied science, computer aided design, 143
 associate of applied science, electromechanical engineering technology, 144
 associate of applied science, instrumentation and control engineering technology, 144, 145
 associate of applied science, plastics engineering technology, 145, 146
 associate of individualized studies, 103
 bachelor of science, computer engineering technology, 139, 140
 bachelor of science, environmental engineering technology, 141, 142
 bachelor of science, plastics engineering technology, 142
 CADD sequence, 143
 certificate, computer aided drafting and design, 146
 certificate, computer technology, 148
 certificate, plastics engineering technology, 146, 147
 concentration, biomedical instrumentation, 145
 degrees offered, 138
 industrial and engineering technology programs at Shawnee State, 138, 139
 minor, computer aided design, 147
 minor, computer technology, 148
 minor, plastics engineering technology 147
 new programs, 149
 pass/no-credit policy, 139
 pre-engineering curriculum, 148, 149
 robotics option, 139
 telephone number, 4, 138
 Instructional Fee, 30

Instrumentation and Control Engineering Technology, 144, 145
 biomedical instrumentation concentration, 145
 Insurance, Student, 31
 International Students, 20, 21, 48
 International Study Programs, 42
 Internet Cafe, 51
 Internship Guidelines, 41

J

JOBS Student Retention Program, 49

L

Lab Fees, 31, 154-243
 Late Installment Fee, 30
 Late Payment, 30, 32
 Learning Center, 44
 Legal Assisting
 associate degree, 114, 115
 bachelor of arts, social science (2 + 2), 88, 89
 bachelor of science, business administration (2 + 2), 107, 108
 Southern State Community College (1 + 1), 115
 Library, 44, 45
 Loans, 33, 34

M

Mailing Address, 4
 Management Accounting, 109
 Management Information Systems
 bachelor of science, 108, 109
 bachelor of science (2 + 2), 108, 109
 Mathematical Sciences, Department of 70-76
 academic advising, 42, 60, 61
 associate degrees, 62
 bachelor of science, mathematical sciences, 71-73
 bachelor of science, natural science, 73-75
 degrees offered, 71
 elementary and secondary education certification, 73-75
 entrance into mathematics courses, 76
 general education mathematics requirement, 75, 76
 minor, mathematical sciences, 75
 telephone number, 4, 71
 Medical Laboratory Technology, 129, 130
 academic requirements, 129
 accreditation, 129
 admission requirements, 121-123, 129
 certification, 129
 employment opportunities, 129
 guidelines for appealing dismissal, 124
 health and physical ability requirements, 130
 scholarships, 129
 Military Educational Experience, Credit for, 40
 Minor
 biology, 82
 computer aided design, 147
 computer technology, 148
 economics, 89

environmental science, 82
 geography, 89
 health management, 115
 history, 89
 mathematical sciences, 75
 plastics engineering technology, 147
 political science, 90
 psychology, 90
 sociology, 90
 Minority Student Services, 48, 49
 Mission Statement, 6

N

National Association of Intercollegiate Athletics (N.A.I.A.), 50
 Natural Sciences, Department of, 77-83
 academic advising, 42, 60, 61
 associate degrees, 62
 bachelor of science, biology, 78, 79
 bachelor of science, chemistry, 79, 80
 bachelor of science, natural science, 80, 81
 certificate, environmental science, 81, 82
 degrees offered, 78
 elementary education certification, 81
 minor, biology, 82
 minor, environmental science, 82
 new programs, 83
 telephone number, 4, 78
 New Programs, 69, 83, 91, 100, 116, 135, 136, 149
 Non-Credit, 41
 Non-Degree Students, 21-24
 Nursing, 124, 125

O

Occupational Therapy, 120, 121
 admission requirements, 120, 121
 accreditation, 120
 degree requirements, 121
 Occupational Therapy Assistant, 130-132
 academic requirements, 131
 accreditation, 131
 admission requirements, 121-123
 clinical requirements, 131
 guidelines for appealing dismissal, 124
 Office Administration Technology, 113, 114
 Ohio Appalachian Center for Higher Education, 152, 153
 Ohio Appalachian Educational Opportunity Center, 153
 Ohio Instructional Grant, 33
 Orientation, 27
 Out of State Fee, 30
 Out of State/In Region Fee, 30
 Outreach Programs, 150-153

P

Painting, 67, 68
 Paramedic Program, 126-129
 Pass/No-Credit Policy, 39, 63, 124, 139
 Pell Grant, 33
 Physical Therapist Assistant, 132
 accreditation, 132
 admission requirements, 121-123
 guidelines for appealing dismissal, 124

Placement Testing, 27, 28
 Plastics Engineering Technology
 associate of applied science, 145, 146
 bachelor of science, 142
 minor in, 147
 one-year certificate, 146, 147
 Postsecondary Options Program, 22-24
 acceptance, notification, and reporting, 24
 application, 23
 college credit (Option A), 22
 eligibility, 22
 freshmen and sophomores, 24
 high school credit (Option B), 22, 23
 juniors and seniors, 22
 program continuation, 23
 registration, 23
 validation of credit, 24
 Pre-engineering Curriculum, 148, 149
 Prerequisites, 40, 154
 President's List, 39
 Previous Keyboard Training, 113
 Probation, Academic, 40
 Professional Studies, College of, 101-149
 associate of individualized studies, 103
 business administration, department of, 104-116
 degrees offered, 102
 faculty, 103
 health sciences, department of, 117-136
 industrial and engineering technologies, dept. of, 137-149
 new programs, 116, 135, 136, 149
 telephone number, 4, 102
 tutoring assistance, 103
 Professor Emeritus, 251
 Programs of Study, 54
 Public Accounting and the CPA, 110

R
 Radiologic Technology, 133, 134
 academic requirements, 133
 accreditation, 133
 admission requirements, 121-123
 guidelines for appealing dismissal, 124
 Reading Education Program, 98
 Refund of Fees, 31, 32
 Registration, 23, 25-28
 family educational rights and privacy act, 27
 high school students, 23
 improper, 26
 orientation, 27
 placement testing, 27, 28
 residency information, 26
 selective service, 26
 student advising and referral, 28
 Repeating Coursework, 40
 Residency Information, 26
 Respiratory Therapy, 134, 135
 academic requirements, 135
 accreditation, 134
 admission requirements, 121-123
 certification, 134
 employment opportunities, 134
 guidelines for appealing dismissal, 124
 Robotics, 139

S
 Satisfactory Academic Progress, 34-36
 Scholarships, 33
 Science (See Natural Sciences, Department of)
 Science Degree, Associate of, 62
 Secondary Education Certification, 63, 69, 73, 74, 91, 93-95, 97
 certification requirements, 94
 course scheduling, 94
 curriculum, 95
 eligibility criteria, 94
 field fee, 31
 mathematical sciences, 73, 74, 97
 natural science, mathematics, 73, 74, 97
 pass/no-credit policy, 94
 Secretarial (See Office Administration Technology)
 Selecting and Declaring a Major, 60
 Selective Admission Criteria, 123
 Selective Service Registration, 26
 Senior Citizens, 22
 Small Business Development Center, 46
 Social Sciences, Department of, 84-90
 academic advising, 42, 60, 61
 associate degrees, 61, 62
 bachelor of arts, history, 85, 86
 bachelor of arts, international relations, 86, 87
 bachelor of arts, social science, 87
 degrees offered, 85
 elementary education certification, 87, 88
 legal assisting (2 + 2), 88, 89
 minor, economics, 89
 minor, geography, 89
 minor, history, 89
 minor, political science, 90
 minor, psychology, 90
 minor, sociology, 90
 new degree programs, 91
 telephone number, 4, 85
 Social Science, Associate of Arts in, 61, 62
 Social Science, Bachelor of Arts in, 87
 Special Programs and Community Service, 45, 46
 Sports Management, 98, 99
 Sports Studies
 athletic training certification, 100
 athletic training concentration, 98-100
 sports management concentration, 98, 99
 Staff, 244-251
 Stafford Loan, 33, 34
 Standards of Progress, 34-36
 State Policy on Articulation and Transfer, 17-22
 Student Activities, 50-52
 Student Advising and Referral Services (STARS), 28, 49
 Student Development, 47-52
 Student Insurance, 31
 Student Load, 30
 Student Emergency Loan Fund, 34
 Student Support Services, 49
 Studio Arts, 67, 68
 Supplemental Education Opportunity Grant (SEOG), 33

T
 Talent Search, 151
 Teacher Education, Dept. of, 91-100
 athletic training certification, 100
 bachelor of science, sports studies, athletic training, 98-100
 bachelor of science, sports studies, sports management, 98, 99
 certification requirements, 94
 course scheduling, 94
 curriculum, 94, 95
 degrees and certification offered, 93
 elementary and secondary education certification, 93-98
 eligibility criteria, 94
 English/humanities major, 95
 fine arts, 97, 98
 mathematical sciences, 97
 natural science/mathematics major, 95-97
 natural science major, 96
 new programs, 100
 pass/no-credit policy, 94
 reading education program, 98
 social science major, 96
 telephone number, 4, 93
 visual arts certification, 97, 98
 Tech Prep Ohio South Consortium, 151, 152
 Technology Fee, 30
 Telephone Directory, 4
 Test of English as a Second Language (TOEFL), 20
 Tours, Campus, 24
 Transcripts, 30, 32, 43
 Transfer of Credit, 16-20
 appeal procedure, 18, 20
 Transfer Module, 19
 Transfer Students, 16-20
 Transient Students, 21, 22
 Trustees and Staff of Shawnee State, 244-251
 Tuition and Fees, 30-33
 Tutoring, 44, 103

U
 Undeclared Major/Undecided Student, 16
 University Center, 50, 51
 Upward Bound, 152

V
 Vern Riffe Center for the Arts, 65
 Veterans' Benefits, 34
 Vision Statements, 7
 Visitors to Class, 42
 Visual Arts Certification, 68, 69, 97, 98

W
 Welcome, 3
 Welcome Center, 50
 Withdrawal from the University, 43
 Withdrawing from Class, 43
 Work Study, 34

How to get to Shawnee State ...

... from Ashland, Ky.

Take Rt. 23 North across the U.S. Grant Bridge to Portsmouth. Exit right to Third Street.

... from Cincinnati

Take Rt. 32 East to Rt. 23 South. Stay on Rt. 23 to Third Street in Portsmouth. Turn left on Third Street.

... from Cleveland

Take I-71 South to Rt. 23 South (Circleville exit). Take Rt. 23 South to Third Street in Portsmouth. Turn left on Third Street.

... from Columbus

Take Rt. 23 South to Third Street in Portsmouth. Turn left on Third Street.

... from Dayton

Take Rt. 35 South to Rt. 23 South. Stay on Rt. 23 to Third Street in Portsmouth. Turn left on Third Street.

... from Huntington, W. Va.

Take Rt. 52 West to Rt. 23 South in Portsmouth. Stay on Rt. 23 to Third Street. Turn left on Third Street.

... from Maysville, Ky.

Take Rt. 546 East to Rt. 10 East. Take Rt. 10 to Rt. 23 North across the U.S. Grant Bridge to Portsmouth. Exit right to Third Street.

... from Toledo

Take I-75 South to Rt. 23 (Findlay). Take Rt. 23 South to Third Street in Portsmouth. Turn left on Third Street.

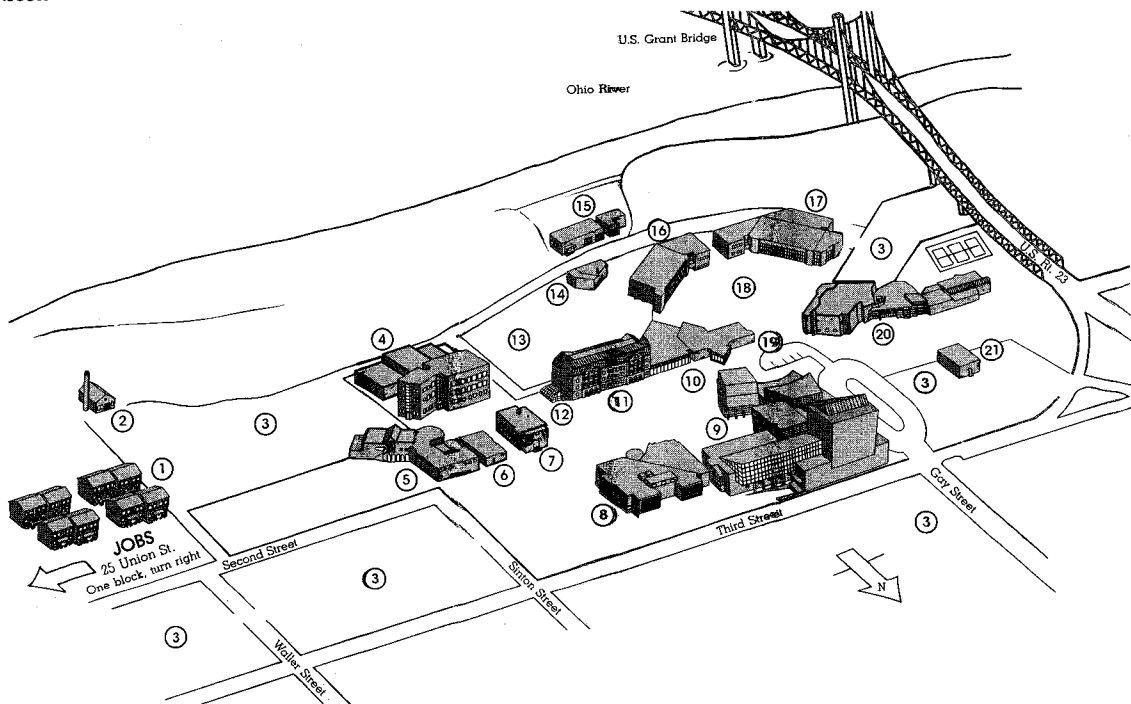
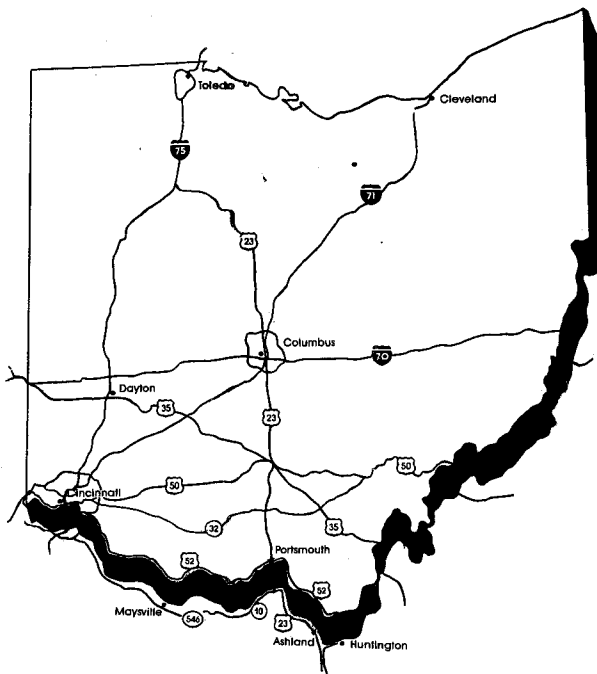

- 1 University Housing
- 2 Art Annex
- 3 Student/Visitor Parking
- 4 Advanced Technology Center
- 5 University Center
- 6 Bookstore
- 7 1004 Building

- 8 Library
- 9 Vern Riffe Center for the Arts
- 10 Commons Building
- 11 Massie Hall
- 12 Waller Conservatory (greenhouse)
- 13 Faculty/Staff Parking
- 14 Maintenance/Heating

- 15 Purchasing
- 16 Kricker Hall
- 17 Health Sciences Building
- 18 Alumni Green
- 19 Executive Parking (special pass only)
- 20 James A. Rhodes Athletic Center
- 21 Office Annex

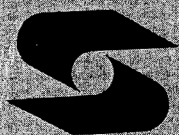

Shawnee State University
940 Second Street
Portsmouth, Ohio 45662-4344

Office of Admission